

LTE Industrial Router

ICR-2031

USER MANUAL



ADVANTECH

© 2022 Advantech Czech s.r.o. No part of this publication may be reproduced or transmitted in any form or by any means, electronic or mechanical, including photography, recording, or any information storage and retrieval system without written consent. Information in this manual is subject to change without notice, and does not represent a commitment on the part of Advantech.

Advantech Czech s.r.o. shall not be liable for incidental or consequential damages resulting from the furnishing, performance, or use of this manual.

All brand names used in this manual are the registered trademarks of their respective owners. The use of trademarks or other designations in this publication is for reference purposes only and does not constitute an endorsement by the trademark holder.

Used symbols



Danger – Information regarding user safety or potential damage to the router.



Attention – Problems that can arise in specific situations.



Information, notice – Useful tips or information of special interest.

GPL licence

Source codes under GPL licence are available at <https://icr.advantech.cz/source-code> address.



Contents

1	Product Overview	2
1.1	Product Introduction	2
1.2	Product Usage Examples	3
1.3	Hardware Overview	5
1.4	Order Codes	6
1.5	Package Contents	7
1.6	Product Dimensions	8
1.7	Mounting Recommendations	9
1.8	Wall Mounting	10
1.9	DIN Rail Mounting	11
1.10	Product Label	12
2	Hardware Functionality	13
2.1	SIM Card Slot	13
2.2	Cellular Antennas	14
2.3	Ethernet Interfaces	14
2.4	Power Supply	15
2.5	I/O Port Interfaces	16
2.6	LED Status Indication	17
2.7	Reset Functions	18
3	First Use	20
3.1	Powering up the Router	20
3.2	Router Configuration	20
4	Technical Specifications	22
4.1	Basic Parameters	22
4.2	Standards and Regulations	23
4.3	Type Tests and Environmental Conditions	24
4.4	Parameters of Cellular Module	25
4.5	Parameters of I/O Ports	26
4.6	System Configuration	26
	Appendix A: Troubleshooting	27
	Appendix B: Customer Support	30
	Appendix C: Regulatory & Safety Information	31

List of Figures

1	Access to the Internet from LAN	3
2	Backed up Access to the Internet	3
3	Using VPN Tunnel	4
4	Serial Gateway	4
5	Hardware Overview of the Router	5
5	Product Dimensions – Front View	8
6	Product Dimensions (with wall mounting clip) – Top View	8
7	Screwed Wall Mounting Clip	10
8	Position of the DIN Rail Clip	11
9	Removing Router from the DIN Rail	11
10	Label Example	12
5	SIM Card Insertion	13
6	Ethernet Connector Pinout	14
7	Connection of Power Supply	15
8	Position of the Grounding Screw	15
9	I/O Connector Pinout	16
10	Functional Scheme of the Binary Interface	16
11	Resetting the Router	18
12	Router’s Web Interface	21

List of Tables

1	Hardware Overview of the Router	6
2	Order Codes Overview	6
1	Contents of Package	7
2	Ethernet Connector Pinout Description	14
3	Power Supply Pinout	15
4	I/O Ports Pinout	16
5	LED Status Indication	17
6	Overview of Router Reboot and Reset	19
7	Basic Parameters	22
8	Standards and Regulations	23
9	Type Tests and Environmental Conditions	24
10	Technical Parameters of Cellular Module	25
11	Electrical Characteristics of Binary Inputs	26
12	System Configuration	26

1. Product Overview

1.1 Product Introduction

Industrial cellular router ICR-2031 is designed for wireless communication in the mobile networks that make use of traditional cellular technologies.

The primary purpose of this router is its use in the Category 4 (**Cat.4**) services on the cellular **LTE** network. Cat.4 rated router is capable of achieving typical speeds in 4G coverage areas where the network is enabled with 20 MHz of contiguous spectrum.

The peak **downlink** data rate for Category 4 is approximately **150 Mbps**. In the **uplink**, LTE Category 4 provides a peak data rate of **50 Mbps**. The router is equipped with one **Ethernet port** and with one **digital input** together with one **digital output**.

The router supports **VPN tunnel** creation using various protocols to ensure safe communications. The router provides diagnostic functions which include automatic monitoring of the wireless and wired connections, automatic restart in case of connection losses, and a hardware watchdog that monitors the router status.

With open Linux platform and wide possibilities of programming customer SW applications in **Python, C/C++**. The Advantech existing app library **Router Apps** (User modules) with apps already developed to enhance specific router functionality including industrial protocol conversions and support of IoT platforms such as **MS Azure, Cumulocity, ThingWorx**, and others are supported on the router.



Examples of possible applications

- mobile office
- security system
- telematic
- telemetric
- remote monitoring
- vending and dispatcher machines

1.2 Product Usage Examples

The router is primarily intended for these four basic situations:

I. Access to the Internet from LAN

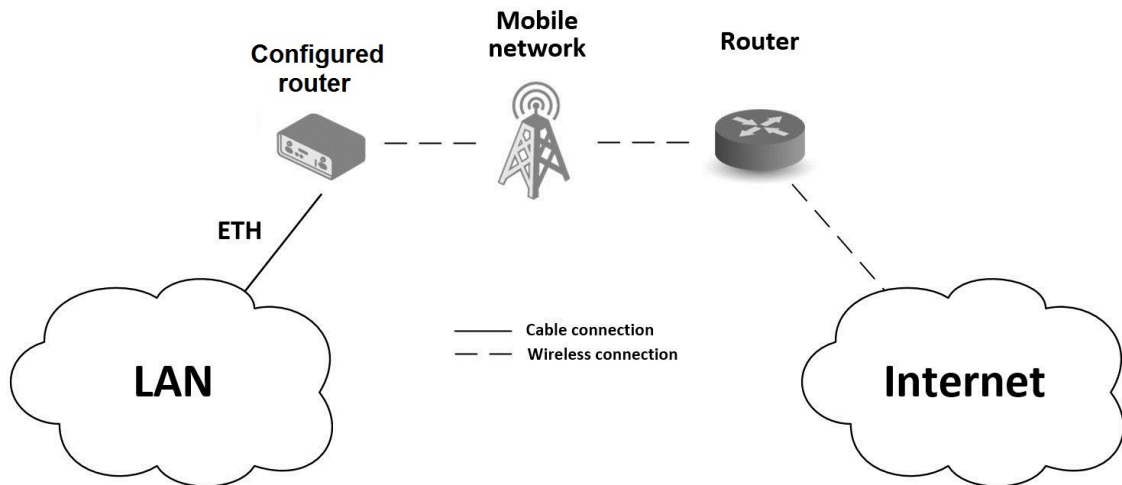

Figure 1: Access to the Internet from LAN

II. Backed up access to the Internet (from LAN)

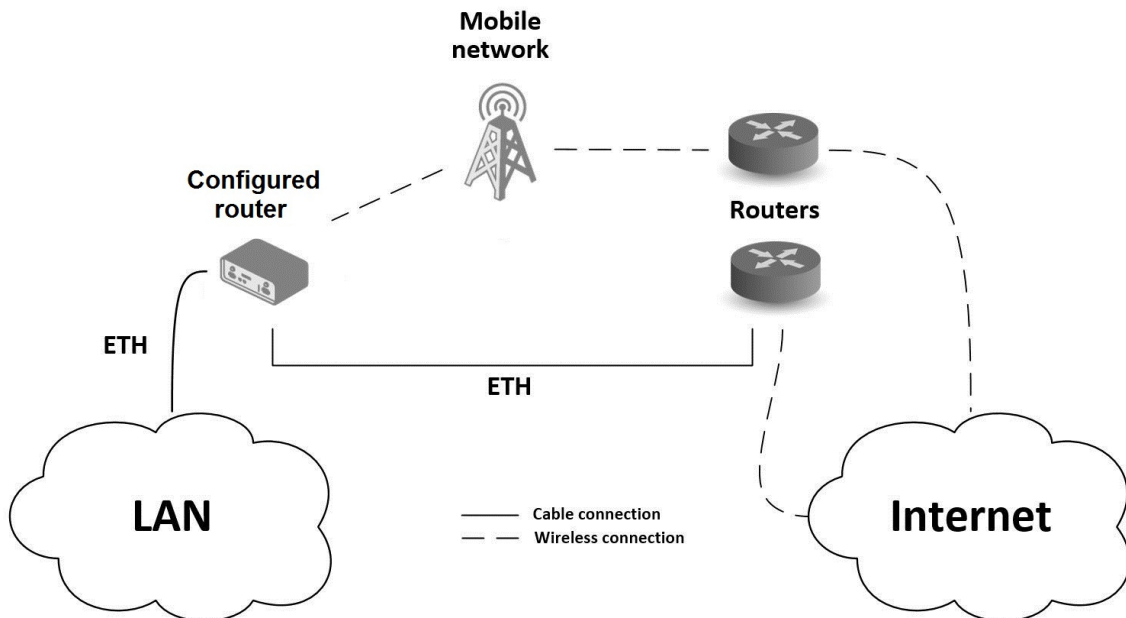

Figure 2: Backed up Access to the Internet

III. Secure networks interconnection or using VPN

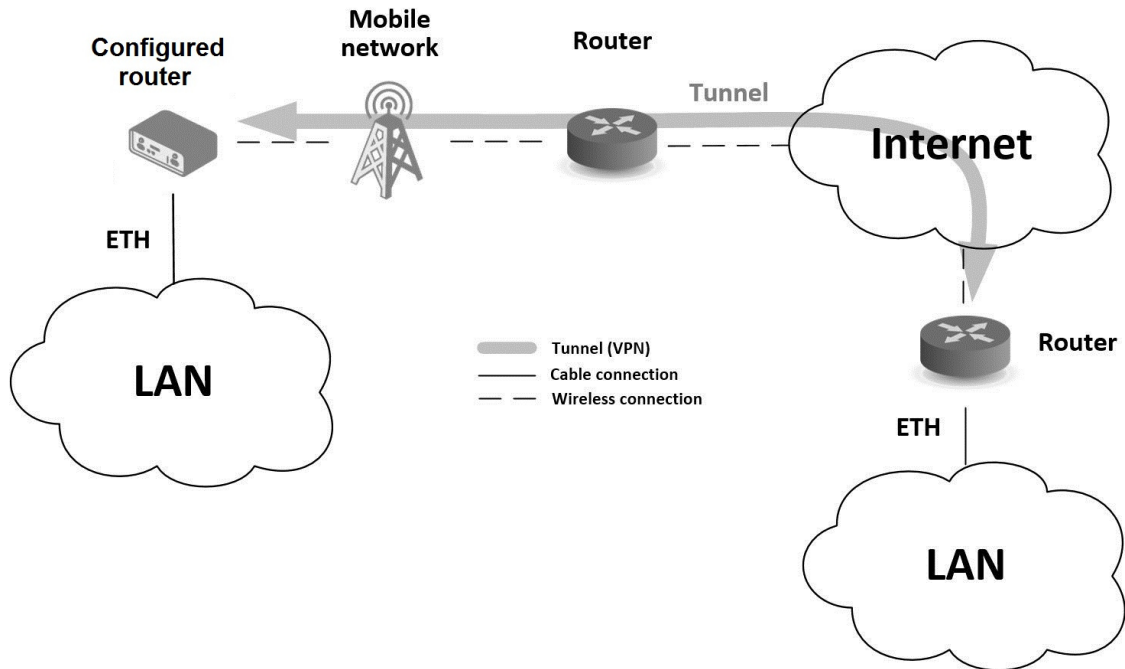

Figure 3: Using VPN Tunnel

IV. Serial Gateway

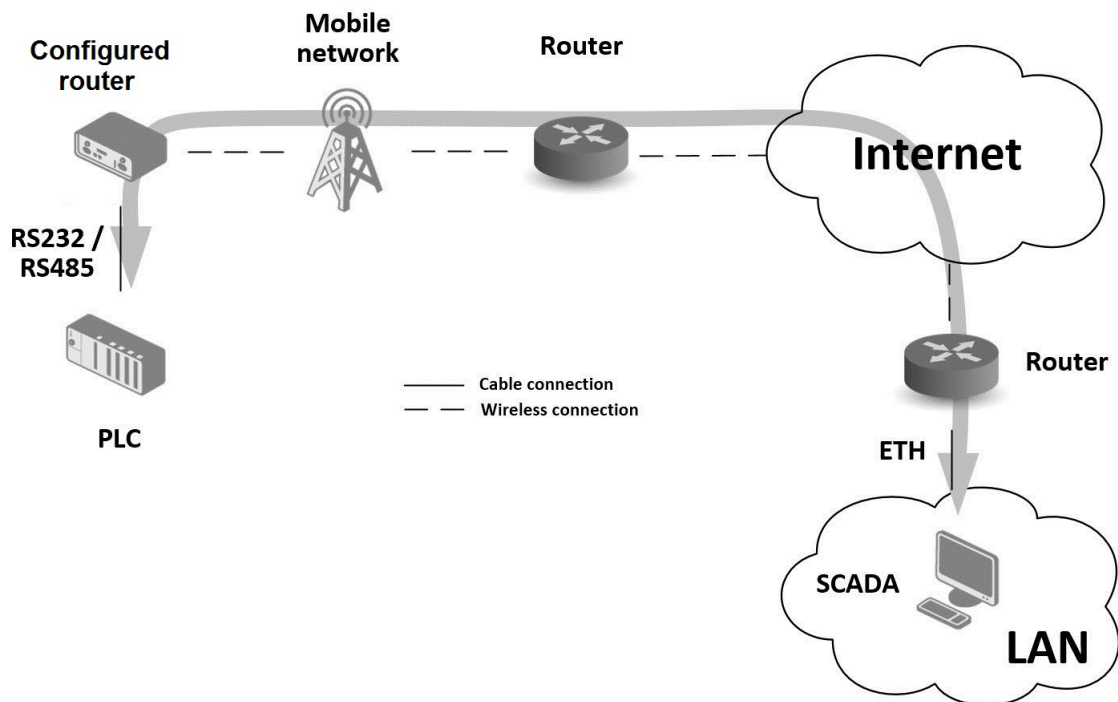

Figure 4: Serial Gateway

1.3 Hardware Overview

The router case preview is shown in Figure 5. A short description of hardware parts of the router is listed in Table 1, including the links to the chapters with a detailed description.

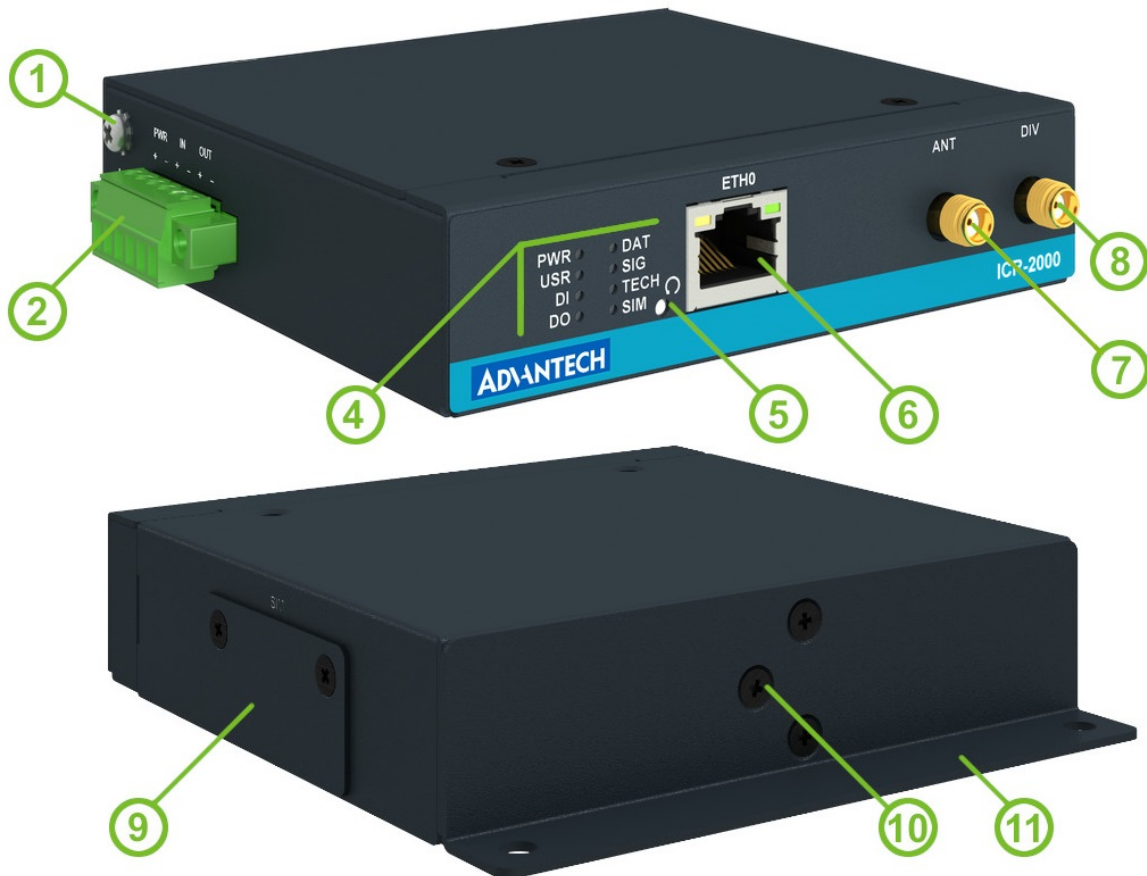

Figure 5: Hardware Overview of the Router

#	Item/Caption	Type	Description
1	Grounding screw	M3	Pay attention to proper grounding, see Chapter 2.4.
2	PWR	6-pin terminal	Power supply socket, see Chapter 2.4.
2	IN/OUT	6-pin terminal	Binary input & output interfaces, see Chapter 2.5.
4	LEDs	-	Status LED indication, see Chapter 2.6.
5	RST	-	Button to reboot the router or to restore the default configuration, see Chapter 2.7.

Continued on the next page

Continued from previous page

#	Item/Caption	Type	Description
6	ETH0	RJ45	100 MB Ethernet connection for the first LAN, see Chapter 2.3.
7	ANT	SMA	Connector for the first main antenna of the cellular module, see Chapter 2.2
8	DIV	SMA	Connector for the first diversity antenna of the cellular module, see Chapter 2.2
9	SIM slot	micro-SIM	One SIM card slot, see Chapter 2.1.
10	DIN clip	-	DIN rail clip, not included as standard accessories, See Chapter 1.9.
11	Wall clip	-	Wall mounting clip, included as standard accessories, see Chapter 1.8.

Table 1: Hardware Overview of the Router

1.4 Order Codes

Order codes overview is shown in the table below.

Product name	Order code	Features – interfaces
ICR-2031	ICR-2031	LTE Cat.4 with 3G/2G fallback module, 64 MB NOR Flash, 1x ETH, 1x Binary Input, 1x Binary Output, 1x SIM reader

Table 2: Order Codes Overview

1.5 Package Contents

The standard set of router includes items listed in the following table:





Item#	Description	Figure	Q'ty
1	Router		1 pcs
2	Wall mounting clip with screws		1 set
3	6-pin terminal block for power supply, digital input and digital output (deployed on the router)		1 pcs
4	Printed <i>Quick Start Guide</i> notes		1 pcs

Table 1: Contents of Package

1.6 Product Dimensions

For the dimensions of the product see the figures below. Note that all sizes are measured in millimeters.

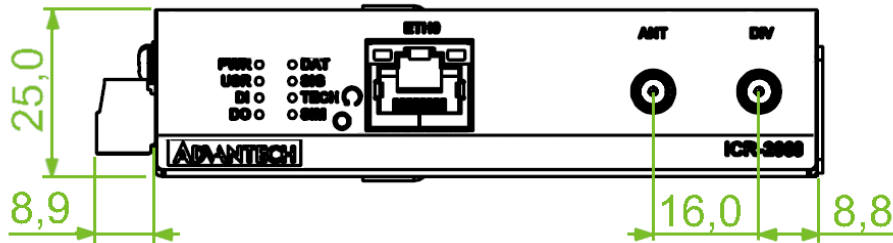

Figure 5: Product Dimensions – Front View

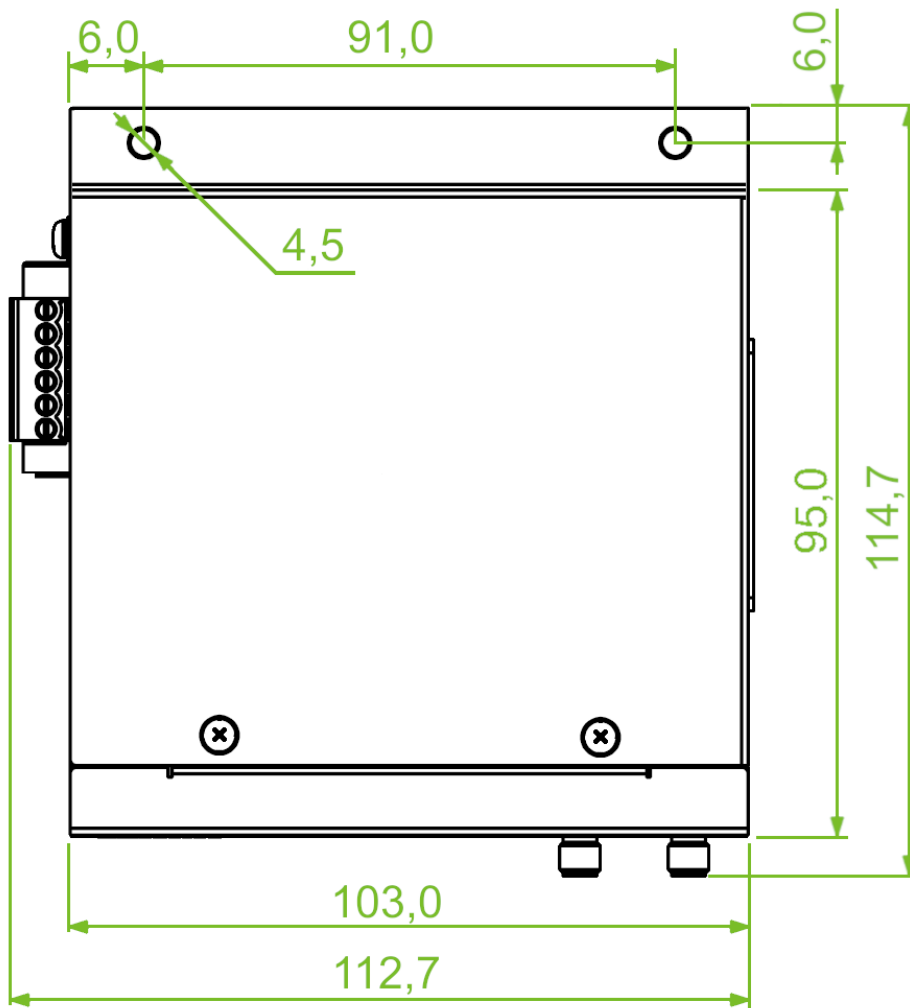

Figure 6: Product Dimensions (with wall mounting clip) – Top View

1.7 Mounting Recommendations

The router can be placed:

- on a flat surface,
- on a wall using the wall mounting clip (see Chapter 1.8),
- on a DIN rail EN 60715 with the metal DIN rail clip (see Chapter 1.9)

For most applications with a built-in router within a switchboard, it is possible to recognize two kinds of environments:

- A non-public, industry environment of low voltage with high interference,
- a public environment of low voltage and without high interference.

For both of these environments, it is possible to mount the router to a switchboard, after which there is no need to have examination immunity or issues in connection with EMC according to EN 61439-1:2011.



In compliance with the EN 61439-1:2011 specification, it is necessary to observe the following assembly instructions for a router attached to a switchboard:

- For whip antennas it is recommended to observe a minimum distance of 6 cm from cables and metal surfaces on every side in order to avoid interference. When using an external antenna separate from the switchboard it is necessary to fit a lightning conductor.
- When mounting a router on sheet-steel we recommend using a cable antenna.
- For all cables, we recommend to bind the bunch, and for this we recommend:
 - The length of the bunch (the combination of power supply and data cables) should be a maximum 1.5 m. If the length of data cables exceeds 1.5 m or if the cable is leading towards the switchboard, we recommend installing surge protectors.
 - Data cables must not have a reticular tension of ~ 230 V/50 Hz or ~ 120 V/60 Hz.
- Sufficient space must be left between each connector for the handling of cables,
- To ensure the correct functioning of the router we recommend the use of an earth-bonding distribution frame for the grounding of the grounding screw, see Chapter 2.4.

1.8 Wall Mounting



The wall mounting clip is supplied with the router as standard accessories.

The router can be screwed to a wall (or another surface) using the wall mounting clip. There are two wholes on the clip with a diameter of 4 millimeters. For detailed information about the mounting dimensions see Figure 6 in Chapter 1.6.



When mounting the wall mounting clip, tighten the screws with max. torque of 0.4 Nm.



Figure 7: Screwed Wall Mounting Clip

1.9 DIN Rail Mounting



The DIN rail clip is not supplied with the router as standard accessories, but it can be ordered by the order code *BB-DIN-ICR32*.

The DIN rail clip is suitable for a DIN rail according to EN 60715 standard only. The default position of the clip is shown in Figure 8.



When mounting the DIN rail clip, tighten the screws with max. torque of 0.4 Nm.



Figure 8: Position of the DIN Rail Clip

To remove the router from the DIN rail it is necessary to lightly push down the router so that the bottom part of the DIN rail clip hitched to the DIN rail get out of this rail and then fold out the bottom part of the router away from the DIN rail, see Figure 9.

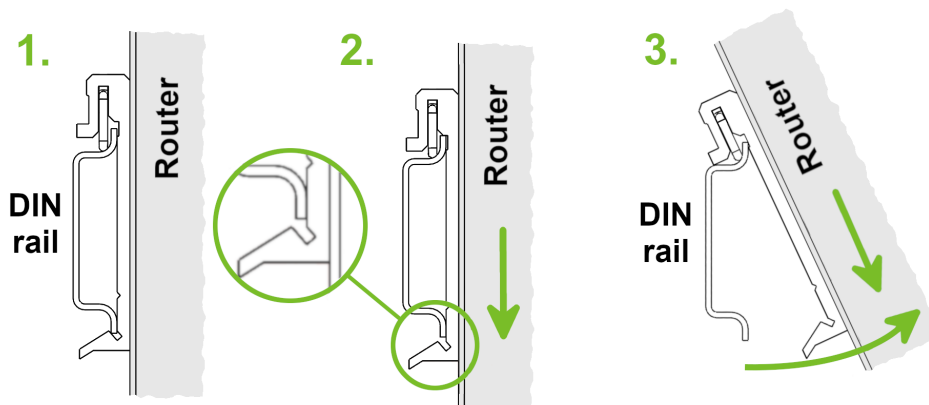

Figure 9: Removing Router from the DIN Rail

1.10 Product Label

An example of the product label, with all the information printed on it, is in the figure below.

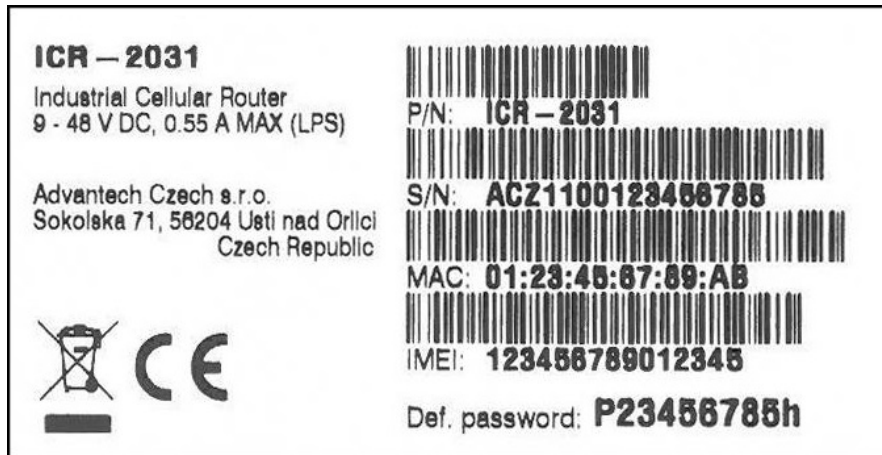

Figure 10: Label Example

2. Hardware Functionality

See Chapter 1.3 for the product hardware overview. Table 1 lists a short description of the hardware, including the links to the chapters with a detailed description.

2.1 SIM Card Slot

Slot for one SIM card is located on the right panel of the router under a metal cover. It is necessary to insert an activated SIM card, to work properly. If the PIN is required for the SIM, enter it in the router's web interface. The SIM cards may have different APNs (Access Point Names) adjusted. The SIM card changing procedure is described below.



Type of SIM cards: micro-SIM (3FF) 15.0 x 12.0 x 0.76 mm.

Inserting the SIM card:

- Always disconnect the router from the power supply before handling the SIM card.
- Unscrew two screws on the SIM card cover and remove the cover.
- To remove an inserted SIM card, use the flat end of a spudger, or your fingernail, press the SIM card slightly into its slot until you hear a click. After hearing this click, release the card, and it will pop out of its slot.
- To insert a SIM card push card into the slot until it clicks into place.
- Place back the cover and fix it by two screws.

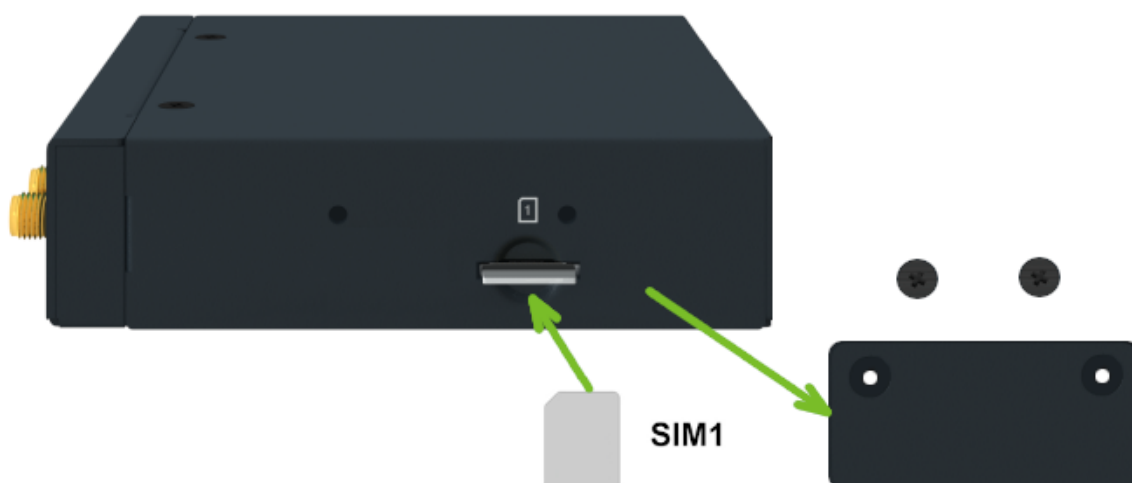

Figure 5: SIM Card Insertion

2.2 Cellular Antennas

Main (ANT) and diversity (DIV) antennas can be connected to the router using the SMA connectors located on the front panel.



Do not run the router without connected cellular antenna connected to the main antenna connectors as the energy from the transmission is effectively reflected by the open end and can damage the equipment.



Recommended tightening moment for screwing the antenna to the SMA connector is 0.9 Nm.



The diversity antenna improves the radio capability of the router at low signal strength.

2.3 Ethernet Interfaces



The maximum length of the cables connected to the Ethernet ports is 30 meters to meet the EMC immunity conditions.

The panel socket of RJ45 is used for Ethernet interface. The pinout of the socket is shown in Figure 6 and described in Table 2.

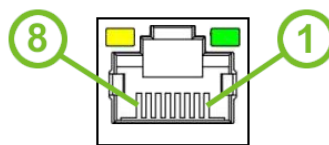

Figure 6: Ethernet Connector Pinout

Pin	Signal mark	Description
1	TXD+	Transmit Data – positive pole
2	TXD-	Transmit Data – negative pole
3	RXD+	Receive Data – positive pole
4	—	—
5	—	—
6	RXD-	Receive Data – negative pole
7	—	—
8	—	—

Table 2: Ethernet Connector Pinout Description



The isolation barrier of the Ethernet ports against the ground is 1500 V.

2.4 Power Supply

The pins of power supply are physically connected to the 6-pin terminal block panel socket located on the left panel. The connection of power supply is shown in Figure 7 and described in Table 3.

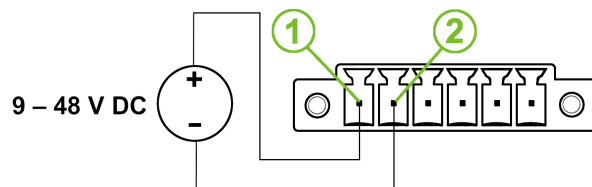

Figure 7: Connection of Power Supply

Pin	Signal mark	Description
1	PWR(+)	Positive pole of DC supply voltage (+9 to +48 V DC)
2	PWR(-)	Negative pole of DC supply voltage

Table 3: Power Supply Pinout

Required power supply voltage for the router is between +9 V and +48 V DC, see the connection scheme on Figure 7. Protection against reversed polarity without signaling is built into the router. For correct operation it is necessary that the power source is able to supply a peak current of 1 A.



Unit has to be supplied by a power supply specified as a Limited Power Source (LPS) or CEC/NEC Class 2 source of supply.

The metal case of the router is not connected to the negative pole of the power supply (common pole). If recommended for the installation environment, protect the router by grounding it properly by the grounding screw on the right panel, see Figure 8.



Figure 8: Position of the Grounding Screw

2.5 I/O Port Interfaces



The maximum length of wires connected to the I/O ports is 3 meters to meet the EMC immunity conditions.

The pins of I/O interface are physically connected to the 6-pin terminal block panel socket located on the left panel. The pinout of one binary input and one binary output is shown in Figure 9 and described in Table 4.

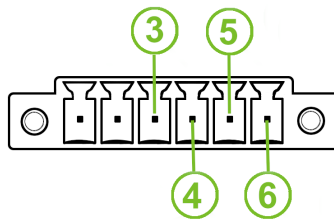

Figure 9: I/O Connector Pinout

Pin	Signal mark	Description
3	IN(+)	The binary input (positive pole)
4	IN(-)	The binary input (negative pole)
5	OUT(+)	The binary output (positive pole)
6	OUT(-)	The binary output (negative pole)

Table 4: I/O Ports Pinout

The I/O user interface is designed for binary input processing and binary output control. For detailed electrical parameters see Chapter 4.5. The functional scheme of connection for the binary input and binary output is in Figure 10.

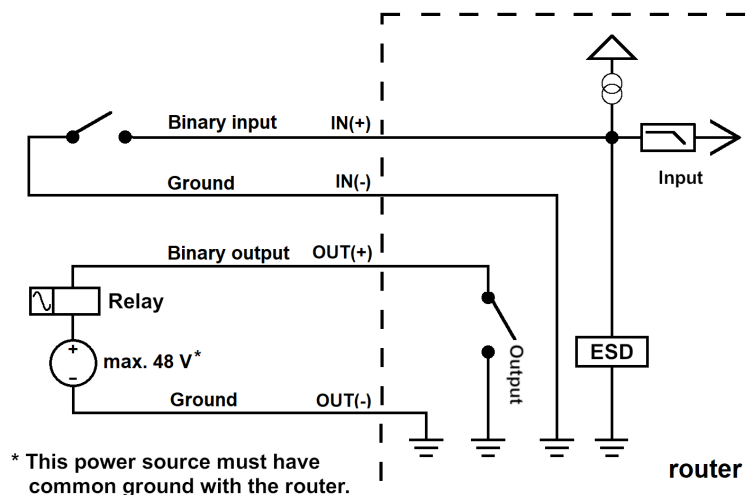

Figure 10: Functional Scheme of the Binary Interface

2.6 LED Status Indication

There are LED indicators on the front panel of the router to provide router status information. Moreover, ETH connector, has two additional LEDs providing information about the port status.

Caption	Color	State	Description
PWR	Green	On	Starting of the router
	Green	Blinking	Router is ready
	Green	Fast blinking	Updating firmware
USR	Green		Function of this LED diode can be selected by user
DI	Green	On	The first binary input is active.
DO	Green	On	The second binary input is active.
DAT	Green	Blinking	Communication in progress on radio channel
SIG	Green	On	Good signal
		Blinking	Fair signal
		Fast blinking	Poor signal
TECH	Green	On	4G technology is used by the active SIM
		Blinking	3G technology is used by the active SIM
		Fast blinking	2G technology is used by the active SIM
SIM	Green	On	SIM is selected
		Fast blinking	SIM card problem (missing SIM or PIN not entered)
ETH0	Green	On	Selected 100 Mbps bit rate
ETH1	Green	Off	Selected 10 Mbps bit rate
ETH0	Orange	On	The network cable is connected
	Orange	Blinking	Data transmission
	Orange	Off	The network cable is not connected

Table 5: LED Status Indication

2.7 Reset Functions

The *RST* button on the front panel can be used in three different situations:

- **Reboot the router:** Hold the *RST* button for less than 4 seconds, the router will be restarted.
- **Factory reset** – restore the default configuration: Hold the *RST* button for more than 4 seconds. The *PWR* LED turns off and on again. We recommend holding down the *RST* button for 1 second after turning on the *PWR* LED on the front panel.
- **Emergency factory reset** – If the router is unable to boot up due to the bad configuration, turn off the router (disconnect the power supply). Push and hold the *RST* button, turn on the router and hold the *RST* button for at least 10 seconds. This will return the configuration of the router to default one.



It is recommended to back up the settings of the router configuration, prior to performing the factory reset of the router. Note that resetting of the router reset the whole configuration to the default state.



It is necessary to use a narrow screwdriver or any other small tool to press the *RST* button.

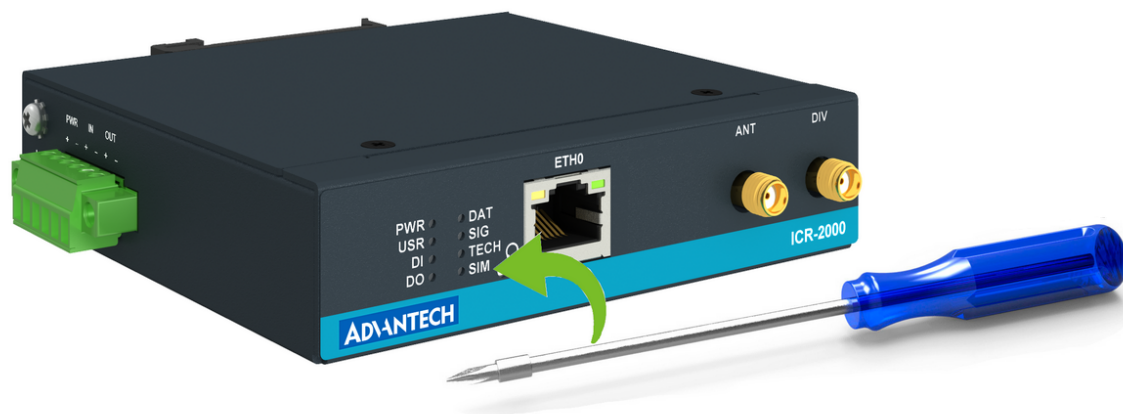

Figure 11: Resetting the Router

Action	Router behavior	Trigger events – options
Reboot	Turns off and then turns on the router	<ul style="list-style-type: none"> • Disconnect and reconnect the power. • Send text <i>reboot</i> via SMS to SIM card number put in your router (your phone number has to be authorized – see the configuration manual). • Press the <i>Reboot</i> menu item in the web interface. • Press the <i>RST</i> button and hold it less than 4 seconds.
Factory Reset	Restores the default configuration and reboots the router	<ul style="list-style-type: none"> • Hold the <i>RST</i> button for more than 4 seconds. • If it does not help (router does not start at all), turn off the router (power supply). Push and hold the <i>RST</i> button, then turn on the router and hold the <i>RST</i> button for more than 10 seconds.

Table 6: Overview of Router Reboot and Reset

3. First Use

3.1 Powering up the Router

The router will start up when a power supply is connected to it. By default, the router will automatically log on to the default APN of the inserted SIM card. The DHCP server will assign an addresses to the devices connected through the Ethernet port ETH0.

3.2 Router Configuration

Initial router configuration can be made via a web browser running on your PC. Here you can perform router monitoring, configuration, and administration. First, connect the PC to the default LAN interface as described in the *Start Guide* application note [1]. To get the router interface, enter the <https://192.168.1.1> address in a web browser. Please note that usage of the HTTPS protocol for secure communication over the network is required.

By default, there is just the **root user** account created on the router. See the **product label** on the router for its **default password**. Log in to the web interface by the *root* user and his password. If logged in successfully, the user will have access to the router web interface, see Figure 12. See the configuration manual [2] of the router for a detailed description and examples of the router configuration.



After logging on to the device for the first time, we strongly recommend changing the default password due to security reasons.



For security reasons, we highly recommend updating the router's firmware to the latest version regularly. Downgrading the firmware to an older version than the production version or uploading firmware intended for a different device may cause the malfunction of the device.



All routers have the *WebAccess/DMP* client pre-installed by default. The activated client periodically uploads router identifiers, its configuration, and cellular network statistics to the *WebAccess/DMP* server. See the configuration manual [2], chapter *Basic Information* -> *WebAccess/DMP Configuration*, for more information.

ICR-2031 LTE Router

Name: N/A
Location: N/A

Status	General Status
<ul style="list-style-type: none"> General Mobile WAN Network DHCP IPsec WireGuard DynDNS System Log 	<div style="background-color: #e6f2ff; padding: 2px; margin-bottom: 5px;">Mobile Connection</div> <p>SIM Card : 1st IP Address : 10.80.0.86 IPv6 Address : Unassigned Rx Data : 588 B Tx Data : 1.9 KB Uptime : 0 days, 8 hours, 43 minutes</p> <p style="text-align: center;">» More Information «</p> <div style="background-color: #e6f2ff; padding: 2px; margin-bottom: 5px;">ETH0</div> <p>IP Address : 10.64.0.101 / 255.255.252.0 IPv6 Address : fd00:a40:1101 / 56 MAC Address : 02:AD:FF:00:01:01 Rx Data : 166.2 KB Tx Data : 38.5 KB</p> <p style="text-align: center;">» More Information «</p> <div style="background-color: #e6f2ff; padding: 2px; margin-bottom: 5px;">Peripheral Ports</div> <p>Binary Input : On Binary Output : Off</p> <div style="background-color: #e6f2ff; padding: 2px; margin-bottom: 5px;">System Information</div> <p>Firmware Version : 6.3.4 (2022-01-04) BETA #1506 Serial Number : ACZ119900001015 Hardware UUID : N/A Profile : Standard Time : 2022-01-06 09:58:32 Uptime : 0 days, 8 hours, 43 minutes</p> <p style="text-align: center;">» Licenses «</p>
<ul style="list-style-type: none"> Configuration Ethernet VRRP Mobile WAN PPPoE Backup Routes Static Routes Firewall NAT OpenVPN IPsec WireGuard GRE L2TP pPTP Services Scripts Automatic Update 	
<ul style="list-style-type: none"> Customization User Modules 	
<ul style="list-style-type: none"> Administration Users Change Profile <li style="color: red;">Change Password Set Real Time Clock Set SMS Service Center Unlock SIM Card Unblock SIM Card Send SMS Backup Configuration Restore Configuration Update Firmware Reboot Logout 	

Figure 12: Router's Web Interface



A detailed description of the router settings in the web interface can be found in the configuration manual of the router.

4. Technical Specifications

4.1 Basic Parameters

Router parameters		
Temperature range	Operating Storage	-40 °C to +75 °C -40 °C to +85 °C
Humidity	Operating Storage	5 to 95 % relative humidity non condensing 5 to 95 % relative humidity non condensing
Altitude	Operating	2000 m / 70 kPa
Degree of protection		IP30
Supply voltage		9 to 48 V DC
Battery for RTC		CR2032X (non-replaceable)
Consumption	Idle Average Peak	2 W 3,5 W 10 W
Dimensions of device w/o clip		103 x 95 x 25 mm
DIN rail clip (optional part) specification		DIN 35 mm, EN 60715
Weight	Box w/o clip	315 g
Antenna connectors		2 SMA connectors for LTE – 50 Ω
User interface	ETH0: 1 port PWR & I/O	RJ-45 socket for 10/100 Mbps Ethernet 6-pin socket for power supply and I/O interfaces

Table 7: Basic Parameters

4.2 Standards and Regulations

The router complies with the following standards and regulations:

Standards and regulations	
Radio	EN 301 511, EN 301 908-1 13.1.1, EN 301 908-2, EN 301 908-13
EMC	EN 301 489-1, EN 301 489-52, EN 61000-4-2, EN 61000-4-3, EN 61000-4-4, EN 61000-4-5, EN 61000-4-6, EN 61000-4-11
Safety	EN 62368-1:2018, IEEE 802.3
National	CE, UKCA compliant
Environmental	REACH, RoHS3 and WEEE compliant

Table 8: Standards and Regulations

4.3 Type Tests and Environmental Conditions

Phenomena	Test	Description	Test levels
ESD	EN 61000-4-2	Contact discharge Air discharge	± 6 kV (crit. A) ± 8 kV (crit. A)
RF field AM modulated	EN 61000-4-3	Enclosure	10 V/m (crit. A) (80 – 6000 MHz)
Fast transient	EN 61000-4-4	Signal ports DC port Ethernet ports AC/DC adapter	± 1 kV (crit. A) ± 1 kV (crit. A) ± 1 kV (crit. A) ± 2 kV (crit. A)
Surge	EN 61000-4-5	DC port	± 0.5 kV L-G (crit. A), ± 0.5 kV L-L (crit. A)
RF conducted	EN 61000-4-6	DC port Ethernet ports Serial ports	10 V/m (crit. A) (0.15 – 80 MHz)
Radiated emission	EN 55032	Enclosure	Class B
Conducted emission	EN 55032	DC power port Ethernet ports Serial ports	Class B Class B Class B
Dry heat	EN 60068-2-2	Operating Storage	+75 °C, 40 % rel. humidity +85 °C, 40 % rel. humidity
Cold	EN 60068-2-1	Operating Storage	-40 °C -40 °C
Damp heat	EN 60068-2-78		95 % rel. humidity (+40 °C)
Variation of temperature	EN 60068-2-14		-40 °C / +75 °C (3h / 3h)

Table 9: Type Tests and Environmental Conditions

4.4 Parameters of Cellular Module

Technical parameters of cellular module	
LTE parameters	LTE: LTE Cat.4, 3GPP Rel. 11 FDD frequencies: B28A (700 MHz), B20 (800 MHz), B8 (900 MHz), B7 (2600 MHz), B3 (1800 MHz), B1 (2100 MHz) TDD frequencies: B41 (2500 MHz), B40 (2300 MHz), B38 (2600 MHz) Bit rates: up to 150 Mbps (DL), 50 Mbps (UL)
HSPA+/UMTS parameters	Supported frequencies: B8 (900 MHz), B1 (2100 MHz) Bit rates: 42 Mbps (DL) / 5.76 Mbps (UL)
EDGE/GPRS parameters	Supported frequencies: B8 (900 MHz), B3 (1800 MHz) Bit rates: max. 296 kbps (DL) / 236.8 kbps (UL)

Table 10: Technical Parameters of Cellular Module

Antenna Requirements

- VSWR: <2:1 (Antenna input impedance response as function of frequency. This shows the antenna resonances and its bandwidth).
- SMA: 50 Ω
- For good diversity performance, the primary and secondary antennas should have different polarizations.

4.5 Parameters of I/O Ports

Electrical characteristics of the binary inputs are in Table 11. Status of the binary input is reported in the GUI on *General Status* page or can be retrieved in the Shell via `io get bin0` command.

get command output	Voltage	Web interface status
0	$\leq 0.8\text{ V}$ (0.5 mA))	On
1	$\geq 2\text{ V}$	Off

Table 11: Electrical Characteristics of Binary Inputs

The maximum binary output load is **100 mA** at **9 – 48 V**.

4.6 System Configuration

The main parameters of the system are listed in Table 12.

Other technical parameters	
CPU architecture	ARM926EJ-S
CPU frequency	600 MHz
CPU power	4,72 DMIPS/MHz
Flash memory	64 MB NOR Flash <ul style="list-style-type: none"> • 12 MB for Router Apps • 2 MB for customer data
RAM size	128 MB
Watchdog	HW Watchdog
RTC	Battery Backup RTC

Table 12: System Configuration

Appendix A: Troubleshooting

If you cannot connect to the router from your PC, your network card may be configured in such a way that it is not possible to connect to the router. Take one or more of the following steps in order to solve the problem:



- Make sure your PC's network card is configured to obtain the IP address from the DHCP server (by default the DHCP server is running in the router).
- Connect the router to the PC via Switch.
- Connect the router to the PC, start the router first and then start the PC after the router's initialization.

Ethernet connection fails or is not establishing.

- *It is possible to turn auto negotiation off and set a rate and duplex manually on the Ethernet interface of the router. Available on "LAN Configuration" page in the router.*

Mobile WAN connection fails.

- *Check the signal power ("Mobile WAN status" page). If the signal power is weak, you will have to use a better antenna. If the neighbouring cells have a similar signal strength, you will need to use a directional antenna. For proper operation, the signal levels have to be good.*
- *Try to enable automatic ping from the router, which will check the connection when there are no data running and in the case of a failed ping, restart the connection. This can be done on the "Mobile WAN Configuration" page in the router in the "Check connection" section. "Enable + bind" option is to ensure the ping goes always through Mobile WAN network interface.*

Mobile WAN connection cannot be established.

- *Check the "Mobile WAN Configuration" – APN, name, password and IP address (all can be blank).*
- *Try to enter the SIM card PIN – verify that the SIM card has the PIN code entered. Available on "Unlock SIM Card" page in the "Administration" section.*
- *In a private APN it is not recommended to get the DNS settings from operator (on "Mobile WAN" page)*
- *Go to "System Log" page in "Status" section and observe where the error occurs.*

I cannot connect from the Internet to the device behind the router. I have NAT enabled.

- *The device's gateway has to be configured so it points to the router.*

 **I can't access my Web server placed behind the router over NAT.**

- *The remote HTTP access to the router has to be disabled on "NAT Configuration" page in the router. Also enable "Send all remaining incoming packets to default server" feature and fill in the IP address of your Web server. On the Web server, the default gateway has to be the IP address of the router.*

 **DynDNS doesn't work.**

- *With private APN this will not work.*
- *If the same IP address is recorded in your canonic name as a dynamically assigned address, it means that the operator is using NAT or a firewall.*
- *You can verify NAT using ping to your server with static address and then compare with router's IP address.*
- *You can verify a Firewall by accessing remotely to the router's Web interface.*
- *The operator may not provide the address of DNS server and without DNS server's address it is impossible to connect to the dyndns.org server. The following messages will be shown in the System Log:*
 - *DynDNS daemon started*
 - *Error resolving hostname: no such file or directory*
 - *Connect to DynDNS server failed*

 **L2TP or IPSec isn't establishing.**

- *Check the "System Log" page for error messages.*

 **IPSec tunnel establishes but the communication does not run.**

- *Probably there are bad routing rules defined in the connected devices, or the default gateway.*

 **I switched the router to offline mode by SMS message, but the router is in online mode after reboot.**

- *SMS messages do not change the router configuration. They remain in effect only until the router is rebooted.*

Serial communication is not working.

- *Verify that the router model supports serial communications. Also verify the serial communication settings. To do so, open the router's configuration menu via the web browser, select the appropriate "Expansion Port" from "Configuration" part of the menu and verify the settings.*

Is the router Cisco compatible? Can I use the Cisco configuration?

- *No, the Firmware in the router (Conel OS) is based on Linux with BusyBox. Thus the Cisco configuration cannot be used. But network connections are defined by standards so connecting the router to the Cisco or other networking devices is possible and will be compatible.*

FTP or SFTP does not work

- *FTP will work on v2 routers only. You can use SFTP on all routers to transfer files to/from the router. If having troubles with FTP on v2 routers, make sure you have FTP enabled: "Configuration" section, "Services", "FTP". Then you can connect with any client on port 21 with name and password same as for the Web interface. If having troubles with SFTP, make sure you have SSH enabled: "Configuration" section, "Services", "SSH". Then you can connect with any client on port 22 with name and password same as for the Web interface.*

How can I connect to the router's command line? (SSH, Telnet)

- *You can use SSH on all routers or Telnet on v2 routers only. SSH is enabled by default, but you can verify in Web interface in "Configuration" section, "Services", "SSH". Then connect with any SSH client on port 22 of the router. User and password is the same as for the Web interface. Telnet on v2 routers can be enabled here: "Configuration" section, "Services", "Telnet".*

Appendix B: Customer Support

Customer Support for Europe

Advantech Czech s.r.o.

Sokolska 71
562 04, Usti nad Orlici,
Czech Republic

Phone: +353 91 792444
Fax: +353 91 792445
E-mail: iiotcustomerservice@advantech.eu
Web: www.advantech.com

Customer Support for NAM

Advantech B+B SmartWorx

707 Dayton Road
Ottawa, IL 61350 USA

Phone: +1-800-346-3119 (Monday – Friday, 7 a.m. to 5:30 p.m. CST)
Fax: +1-815-433-5109
E-mail: support@advantech-bb.com
Web: www.advantech-bb.com

Customer Support for Asia

Phone: +886-2-2792-7818 #1299 (Monday – Friday, 9 a.m. to 5:30 p.m. UTC+8)
Fax: +886-2-2794-7327
E-mail: icg.support@advantech.com.tw
Web: www.advantech.com

Appendix C: Regulatory & Safety Information

Safety Notices



Please, observe the following instructions:

- The router must be used in compliance with all applicable international and national laws and in compliance with any special restrictions regulating the utilization of the router in prescribed applications and environments.
- To prevent possible injury and damage to appliances and to ensure compliance with all relevant provisions, use only the original accessories. Unauthorized modifications or the use of unapproved accessories may result in damage to the router and/or a breach of applicable regulations. Unauthorized modifications or use of unapproved accessories may void the warranty.
- The router can not be opened.
- Turn off the router and disconnect it from power supply before handling the SIM card.
- **Caution!** This equipment is not suitable for use in locations where children are likely to be present. The SIM card could be swallowed by small children.
- Power supply must not exceed 48 V DC max.
- Do not expose the router to extreme ambient conditions. Protect the router against dust, moisture and high temperature.
- Only routers with appropriate certification and labelling should be used in locations where flammable and explosive materials are present, including gas stations, chemical plants, or locations in which explosives are used. We remind users of the duty to observe the restrictions concerning the utilization of radio devices at such places.
- Switch off the router when travelling by plane. Utilization of the router on a plane may endanger the operation of the plane or interfere with the mobile telephone network, and may be unlawful. Failure to observe these instructions may result in the suspension or cancellation of telephone services for the respective client and/or may result in legal sanctions.
- When using the router in close proximity to personal medical devices, such as cardiac pacemakers or hearing aids, you must proceed with heightened caution.
- The router may cause interference when used in close proximity to TV sets, radio receivers or personal computers.
- It is recommended that you create an appropriate copy or backup of all important settings that are stored in the memory of the device.



Product Disposal Instructions

The WEEE (Waste Electrical and Electronic Equipment: 2012/19/EU) directive was introduced to ensure that electrical/electronic products are recycled using the best available recovery techniques to minimize the impact on the environment. This product contains high quality materials and components which can be recycled. At the end of its life this product MUST NOT be mixed with other commercial waste for disposal. The device contains a battery. Remove the battery from the device before disposal. The battery in the device needs to be disposed of apart accordingly. Check the terms and conditions of your supplier for disposal information.

Appendix D: Related Documents

- [1] Advantech Czech: **Start Guide** (QSG-0011-EN)
- [2] Advantech Czech: **ICR-2000, ICR-2400, ICR-2500, ICR-2600 – Configuration Manual** (MAN-0059-EN)



Product-related documents can be obtained on *Engineering Portal* at www.icr.advantech.cz address.

 Hereby, Advantech Czech s.r.o. company declares that the radio equipment narrated in this user's guide complies with EU Directive **2014/53/EU**.

The full text of the EU Declaration of Conformity is available at the following internet address:
icr.advantech.cz/eudoc