

LTE Industrial Router

# ICR-1601

CONFIGURATION MANUAL



**ADVANTECH**

## Used Symbols

 *Danger* – Information regarding user safety or potential damage to the router.

 *Attention* – Problems that can arise in specific situations.

 *Information, notice* – Useful tips or information of special interest.

 *Example* – Example of function, command or script.



# Contents

- 1. Introduction..... 6**
  - 1.1 Basic HW Information.....6
  - 1.2 Installation & Maintenance Notice.....7
    - 1.2.1 System Requirements.....7
    - 1.2.2 Warnings.....7
    - 1.2.3 Hot Surface Caution.....7
  - 1.3 Access to the Web Configuration .....8
- 2. Basic Network..... 9**
  - 2.1 WAN & Uplink.....9
    - 2.1.1 Physical Interface.....9
    - 2.1.2 Connection Setup .....13
  - 2.2 LAN & VLAN .....36
    - 2.2.1 Ethernet LAN.....36
    - 2.2.2 VLAN .....38
    - 2.2.3 DHCP Server .....51
  - 2.3 WiFi .....58
    - 2.3.1 WiFi Configuration .....59
    - 2.3.2 Wireless Client List.....71
    - 2.3.3 Advanced Configuration .....72
    - 2.3.4 Uplink Profile .....74
  - 2.4 GNSS.....79
  - 2.5 IPv6 .....84
    - 2.5.1 IPv6 Configuration .....84
  - 2.6 Port Forwarding .....89
    - 2.6.1 Configuration .....90
    - 2.6.2 Virtual Server & Virtual Computer .....91
    - 2.6.3 Special AP & ALG.....96
    - 2.6.4 DMZ & Pass Through .....100
  - 2.7 Routing.....102
    - 2.7.1 Static Routing.....103
    - 2.7.2 Dynamic Routing.....106
    - 2.7.3 Routing Information .....111
  - 2.8 DNS & DDNS.....112
    - 2.8.1 DNS & DDNS Configuration .....112
- 3. Object Definition .....116**
  - 3.1 Scheduling.....116
    - 3.1.1 Scheduling Configuration.....116
  - 3.2 External Server.....118

|           |                            |            |
|-----------|----------------------------|------------|
| 3.3       | Certificate .....          | 120        |
| 3.3.1     | My Certificate .....       | 120        |
| 3.3.2     | Trusted Certificate .....  | 126        |
| <b>4.</b> | <b>Security .....</b>      | <b>132</b> |
| 4.1       | VPN .....                  | 132        |
| 4.1.1     | IPSec.....                 | 133        |
| 4.1.2     | OpenVPN.....               | 144        |
| 4.1.3     | L2TP.....                  | 152        |
| 4.1.4     | PPTP .....                 | 157        |
| 4.1.5     | GRE.....                   | 161        |
| 4.2       | Firewall.....              | 166        |
| 4.2.1     | Packet Filter .....        | 166        |
| 4.2.2     | URL Blocking .....         | 170        |
| 4.2.3     | MAC Control .....          | 174        |
| 4.2.4     | IPS .....                  | 177        |
| 4.2.5     | Options.....               | 180        |
| <b>5.</b> | <b>Administration.....</b> | <b>184</b> |
| 5.1       | Configure & Manage.....    | 184        |
| 5.1.1     | Command Script .....       | 185        |
| 5.1.2     | TR-069.....                | 189        |
| 5.1.3     | SNMP .....                 | 194        |
| 5.1.4     | Telnet & SSH .....         | 205        |
| 5.2       | System Operation .....     | 208        |
| 5.2.1     | Password & MMI .....       | 208        |
| 5.2.2     | System Information .....   | 211        |
| 5.2.3     | System Time.....           | 212        |
| 5.2.4     | System Log.....            | 213        |
| 5.2.5     | Backup & Restore .....     | 217        |
| 5.2.6     | Reboot & Reset.....        | 220        |
| 5.3       | Diagnostic .....           | 221        |
| 5.3.1     | Diagnostic Tools.....      | 221        |
| 5.3.2     | Packet Analyzer.....       | 222        |
| <b>6.</b> | <b>Service.....</b>        | <b>225</b> |
| 6.1       | Cellular Toolkit.....      | 225        |
| 6.1.1     | Data Usage .....           | 226        |
| 6.1.2     | SMS .....                  | 228        |
| 6.1.3     | SIM PIN .....              | 231        |
| 6.1.4     | Network Scan.....          | 235        |
| 6.2       | Event Handling.....        | 237        |
| 6.2.1     | Configuration .....        | 238        |

|            |                                     |            |
|------------|-------------------------------------|------------|
| 6.2.2      | Managing Events.....                | 242        |
| 6.2.3      | Notifying Events.....               | 245        |
| <b>7.</b>  | <b>Status .....</b>                 | <b>248</b> |
| 7.1        | Basic Network .....                 | 248        |
| 7.1.1      | WAN & Uplink Status.....            | 248        |
| 7.1.2      | LAN & VLAN Status .....             | 252        |
| 7.1.3      | WiFi Status .....                   | 253        |
| 7.1.4      | DDNS Status .....                   | 255        |
| 7.2        | Security .....                      | 256        |
| 7.2.1      | VPN Status .....                    | 256        |
| 7.2.2      | Firewall Status.....                | 259        |
| 7.3        | Administration .....                | 262        |
| 7.3.1      | Configure & Manage Status.....      | 262        |
| 7.4        | Statistics & Report .....           | 264        |
| 7.4.1      | Connection Session.....             | 264        |
| 7.4.2      | Device Administration .....         | 265        |
| 7.4.3      | Cellular Usage .....                | 266        |
| <b>8.</b>  | <b>GPL Written Offer .....</b>      | <b>267</b> |
| <b>9.</b>  | <b>Recommended literature .....</b> | <b>272</b> |
| <b>10.</b> | <b>Customers Support .....</b>      | <b>273</b> |
| 10.1       | Customer Support for NAM.....       | 273        |
| 10.2       | Customer Support for Europe .....   | 273        |
| 10.3       | Customer Support for Asia .....     | 273        |

# 1. Introduction

Cellular router ICR-1601 is designed for wireless communication in the mobile networks that make use of traditional cellular technologies. The primary purpose of this router is its use in the newest Category 4 (Cat.4) services on the cellular LTE network.

LTE Category 4 (Cat.4) is the next step in 4G LTE device capability. Cat.4 rated ICR-1601 routers are capable of achieving better typical speeds in 4G coverage areas where the network is enabled with 20 MHz of contiguous spectrum. The peak downlink data rate for a Category 4 is approximately 150 Mbps. Also in the uplink, LTE Category 4 provides a peak data rate of 50 Mbps.

Below is the list of the main router's features:

- **Compact design:** Built-in LTE and configurable Ethernet WAN/LAN can provide Ethernet machine easy connection to internet/intranet by LTE or high reliable fail-over wired/LTE connection.
- **Dual SIM:** Embedded 3G/4G with configurable dual-SIM achieve location free multi-ISP fail-over requirement.
- **Versatile Cellular:** Preferred service selection can simplify uplink setting; toolkit function of data usage can control budget; configurable SMS command is useful and efficient for remote administration.
- **Complete Network:** Built-in NAT/Port Forward/Routing/IPv6 are compatible to existing IP network.
- **Highly Security:** Various VPN protocol & scenario can setup secure intranet; built-in Firewall prevents malicious attacks; ACL & Authentication by MAC /User enhances secure access.
- **Flexible Administration:** Web UI is used for basic setting; programmable CLI and Command Script are used for advanced configuration; system can be managed by NMS based on TR-069.
- **Smart Event Handling:** Mechanism to manage action for pre-defined events by administrator. Events can be triggered or notified based on System/Interface status change, SMS, SNMP trap, or e-mail.

## 1.1 Basic HW Information

As a standard, the ICR-1601 router is equipped with two Fast Ethernet 10/100 Mbps interfaces, two readers for SIM cards and reader for MicroSD card (log storage). The router can be equipped with WiFi module or with GPS module. This router is supplied in a metal bracket casing. For more detail see *User Manual for ICR-1601* [2].



Before you install and use this product, please read this manual in detail for fully exploiting the functions of this product.

## 1.2 Installation & Maintenance Notice

### 1.2.1 System Requirements

|   |   |
|---|---|
| <b>Network Requirements</b>                         | <ul style="list-style-type: none"> <li>• A fast Ethernet RJ45 cable</li> <li>• 3G/4G cellular service subscription</li> <li>• IEEE 802.11b/g/n wireless client</li> <li>• 10/100 Ethernet adapter on PC</li> </ul>  |
| <b>Web-based Configuration Utility Requirements</b> | <p><b>Computer with the following:</b></p> <ul style="list-style-type: none"> <li>• Windows®, Macintosh, or Linux-based operating system</li> <li>• An installed Ethernet adapter</li> </ul> <p><b>Browser requirements:</b></p> <ul style="list-style-type: none"> <li>• Internet Explorer 6.0 or higher</li> <li>• Chrome 2.0 or higher</li> <li>• Firefox 3.0 or higher</li> </ul> |

### 1.2.2 Warnings

- Only use the power adapter that comes with the package. Using a different voltage rating power adaptor is dangerous and may damage the product.
- Do not open or repair the case yourself. If the product is too hot, turn off the power immediately and have it repaired at a qualified service center.
- Place the product on a stable surface and avoid using this product and all accessories outdoors.

### 1.2.3 Hot Surface Caution



- The surface temperature for the metallic enclosure can be very high!
- Especially after operating for a long time, installed at a closed cabinet without air conditioning support, or in a high ambient temperature space.
- DO NOT touch the hot surface with your fingers while servicing!

## 1.3 Access to the Web Configuration

 **Attention!** Wireless transmissions work only when you activate the SIM card for data traffic and insert it into the router. Remove the power source before inserting the SIM card.

You may use the web interface to monitor, configure and manage the router. To do so, enter the router's IP address in your browser. The default address is <http://192.168.1.1><sup>1</sup>. Please note that the DHCP server is enabled by default.

When you see the login page, enter the user name and password and then click *Login* button. The default username is "**admin**". The default password is "**admin**". Change the default password as soon as possible!

 For increased security of the network connected to the router, change the default router password.

---

<sup>1</sup> The default LAN IP address of this gateway is 192.168.1.1. If you change it, you need to login by using the new IP address.



## 2. Basic Network

### 2.1 WAN & Uplink

| Interface Name | Physical Interface | Operation Mode | Action                              |
|----------------|--------------------|----------------|-------------------------------------|
| WAN-1          | 3G/4G              | Always on      | <input type="button" value="Edit"/> |
| WAN-2          | -                  | Disable        | <input type="button" value="Edit"/> |

The router provides multiple WAN interfaces to let all client hosts in Intranet of the router access the Internet via ISP. But ISPs in the world apply various connection protocols to let routers or user's devices dial in ISPs and then link to the Internet via different kinds of transmit media.

#### 2.1.1 Physical Interface

| Interface Name | Physical Interface | Operation Mode | Action                              |
|----------------|--------------------|----------------|-------------------------------------|
| WAN-1          | 3G/4G              | Always on      | <input type="button" value="Edit"/> |
| WAN-2          | -                  | Disable        | <input type="button" value="Edit"/> |

| Item               | Setting                                    |
|--------------------|--|
| Physical Interface | 3G/4G                                      |
| Operation Mode     | Always on                                  |
| VLAN Tagging       | <input type="checkbox"/> Enable 0 (1-4095) |

ICR-1601 routers are usually equipped with various WAN interfaces to support different WAN connection scenario for requirement. You can configure the WAN interface one by one to get proper internet connection setup. **Refer to the product specification for the available WAN interfaces in the product you purchased.**

The first step to configure one WAN interface is to specify which kind of connection media to be used for the WAN connection, as shown in "Physical Interface" page.

In "Physical Interface" page, there are two configuration windows, "Physical Interface List" and "Interface Configuration". "Physical Interface List" window shows all the available physical interfaces. After clicking on the "Edit" button for the interface in "Physical Interface List" window the "Interface Configuration" window will appear to let you configure a WAN interface.

### Physical Interface:

- **Ethernet WAN:** The router has one RJ45 WAN port that can be configured to be WAN connections. You can directly connect to external DSL modem or setup behind a firewall device.
- **3G/4G WAN:** The router has one built-in 3G/4G cellular as WAN connection. For each cellular WAN, there are 1 or 2 SIM cards to be inserted for special failover function.



- Please **POWER OFF** the router before you insert or remove SIM card!
- The SIM card can be damaged if you insert or remove SIM card while the router is in operation.

- **WiFi Uplink WAN:** For the product with WiFi Uplink function, one WiFi module can be configured to be WAN connections. For the WiFi module with Uplink function activated, you can further create some uplink profiles for ease of connecting to an uplink network.

### Operation Mode:

There are three option items "Always on", "Failover", and "Disable" for the operation mode setting.

**Always on:** Set this WAN interface to be active all the time. When two or more WAN are established at "Always on" mode, outgoing data will through these WAN connections.

### Failover:

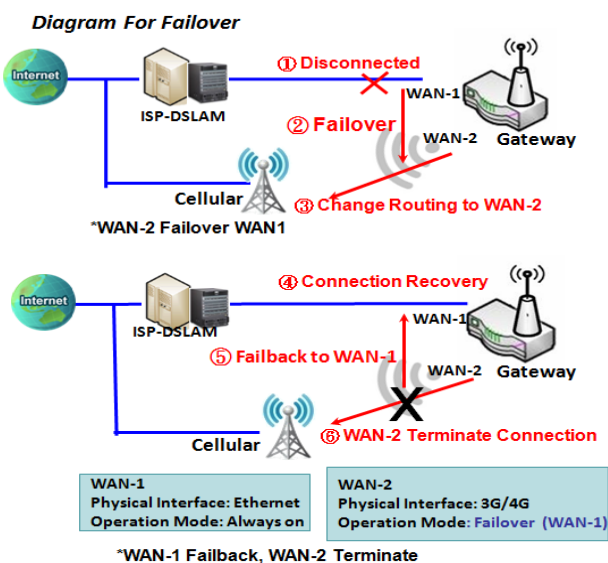

A failover interface is a backup connection to the primary. That means only when its primary WAN connection is broken, the backup connection will be started up to substitute the primary connection.

As shown in the diagram, WAN-2 is backup WAN for WAN-1. WAN-1 serves as the primary connection with operation mode "Always on". WAN-2 won't be activated until WAN-1 disconnected. When WAN-1 connection is recovered back with a connection, it will take over data traffic again. At that time, WAN-2 connection will be terminated.

## Seamless Failover:

Diagram For Seamless Failover

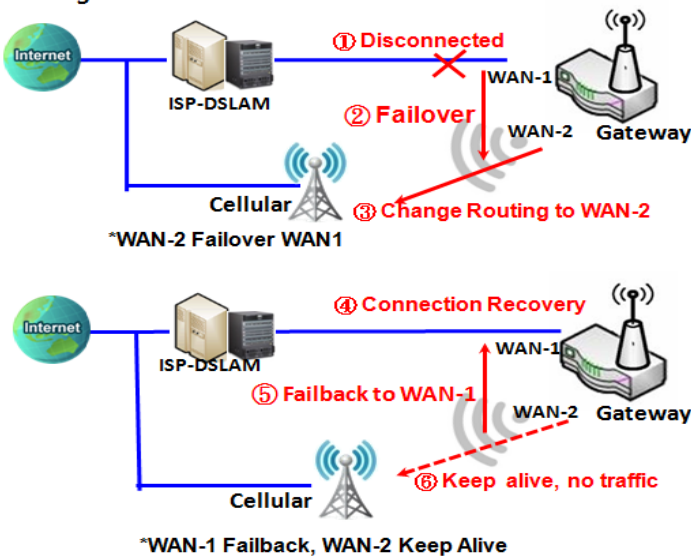

In addition, there is a "Seamless" option for Failover operation mode. When seamless option is activated by checking on the "Seamless" box in configuration window, both the primary connection and the failover connection are started up after system rebooting. But only the primary connection executes the data transfer, while the failover one just keeps alive of connection line. As soon as the primary connection is broken, the system will switch, meaning failover, the routing path to the failover connection to save the dial up time of failover connection since it has been alive.

When the "Seamless" enable checkbox is activated, it can allow the Failover interface to be connected continuously from system booting up. Failover WAN interface just keeps connecting without data traffic. The purpose is to shorten the switch time during failover process. So, when primary connection is disconnected, failover interface will take over the data transfer mission instantly by only changing routing path to the failover interface. The dialing-up time of failover connection is saved since it has been connected beforehand.

## VLAN Tagging

Sometimes, your ISP required a VLAN tag to be inserted into the WAN packets from Router for specific services. Please enable VLAN tagging and specify tag in the WAN physical interface. Please be noted that only Ethernet and ADSL physical interfaces support the feature. For the device with 3G/4G WAN only, it is disabled.

## Physical Interface Setting

Go to **Basic Network > WAN & Uplink > Physical Interface** tab.

The Physical Interface allows user to setup the physical WAN interface and to adjust WAN's behavior.

| Physical Interface List |                    |                |                                     |
|-------------------------|--------------------|----------------|-------------------------------------|
| Interface Name          | Physical Interface | Operation Mode | Action                              |
| WAN-1                   | 3G/4G              | Always on      | <input type="button" value="Edit"/> |
| WAN-2                   | -                  | Disable        | <input type="button" value="Edit"/> |

When **Edit** button is applied, an **Interface Configuration** screen will appear. WAN-1 interface is used in this example.

### Interface Configuration:

| Interface Configuration ( WAN - 1 ) |   |
|-------------------------------------|---|
| Item                                | Setting   |
| ▶ Physical Interface                | 3G/4G   |
| ▶ Operation Mode                    | Always on   |
| ▶ VLAN Tagging                      | <input type="checkbox"/> Enable <input type="text" value="0"/> (1-4095) |

| Interface Configuration   |  |  |
|---------------------------|--|--|
| Item                      | Value setting  | Description  |
| <b>Physical Interface</b> | 1. A Must fill setting<br>2. WAN-1 is the primary interface and is factory set to Always on. | Select one expected interface from the available interface dropdown list. It can be <b>3G/4G</b> , <b>Ethernet</b> or <b>WiFi Module</b> .<br>Depending on the router model, <b>Disable</b> and <b>Failover</b> options will be available only to multiple WAN routers. WAN-2 ~ WAN-4 interfaces are only available to multiple WAN router.  |
| <b>Operation Mode</b>     | A Must fill setting  | Define the operation mode of the interface.<br>Select <b>Always on</b> to make this WAN always active.<br>Select <b>Disable</b> to disable this WAN interface.<br>Select <b>Failover</b> to make this WAN a Failover WAN when the primary or the secondary WAN link failed. Then select the primary or the existed secondary WAN interface to switch Failover from.<br><br>(Note: for WAN-1, only <b>Always on</b> option is available.) |
| <b>VLAN Tagging</b>       | Optional setting   | Check <b>Enable</b> box to enter tag value provided by your ISP. Otherwise uncheck the box.<br><b>Value Range: 1 ~ 4095.</b><br><br>Note: This feature is NOT available for 3G/4G WAN connection.  |

### 2.1.2 Connection Setup

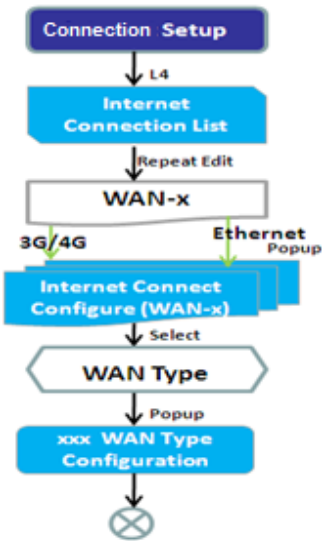

| Physical Interface List |                    |                |                                     |
|-------------------------|--------------------|----------------|-------------------------------------|
| Interface Name          | Physical Interface | Operation Mode | Action                              |
| WAN-1                   | Ethernet           | Always on      | <input type="button" value="Edit"/> |
| WAN-2                   | 3G/4G              | Failover       | <input type="button" value="Edit"/> |

| Internet Connection Configuration ( WAN - 1 ) |              |
|---|--------------|
| Item  | Setting      |
| ▶ WAN Type                                    | Dynamic IP ▾ |

| Dynamic IP WAN Type Configuration |   |
|-----------------------------------|---|
| Item                              | Setting   |
| ▶ Host Name                       | <input type="text"/> (Optional)                                       |
| ▶ ISP Registered MAC Address      | <input type="text"/> <input type="button" value="Clone"/> (Optional)  |
| ▶ MTU Setup                       | <input type="checkbox"/> Enable                                       |
| ▶ NAT                             | <input checked="" type="checkbox"/> Enable                            |
| ▶ IGMP                            | Disable ▾   |
| ▶ WAN IP Alias                    | <input type="checkbox"/> Enable <input type="text" value="10.0.0.1"/> |

After specifying the physical interface for each WAN connection, administrator must configure their connection profile to meet the dial in process of ISP, so that all client hosts in the Intranet of the router can access the Internet.

In "Connection Setup" page, there are some configuration windows: "Internet Connection List", "Internet Connection Configuration", "WAN Type Configuration" and related configuration windows for each WAN type. For the Internet setup of each WAN interface, you must specify its WAN type of physical interface first and then its related parameter configuration for that WAN type.

After clicking on the "Edit" button of a physical interface in "Internet Setup List" window, the "Internet Connection Configuration" window will appear to let you specify which kind of WAN type that you will use for that physical interface to make an Internet connection. Based on your chosen WAN type, you can configure necessary parameters in each corresponding configuration window.

Internet Connection List - Ethernet WAN

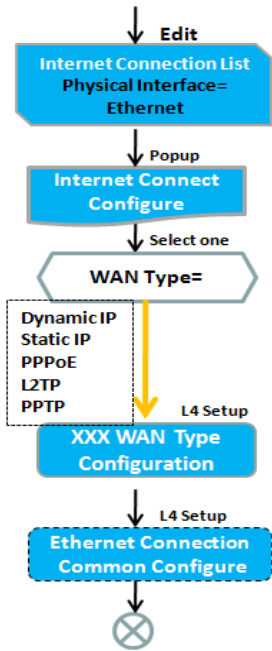

| Internet Connection Configuration ( WAN - 1 ) |   |
|---|---|
| Item  | Setting   |
| ▶ WAN Type                                    | Dynamic IP ▼  |
|   | Static IP   |
|   | Dynamic IP  |
| Dynamic IP WAN Configuration                  |   |
| Item  | Setting   |
| ▶ Host Name                                   | <input type="text"/> (Optional)                                       |
| ▶ ISP Registered MAC Address                  | <input type="text"/> <input type="button" value="Clone"/> (Optional)  |
| ▶ MTU Setup                                   | <input type="checkbox"/> Enable                                       |
| ▶ NAT   | <input checked="" type="checkbox"/> Enable                            |
| ▶ IGMP  | Disable ▼   |
| ▶ WAN IP Alias                                | <input type="checkbox"/> Enable <input type="text" value="10.0.0.1"/> |

**WAN Type for Ethernet Interface:**

Ethernet is the most common WAN and uplink interface for ICR-1601 routers. Usually it is connected with xDSL or cable modem for you to setup the WAN connection. There are various WAN types to connect with ISP:

- **Static IP:** Select this option if ISP provides a fixed IP to you when you subscribe the service. Usually is more expensive but very important for cooperate requirement.
- **Dynamic IP:** The assigned IP address for the WAN by a DHCP server is different every time. It is cheaper and usually for consumer use.
- **PPP over Ethernet:** As known as PPPoE. This WAN type is widely used for ADSL connection. IP is usually different for every dial up.
- **PPTP:** This WAN type is popular in some countries, like Russia.
- **L2TP :** This WAN type is popular in some countries, like Israel.

### Configure Ethernet WAN Setting

| Internet Connection Configuration ( WAN - 1 ) |              |
|---|--------------|
| Item  | Setting      |
| ▶ WAN Type                                    | Dynamic IP ▼ |

When **Edit** button is applied, **Internet Connection Configuration** screen will appear. WAN-1 interface is used in this example.

#### WAN Type = Dynamic IP

When you select it, "Dynamic IP WAN Type Configuration" will appear. Items and setting is explained below.

| Dynamic IP WAN Type Configuration |  |
|-----------------------------------|--|
| Item                              | Setting  |
| ▶ Host Name                       | <input type="text"/> (Optional)                                      |
| ▶ ISP Registered MAC Address      | <input type="text"/> <input type="button" value="Clone"/> (Optional) |

| Dynamic IP WAN Type Configuration |                     |  |
|-----------------------------------|---------------------|--|
| Item                              | Value setting       | Description  |
| Host Name                         | An optional setting | Enter the host name provided by your Service Provider.   |
| ISP Registered MAC Address        | An optional setting | Enter the MAC address that you have registered with your service provider. Or Click the <b>Clone</b> button to clone your PC's MAC to this field. Usually this is the PC's MAC address assigned to allow you to connect to Internet. |

#### WAN Type = Static IP

| Internet Connection Configuration ( WAN - 1 ) |             |
|---|-------------|
| Item  | Setting     |
| ▶ WAN Type                                    | Static IP ▼ |

When you select it, "Static IP WAN Type Configuration" will appear. Items and setting is explained below.

| Static IP WAN Type Configuration |                                 |
|----------------------------------|---------------------------------|
| Item                             | Setting                         |
| ▶ WAN IP Address                 | <input type="text"/>            |
| ▶ WAN Subnet Mask                | 255.255.255.0 (/24) ▼           |
| ▶ WAN Gateway                    | <input type="text"/>            |
| ▶ Primary DNS                    | <input type="text"/>            |
| ▶ Secondary DNS                  | <input type="text"/> (Optional) |

### Static IP WAN Type Configuration

| Item            | Value setting         | Description   |
|-----------------|-----------------------|---|
| WAN IP Address  | A Must filled setting | Enter the WAN IP address given by your Service Provider               |
| WAN Subnet Mask | A Must filled setting | Enter the WAN subnet mask given by your Service Provider              |
| WAN Gateway     | A Must filled setting | Enter the WAN gateway IP address given by your Service Provider       |
| Primary DNS     | A Must filled setting | Enter the primary WAN DNS IP address given by your Service Provider   |
| Secondary DNS   | An optional setting   | Enter the secondary WAN DNS IP address given by your Service Provider |

### WAN Type = PPPoE

| Internet Connection Configuration ( WAN - 1 ) |         |
|---|---------|
| Item  | Setting |
| ▶ WAN Type                                    | PPPoE ▼ |

When you select it, "PPPoE WAN Type Configuration" will appear. Items and setting is explained below.

| PPPoE WAN Type Configuration |                                 |
|------------------------------|---------------------------------|
| Item                         | Setting                         |
| ▶ IP Type                    | IPv4 ▼                          |
| ▶ PPPoE Account              | <input type="text"/>            |
| ▶ PPPoE Password             | <input type="text"/>            |
| ▶ Primary DNS                | <input type="text"/> (Optional) |
| ▶ Secondary DNS              | <input type="text"/> (Optional) |
| ▶ Service Name               | <input type="text"/> (Optional) |
| ▶ Assigned IP Address        | <input type="text"/> (Optional) |



| PPPoE WAN Type Configuration |                       |  |
|------------------------------|-----------------------|--|
| Item                         | Value setting         | Description  |
| PPPoE Account                | A Must filled setting | Enter the PPPoE User Name provided by your Service Provider. |
| PPPoE Password               | A Must filled setting | Enter the PPPoE password provided by your Service Provider.  |
| Primary DNS                  | An optional setting   | Enter the IP address of Primary DNS server.                  |
| Secondary DNS                | An optional setting   | Enter the IP address of Secondary DNS server.                |
| Service Name                 | An optional setting   | Enter the service name if your ISP requires it               |
| Assigned IP Address          | An optional setting   | Enter the IP address assigned by your Service Provider.      |

▣ Internet Connection Configuration ( WAN - 1 )

| Item       | Setting |
|------------|---------|
| ▶ WAN Type | PPTP ▾  |

## WAN Type = PPTP

When you select it, "PPTP WAN Type Configuration" will appear. Items and setting is explained below.

▣ PPTP WAN Type Configuration

| Item                       | Setting                         |
|----------------------------|---------------------------------|
| ▶ IP Mode                  | Dynamic IP Address ▾            |
| ▶ Server IP Address / Name | <input type="text"/>            |
| ▶ PPTP Account             | <input type="text"/>            |
| ▶ PPTP Password            | <input type="text"/>            |
| ▶ Connection ID            | <input type="text"/> (Optional) |
| ▶ MPPE                     | <input type="checkbox"/> Enable |

| PPTP WAN Type Configuration |                       |  |
|-----------------------------|-----------------------|--|
| Item                        | Value setting         | Description  |
| IP Mode                     | A Must filled setting | Select either Static or Dynamic IP address for PPTP Internet connection. <ul style="list-style-type: none"> <li>● When <b>Static IP Address</b> is selected, you will need to enter the <b>WAN IP Address, WAN Subnet Mask, and WAN Gateway</b>.                             <ul style="list-style-type: none"> <li>■ <b>WAN IP Address</b> (A Must filled setting): Enter the WAN IP address given by your Service Provider.</li> <li>■ <b>WAN Subnet Mask</b> (A Must filled setting): Enter the WAN subnet mask given by your Service Provider.</li> <li>■ <b>WAN Gateway</b> (A Must filled setting): Enter the WAN gateway IP address given by your Service Provider.</li> </ul> </li> <li>● When <b>Dynamic IP</b> is selected, there are no above settings required.</li> </ul> |
| Server IP Address/Name      | A Must filled setting | Enter the PPTP server name or IP Address.  |
| PPTP Account                | A Must filled setting | Enter the PPTP username provided by your Service Provider.   |
| PPTP Password               | A Must filled setting | Enter the PPTP connection password provided by your Service Provider.  |

|                      |                     |   |
|----------------------|---------------------|---|
| <b>Connection ID</b> | An optional setting | Enter a name to identify the PPTP connection.   |
| <b>MPPE</b>          | An optional setting | Select <b>Enable</b> to enable MPPE (Microsoft Point-to-Point Encryption) security for PPTP connection. |

## WAN Type = L2TP

| Internet Connection Configuration ( WAN - 1 ) |         |
|---|---------|
| Item  | Setting |
| ▶ WAN Type                                    | L2TP ▼  |

When you select it, "L2TP WAN Type Configuration" will appear. Items and setting is explained below.

| L2TP WAN Type Configuration |  |
|-----------------------------|--|
| Item                        | Setting  |
| ▶ IP Mode                   | Dynamic IP Address ▼                             |
| ▶ Server IP Address / Name  | <input type="text"/>                             |
| ▶ L2TP Account              | <input type="text"/>                             |
| ▶ L2TP Password             | <input type="text"/>                             |
| ▶ Service Port              | User-defined ▼ <input type="text" value="1702"/> |
| ▶ MPPE                      | <input type="checkbox"/> Enable                  |

| L2TP WAN Type Configuration   |                       |  |
|-------------------------------|-----------------------|--|
| Item                          | Value setting         | Description  |
| <b>IP Mode</b>                | A Must filled setting | Select either Static or Dynamic IP address for L2TP Internet connection. <ul style="list-style-type: none"> <li>● When <b>Static IP Address</b> is selected, you will need to enter the <b>WAN IP Address, WAN Subnet Mask, and WAN Gateway</b>. <ul style="list-style-type: none"> <li>■ <b>WAN IP Address</b> (A Must filled setting): Enter the WAN IP address given by your Service Provider.</li> <li>■ <b>WAN Subnet Mask</b> (A Must filled setting): Enter the WAN subnet mask given by your Service Provider.</li> <li>■ <b>WAN Gateway</b> (A Must filled setting): Enter the WAN gateway IP address given by your Service Provider.</li> </ul> </li> <li>● When <b>Dynamic IP</b> is selected, there are no above settings required.</li> </ul> |
| <b>Server IP Address/Name</b> | A Must filled setting | Enter the L2TP server name or IP Address.  |
| <b>L2TP Account</b>           | A Must filled setting | Enter the L2TP username provided by your Service Provider.   |
| <b>L2TP Password</b>          | A Must filled setting | Enter the L2TP connection password provided by your Service Provider.  |

|              |                       |  |
|--------------|-----------------------|--|
| Service Port | A Must filled setting | Enter the service port that the Internet service.<br>There are three options can be selected : <ul style="list-style-type: none"> <li>● <b>Auto:</b> Port will be automatically assigned.</li> <li>● <b>1701 (For Cisco):</b> Set service port to port 1701 to connect to CISCO server.</li> <li>● <b>User-defined:</b> enter a service port provided by your Service Provider.</li> </ul> |
| MPPE         | An optional setting   | Select <b>Enable</b> to enable MPPE (Microsoft Point-to-Point Encryption) security for PPTP connection.  |

## Ethernet Connection Common Configuration

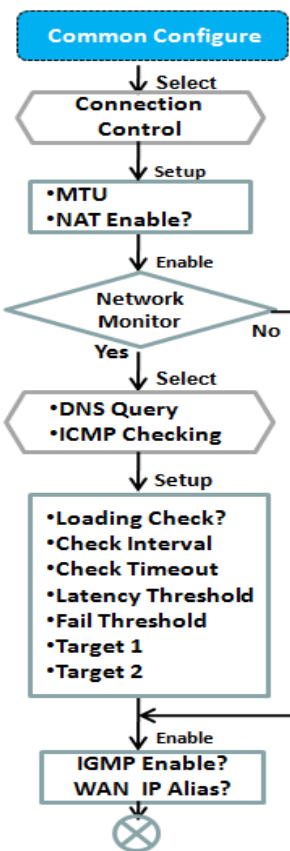

|                |  |
|----------------|--|
| ▶ MTU Setup    | <input type="checkbox"/> Enable            |
| ▶ NAT          | <input checked="" type="checkbox"/> Enable |
| ▶ IGMP         | Disable ▾                                  |
| ▶ WAN IP Alias | <input type="checkbox"/> Enable 10.0.0.1   |

| Network Monitoring Configuration   |  |
|------------------------------------|--|
| Item                               | Setting                                    |
| ▶ Network Monitoring Configuration | <input checked="" type="checkbox"/> Enable |
| ▶ Checking Method                  | DNS Query ▾                                |
| ▶ Loading Check                    | <input checked="" type="checkbox"/> Enable |
| ▶ Query Interval                   | 5 (seconds)                                |
| ▶ Latency Threshold                | 3000 (ms)                                  |
| ▶ Fail Threshold                   | 5 (Times)                                  |
| ▶ Target1                          | DNS1 ▾                                     |
| ▶ Target2                          | None ▾                                     |

There are some important parameters to be set up no matter which Ethernet WAN type is selected. You should follow up the rule to configure.

## Connection Control

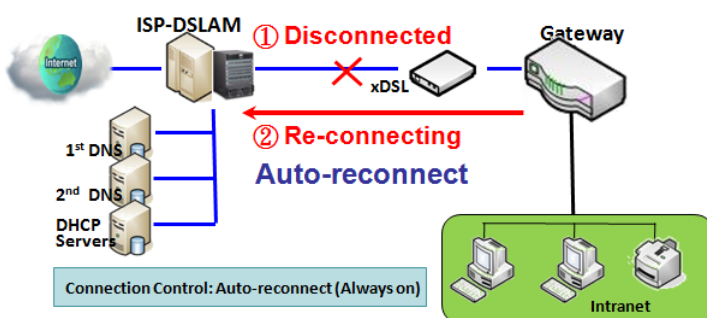

**Auto-reconnect:** This gateway will establish Internet connection automatically once it has been booted up, and try to reconnect once the connection is down. It's recommended to choose this scheme if for mission critical applications to ensure full-time Internet connection.

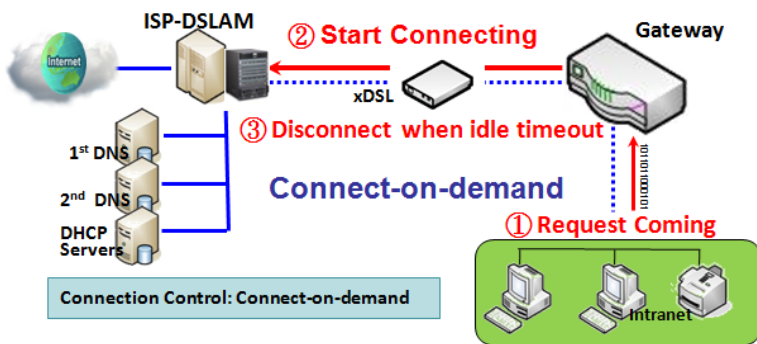

**Connect-on-demand:** This gateway won't start to establish Internet connection until local data is going to be sent to WAN side. After normal data transferring between LAN and WAN sides, this gateway will disconnect WAN connection if idle time reaches value of Maximum Idle Time.

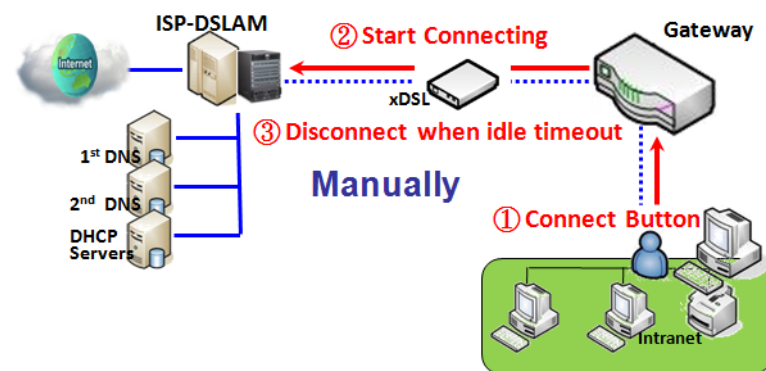

**Manually:** This gateway won't start to establish WAN connection until you press "Connect" button on web UI. After normal data transferring between LAN and WAN sides, this gateway will disconnect WAN connection if idle time reaches value of Maximum Idle Time.

Please be noted, if the WAN interface serves as the primary one for another WAN interface in Failover role, the Connection Control parameter will not be available to you to configure as the system must set it to "Auto-reconnect (Always on)".

**Network Monitoring**

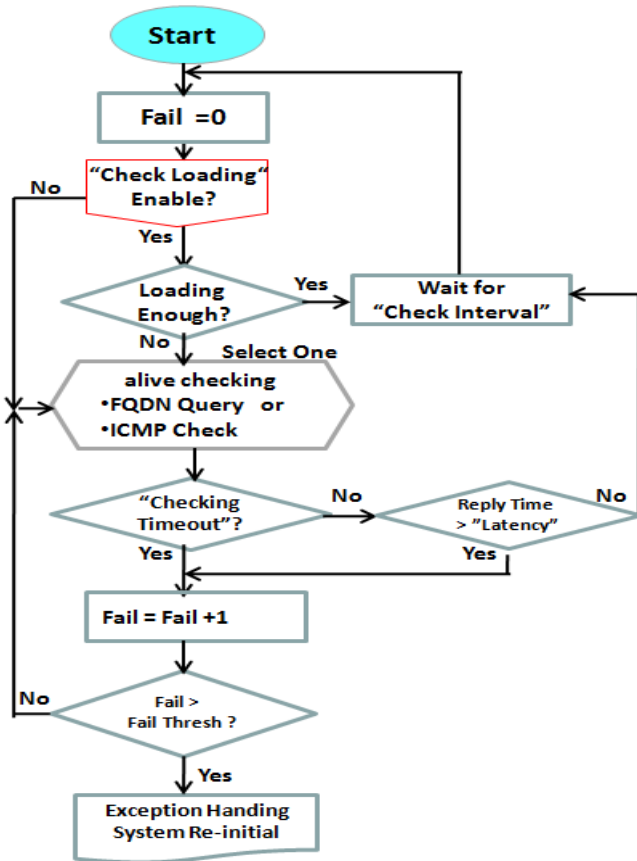

It is necessary to monitor connection status continuous. To do it, "ICMP Check" and "FQDN Query" are used to check. When there is traffic of connection, checking packet will waste bandwidth. Response time of replied packets may also increase. To avoid "Network Monitoring" work abnormally, enabling "Checking Loading" option will stop connection check when there is traffic. It will wait for another "Check Interval" and then check loading again. When you do "Network Monitoring", if reply time longer than "Latency" or even no response longer than "Checking Timeout", "Fail" count will be increased. If it is continuous and "Fail" count is more than "Fail Threshold", gateway will do exception handing process and re-initial this connection again. Otherwise, network monitoring process will be start again.

**Set up "Ethernet Common Configuration"**

| Ethernet WAN Common Configuration |  |  |
|-----------------------------------|--|--|
| Item                              | Value setting  | Description  |
| Connection Control                | A Must filled setting  | There are three connection modes. <ul style="list-style-type: none"> <li>• <b>Auto-reconnect</b> enables the router to always keep the Internet connection on.</li> <li>• <b>Connect-on-demand</b> enables the router to automatically re-establish Internet connection as soon as user attempts to access the Internet. Internet connection will be disconnected when it has been inactive for a specified idle time.</li> <li>• <b>Connect Manually</b> allows user to connect to Internet manually. Internet connection will be inactive after it has been inactive for specified idle time.</li> </ul> |
| Maximum Idle Time                 | 1. An Optional setting<br>2. By default 600 seconds is filled-in | Specify the maximum Idle time setting to disconnect the internet connection when the connection idle timed out.<br><b>Value Range:</b> 300 ~ 86400.<br><b>Note:</b> This field is available only when <b>Connect-on-demand</b> or <b>Connect Manually</b> is selected as the connection control scheme.  |

|                           |  |  |
|---------------------------|--|--|
| <b>MTU Setup</b>          | <ol style="list-style-type: none"> <li>1. An Optional setting</li> <li>2. <b>Uncheck</b> by default</li> </ol>   | <p>Check the Enable box to enable the MTU (Maximum Transmission Unit) limit, and specify the <b>MTU</b> for the 3G/4G connection.</p> <p><b>MTU</b> refers to Maximum Transmission Unit. It specifies the largest packet size permitted for Internet transmission.</p> <p><b>Value Range: 1200 ~ 1500.</b></p>   |
| <b>MTU Setup</b>          | <ol style="list-style-type: none"> <li>1. A Must filled setting</li> <li>2. <b>Auto</b> (value zero) is set by default</li> <li>3. Manual set range 1200~1500</li> </ol> | <p><b>MTU</b> refers to Maximum Transmission Unit. It specifies the largest packet size permitted for Internet transmission.</p> <p>When set to <b>Auto</b> (value '0'), the router selects the best MTU for best Internet connection performance.</p>   |
| <b>NAT</b>                | <ol style="list-style-type: none"> <li>1. An optional setting</li> <li>2. NAT is enabled by default</li> </ol>   | <p>Enable NAT to apply NAT on the WAN connection. Uncheck the box to disable NAT function.</p>   |
| <b>Network Monitoring</b> | <ol style="list-style-type: none"> <li>1. An optional setting</li> <li>2. Enabled by default</li> </ol>  | <p>When the Network Monitoring feature is enabled, the gateway will use DNS Query or ICMP to periodically check Internet connection –connected or disconnected.</p> <ul style="list-style-type: none"> <li>● Choose either <b>DNS Query</b> or <b>ICMP Checking</b> to detect WAN link. With <b>DNS Query</b>, the system checks the connection by sending DNS Query packets to the destination specified in Target 1 and Target 2. With <b>ICMP Checking</b>, the system will check connection by sending ICMP request packets to the destination specified in Target 1 and Target 2.</li> <li>● <b>Loading Check</b><br/>Enable Loading Check allows the router to ignore unreturned DNS Queries or ICMP requests when WAN bandwidth is fully occupied. This is to prevent false link-down status.</li> <li>● <b>Check Interval</b> defines the transmitting interval between two DNS Query or ICMP checking packets.</li> <li>● <b>Check Timeout</b> defines the timeout of each DNS query/ICMP.</li> <li>● <b>Latency Threshold</b> defines the tolerance threshold of responding time.</li> <li>● <b>Fail Threshold</b> specifies the detected disconnection before the router recognize the WAN link down status. Enter a number of detecting disconnection times to be the threshold before disconnection is acknowledged.</li> <li>● <b>Target1 (DNS1 set by default)</b> specifies the first target of sending DNS query/ICMP request. <ul style="list-style-type: none"> <li>■ <b>DNS1</b>: set the primary DNS to be the target.</li> <li>■ <b>DNS2</b>: set the secondary DNS to be the target.</li> <li>■ <b>Gateway</b>: set the Current gateway to be the target.</li> <li>■ <b>Other Host</b>: enter an IP address to be the target.</li> </ul> </li> <li>● <b>Target2 (None set by default)</b> specifies the second target of sending DNS query/ICMP request. <ul style="list-style-type: none"> <li>■ <b>None</b>: to disable <b>Target2</b>.</li> <li>■ <b>DNS1</b>: set the primary DNS to be the target.</li> <li>■ <b>DNS2</b>: set the secondary DNS to be the target.</li> <li>■ <b>Gateway</b>: set the Current gateway to be the target.</li> <li>■ <b>Other Host</b>: enter an IP address to be the target.</li> </ul> </li> </ul> |
| <b>IGMP</b>               | <ol style="list-style-type: none"> <li>1. A Must filled setting</li> <li>2. Disable is set by default</li> </ol>   | <p>Enable IGMP (Internet Group Management Protocol) would enable the router to listen to IGMP packets to discover which interfaces are connected to which device. The router uses the interface information generated by IGMP to reduce bandwidth consumption in a multi-access network environment to avoid flooding the entire network.</p>  |

|              |  |  |
|--------------|--|--|
| WAN IP Alias | 1. An optional setting<br>2. <b>Unchecked</b> by default | Enable <b>WAN IP Alias</b> then enter the IP address provided by your service provider.<br><b>WAN IP Alias</b> is used by the device router and is treated as a second set of WAN IP to provide dual WAN IP address to your LAN network. |
| Save         | N/A  | Click <b>Save</b> to save the settings.  |
| Undo         | N/A  | Click <b>Undo</b> to cancel the settings.  |

## Internet Connection – 3G/4G WAN

```

graph TD
    A[Internet Connect List Physical Interface= 3G/4G] -- Popup --> B[Internet Connect Configure]
    B -- Select --> C{WAN Type= 3G/4G}
    C -- Popup --> D[3G/4G WAN Type Configuration]
    D -- L4 Setup --> E[Configure SIM-A/ SIM-B]
    E -- L4 Setup --> F[SIM-A/ SIM-B APN Profile List]
    F -- Repeat Add/Edit --> G[APN Profile-x]
    G -- Popup --> H[SIM-A/B APN Profile Configuration]
    H -- L4 Setup --> I[3G/4G Connection Common Configure]
    
```

| Internet Connection Configuration ( WAN - 2 ) |   |
|---|---|
| Item  | Setting   |
| ▶ WAN Type                                    | 3G/4G ▼   |
| 3G/4G WAN Type Configuration                  |   |
| Item  | Setting   |
| ▶ Preferred SIM Card                          | SIM-A First ▼ Failback : <input type="checkbox"/> Enable              |
| ▶ Auto Flight Mode                            | <input type="checkbox"/> Enable                                       |
| Connection with SIM-A Card                    |   |
| Item  | Setting   |
| ▶ Network Type                                | Auto ▼  |
| 3G/4G Connection Common Configuration         |   |
| Item  | Setting   |
| ▶ Time Schedule                               | (0) Always ▼  |
| ▶ MTU Setup                                   | <input type="checkbox"/> Enable                                       |
| ▶ IP Passthrough (Cellular Bridge)            | <input type="checkbox"/> Enable Fixed MAC : <input type="text"/>      |
| ▶ NAT   | <input checked="" type="checkbox"/> Enable                            |
| ▶ WAN IP Alias                                | <input type="checkbox"/> Enable <input type="text" value="10.0.0.1"/> |

### Preferred SIM Card – Dual SIM Fail Over

For 3G/4G embedded device, one embedded cellular module can create only one WAN interface. This device has featured by using dual SIM cards for one module with special fail-over mechanism. It is called Dual SIM Failover. This feature is useful for ISP switch over when location is changed. Within “Dual SIM Failover”, there are various usage scenarios, including "SIM-A First", "SIM-B First“ with “Failback” enabled or not, and “SIM-A Only and “SIM-B Only”.

#### SIM-A/SIM-B only

When “SIM-A Only” or “SIM-B Only” is used, the specified SIM slot card is the only one to be used for negotiation parameters between gateway device and cellular ISP.

**SIM-A / SIM-B first without enable Failback**

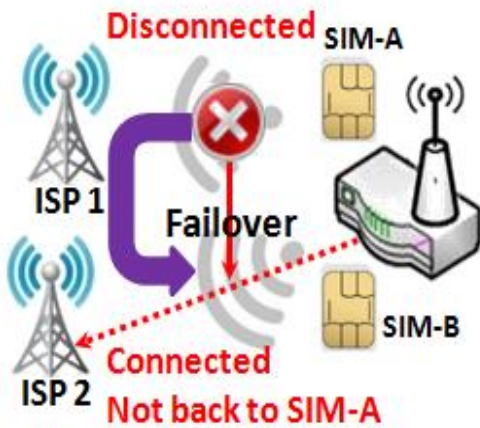

By default, “SIM-A First” scenario is used to connect to cellular ISP for data transfer. In the case of “SIM-A First” or “SIM-B First” scenario, the gateway will try to connect to the Internet by using SIM-A or SIM-B card first. And when the connection is broken, the gateway will switch to use the other SIM card for an alternate automatically and **will not switch back** to use original SIM card except current SIM connection is also broken. That is, SIM-A and SIM-B are used iteratively, but either one will keep being used for data transfer when current connection is still alive.

**SIM-A / SIM-B first with Failback enable**

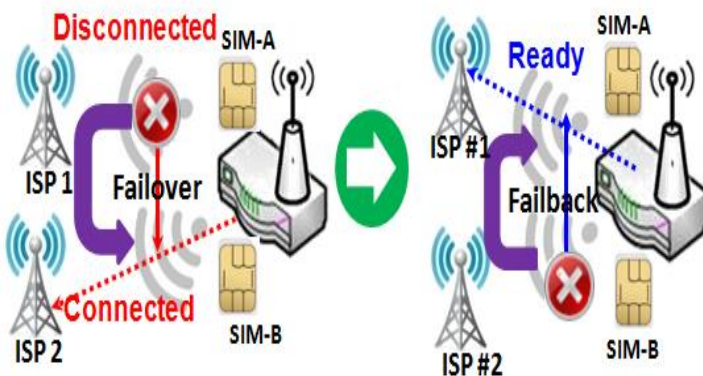

With Failback option enabled, “SIM-A First” scenario is used to connect when the connection is broken, gateway system will switch to use SIM-B. And when SIM-A connection is recovered, it will switch back to use original SIM-A card

**Configure 3G/4G WAN Setting**

When **Edit** button is applied, **Internet Connection Configuration**, and **3G/4G WAN Configuration** screens will appear.

| Internet Connection Configuration ( WAN - 1 ) |  |
|---|--|
| Item  | Setting  |
| ▶ WAN Type                                    | 3G/4G ▼  |
| 3G/4G WAN Type Configuration                  |  |
| Item  | Setting  |
| ▶ Preferred SIM Card                          | SIM-A First ▼ Failback : <input type="checkbox"/> Enable |
| ▶ Auto Flight Mode                            | <input type="checkbox"/> Enable                          |



| 3G/4G Connection Configuration |  |   |
|--------------------------------|--|---|
| Item                           | Value setting  | Description   |
| WAN Type                       | <ol style="list-style-type: none"> <li>1. A Must filled setting</li> <li>2. <b>3G/4G</b> is set by default.</li> </ol>   | From the dropdown box, select Internet connection method for 3G/4G WAN Connection. Only <b>3G/4G</b> is available.  |
| Preferred SIM Card             | <ol style="list-style-type: none"> <li>1. A Must filled setting</li> <li>2. By default <b>SIM-A First</b> is selected</li> <li>3. <b>Failback</b> is unchecked by default</li> </ol> | <p>Choose which SIM card you want to use for the connection.</p> <p>When <b>SIM-A First</b> or <b>SIM-B First</b> is selected, it means the connection is built first by using SIM A/SIM B. And if the connection is failed, it will change to the other SIM card and try to dial again, until the connection is up.</p> <p>When <b>SIM-A only</b> or <b>SIM-B only</b> is selected, it will try to dial up only using the SIM card you selected.</p> <p>When <b>Failback</b> is checked, it means if the connection is dialed-up not using the main SIM you selected, it will failback to the main SIM and try to establish the connection periodically.</p> <p><b>Note_1:</b> For the product with single SIM design, only <b>SIM-A Only</b> option is available.</p> <p><b>Note_2:</b> <b>Failback</b> is available only when <b>SIM-A First</b> or <b>SIM-B First</b> is selected.</p>  |
| Auto Flight Mode               | The box is unchecked by default  | <p>Check the <b>Enable</b> box to activate the function.</p> <p>By default, if you disabled the <b>Auto Flight Mode</b>, the cellular module will always occupy a physical channel with cellular tower. It can get data connection instantly, and receive managing SMS all the time on required. If you enabled the <b>Auto Flight Mode</b>, the gateway will pop up a message <i>"Flight mode will cause cellular function to be malfunctioned, when the data session is offline."</i>, and it will make the cellular module into flight mode and disconnected with cellular tower physically. In addition, whenever the cellular module is going to be used for data connection to backup the failed primary connection, the cellular module will be active to connect with cellular tower and get the data connection for use, It takes few more seconds.</p> <p><b>Note:</b> Keep it unchecked unless your cellular ISP asked the connected gateway to enable the Auto Flight Mode.</p> |

## Configure SIM-A / SIM-B Card

Here you can set configurations for the cellular connection according to your situation or requirement.

| Connection with SIM-A Card |                                 |
|----------------------------|---------------------------------|
| Item                       | Setting                         |
| ▶ Network Type             | Auto ▾                          |
| ▶ Dial-Up Profile          | Manual-configuration ▾          |
| ▶ APN                      | gprsa.agnep                     |
| ▶ IP Type                  | IPv4 ▾                          |
| ▶ PIN Code                 | <input type="text"/> (Optional) |
| ▶ Dial Number              | <input type="text"/> (Optional) |
| ▶ Account                  | <input type="text"/> (Optional) |
| ▶ Password                 | <input type="text"/> (Optional) |
| ▶ Authentication           | Auto ▾                          |
| ▶ IP Mode                  | Dynamic IP ▾                    |
| ▶ Primary DNS              | <input type="text"/> (Optional) |
| ▶ Secondary DNS            | <input type="text"/> (Optional) |
| ▶ Roaming                  | <input type="checkbox"/> Enable |

**Note\_1:** Configurations of SIM-B Card follows the same rule of Configurations of SIM-A Card, here we list SIM-A as the example.

**Note\_2:** Both **Connection with SIM-A Card** and **Connection with SIM-B Card** will pop up only when the **SIM-A First** or **SIM-B First** is selected, otherwise it only pops out one of them.

| Connection with SIM-A/-B Card |   |  |
|-------------------------------|---|--|
| Item                          | Value setting   | Description  |
| Network Type                  | 1. A Must filled setting<br>2. By default <b>Auto</b> is selected | Select <b>Auto</b> to register a network automatically, regardless of the network type.<br>Select <b>2G Only</b> to register the 2G network only.<br>Select <b>2G Prefer</b> to register the 2G network first if it is available.<br>Select <b>3G only</b> to register the 3G network only.<br>Select <b>3G Prefer</b> to register the 3G network first if it is available.<br>Select <b>LTE only</b> to register the LTE network only.<br><br><b>Note:</b> Options may be different due to the specification of the module. |

|                                       |   |  |
|---------------------------------------|---|--|
| <b>Dial-Up Profile</b>                | <ol style="list-style-type: none"> <li>1. A Must filled setting</li> <li>2. By default <b>Manual-configuration</b> is selected</li> </ol> | <p>Specify the type of dial-up profile for your 3G/4G network. It can be <b>Manual-configuration</b>, <b>APN Profile List</b>, or <b>Auto-detection</b>.</p> <p>Select <b>Manual-configuration</b> to set <b>APN</b> (Access Point Name), <b>Dial Number</b>, <b>Account</b>, and <b>Password</b> to what your carrier provides. Select <b>APN Profile List</b> to set more than one profile to dial up in turn, until the connection is established. It will pop up a new filed, please go to <b>Basic Network &gt; WAN &amp; Uplink &gt; Internet Setup &gt; SIM-A APN Profile List</b> for details.</p> <p>Select <b>Auto-detection</b> to automatically bring out all configurations needed while dialing-up, by comparing the IMSI of the SIM card to the record listed in the manufacturer’s database.</p> <p><b>Note_1:</b> You are highly recommended to select the <b>Manual</b> or <b>APN Profile List</b> to specify the network for your subscription. Your ISP always provides such network settings for the subscribers.</p> <p><b>Note_2:</b> If you select <b>Auto-detection</b>, it is likely to connect to improper network, or failed to find a valid APN for your ISP.</p> |
| <b>APN</b>                            | <ol style="list-style-type: none"> <li>1. A Must filled setting</li> <li>2. String format : any text</li> </ol>                           | <p>Enter the <b>APN</b> you want to use to establish the connection. This is a must-filled setting if you selected <b>Manual-configuration</b> as dial-up profile scheme.</p>  |
| <b>IP Type</b>                        | <ol style="list-style-type: none"> <li>1. A Must filled setting</li> <li>2. By default <b>IPv4</b> is selected</li> </ol>                 | <p>Specify the IP type of the network service provided by your 3G/4G network. It can be <b>IPv4</b>, <b>IPv6</b>, or <b>IPv4/6</b>.</p>  |
| <b>PIN code</b>                       | <ol style="list-style-type: none"> <li>1. An Optional setting</li> <li>2. String format : integer</li> </ol>                              | <p>Enter the PIN (Personal Identification Number) code if it needs to unlock your SIM card.</p>  |
| <b>Dial Number, Account, Password</b> | <ol style="list-style-type: none"> <li>1. An Optional setting</li> <li>2. String format : any text</li> </ol>                             | <p>Enter the optional <b>Dial Number</b>, <b>Account</b>, and <b>Password</b> settings if your ISP provided such settings to you.</p> <p>Note: These settings are only displayed when Manual-configuration is selected.</p>  |
| <b>Authentication</b>                 | <ol style="list-style-type: none"> <li>1. A Must filled setting</li> <li>2. By default <b>Auto</b> is selected</li> </ol>                 | <p>Select <b>PAP</b> (Password Authentication Protocol) and use such protocol to be authenticated with the carrier’s server.</p> <p>Select <b>CHAP</b> (Challenge Handshake Authentication Protocol) and use such protocol to be authenticated with the carrier’s server.</p> <p>When <b>Auto</b> is selected, it means it will authenticate with the server either <b>PAP</b> or <b>CHAP</b>.</p>   |
| <b>IP Mode</b>                        | <ol style="list-style-type: none"> <li>1. A Must filled setting</li> <li>2. By default <b>Dynamic IP</b> is selected</li> </ol>           | <p>When <b>Dynamic IP</b> is selected, it means it will get all IP configurations from the carrier’s server and set to the device directly.</p> <p>If you have specific application provided by the carrier, and want to set IP configurations on your own, you can switch to <b>Static IP</b> mode and fill in all parameters that required, such as IP address, subnet mask and gateway.</p> <p><b>Note:</b> <b>IP Subnet Mask</b> is a must filled setting, and make sure you have the right configuration. Otherwise, the connection may get issues.</p>   |
| <b>Primary DNS</b>                    | <ol style="list-style-type: none"> <li>1. An Optional setting</li> <li>2. String format : IP address (IPv4 type)</li> </ol>               | <p>Enter the IP address to change the primary DNS (Domain Name Server) setting. If it is not filled-in, the server address is given by the carrier while dialing-up.</p>   |
| <b>Secondary DNS</b>                  | <ol style="list-style-type: none"> <li>1. An Optional setting</li> <li>2. String format : IP address (IPv4 type)</li> </ol>               | <p>Enter the IP address to change the secondary DNS (Domain Name Server) setting. If it is not filled-in, the server address is given by the carrier while dialing-up.</p>   |

|                |                                 |  |
|----------------|---------------------------------|--|
| <b>Roaming</b> | The box is unchecked by default | Check the box to establish the connection even the registration status is roaming, not in home network.<br><br><b>Note:</b> It may cost additional charges if the connection is under roaming. |
|----------------|---------------------------------|--|

## Create/Edit SIM-A / SIM-B APN Profile List

You can add a new APN profile for the connection, or modify the content of the APN profile you added. It is available only when you select **Dial-Up Profile** as **APN Profile List**.

| SIM-A APN Profile List <input type="button" value="Add"/> <input type="button" value="Delete"/> |              |     |         |         |          |                |          |        |         |
|---|--------------|-----|---------|---------|----------|----------------|----------|--------|---------|
| ID  | Profile Name | APN | IP Type | Account | Password | Authentication | Priority | Enable | Actions |

List all the APN profile you created, easily for you to check and modify. It is available only when you select **Dial-Up Profile** as **APN Profile List**. When **Add** button is applied, an **APN Profile Configuration** screen will appear.

| SIM-A APN Profile Configuration |  |
|---------------------------------|--|
| Item                            | Setting                                |
| ▶ Profile Name                  | <input type="text" value="Profile-1"/> |
| ▶ APN                           | <input type="text"/>                   |
| ▶ IP Type                       | <input type="text" value="IPv4"/> ▼    |
| ▶ Account                       | <input type="text"/> (Optional)        |
| ▶ Password                      | <input type="text"/> (Optional)        |
| ▶ Authentication                | <input type="text" value="Auto"/> ▼    |
| ▶ Priority                      | <input type="text"/>                   |
| ▶ Profile                       | <input type="checkbox"/> Enable        |

| SIM-A/-B APN Profile Configuration |   |   |
|------------------------------------|---|---|
| Item                               | Value setting   | Description   |
| <b>Profile Name</b>                | 1. By default <b>Profile-x</b> is listed<br>2. String format : any text | Enter the profile name you want to describe for this profile.   |
| <b>APN</b>                         | String format : any text  | Enter the <b>APN</b> you want to use to establish the connection.   |
| <b>IP Type</b>                     | 1. A Must filled setting<br>2. By default <b>IPv4</b> is selected       | Specify the IP type of the network service provided by your 3G/4G network. It can be <b>IPv4</b> , <b>IPv6</b> , or <b>IPv4/6</b> . |
| <b>Account</b>                     | String format : any text  | Enter the <b>Account</b> you want to use for the authentication.<br><b>Value Range:</b> 0 ~ 53 characters.                          |
| <b>Password</b>                    | String format : any text  | Enter the <b>Password</b> you want to use for the authentication.   |

|                       |   |   |
|-----------------------|---|---|
| <b>Authentication</b> | 1. A Must filled setting<br>2. By default <b>Auto</b> is selected | Select the Authentication method for the 3G/4G connection. It can be <b>Auto</b> , <b>PAP</b> , <b>CHAP</b> , or <b>None</b> .  |
| <b>Priority</b>       | 1. A Must filled setting<br>2. String format : integer            | Enter the value for the dialing-up order. The valid value is from 1 to 16. It will start to dial up with the profile that assigned with the smallest number.<br><b>Value Range: 1 ~ 16.</b> |
| <b>Profile</b>        | The box is checked by default                                     | Check the box to enable this profile.<br>Uncheck the box to disable this profile in dialing-up action.  |
| <b>Save</b>           | N/A   | Click the <b>Save</b> button to save the configuration.   |
| <b>Undo</b>           | N/A   | Click the <b>Undo</b> button to restore what you just configured back to the previous setting.  |
| <b>Back</b>           | N/A   | When the <b>Back</b> button is clicked, the screen will return to the previous page.  |

## Setup 3G/4G Connection Common Configuration

Here you can change common configurations for 3G/4G WAN.

| 3G/4G Connection Common Configuration |   |
|---------------------------------------|---|
| Item                                  | Setting   |
| ▶ Time Schedule                       | (0) Always ▾  |
| ▶ MTU Setup                           | <input type="checkbox"/> Enable                                       |
| ▶ IP Passthrough (Cellular Bridge)    | <input type="checkbox"/> Enable Fixed MAC : <input type="text"/>      |
| ▶ NAT                                 | <input checked="" type="checkbox"/> Enable                            |
| ▶ IGMP                                | Disable ▾   |
| ▶ WAN IP Alias                        | <input type="checkbox"/> Enable <input type="text" value="10.0.0.1"/> |

| 3G/4G Connection Common Configuration |   |   |
|---------------------------------------|---|---|
| Item                                  | Value setting   | Description   |
| <b>Connection Control</b>             | By default <b>Auto-reconnect</b> is selected                            | When <b>Auto-reconnect</b> is selected, it means it will try to keep the Internet connection on all the time whenever the physical link is connected.<br>When <b>Connect-on-demand</b> is selected, it means the Internet connection will be established only when detecting data traffic.<br>When <b>Connect Manually</b> is selected, it means you need to click the <b>Connect</b> button to dial up the connection manually. Please go to <b>Status &gt; Basic Network &gt; WAN &amp; Uplink</b> tab for details.<br><br><b>Note:</b> If the WAN interface serves as the primary one for another WAN interface in Failover role( and vice versa), the Connection Control parameter will not be available on both WANs as the system must set it to "Auto-reconnect" |
| <b>Maximum Idle Time</b>              | 1. An Optional setting<br>2. By default <b>600</b> seconds is filled-in | Specify the maximum Idle time setting to disconnect the internet connection when the connection idle timed out.<br><b>Value Range: 300 ~ 86400.</b>   |

|  |   |   |
|--|---|---|
|  |   | <b>Note:</b> This field is available only when <b>Connect-on-demand</b> or <b>Connect Manually</b> is selected as the connection control scheme.  |
| <b>Time Schedule</b>                     | 1. A Must filled setting<br>2. By default <b>(0) Always</b> is selected   | When <b>(0) Always</b> is selected, it means this WAN is under operation all the time. Once you have set other schedule rules, there will be other options to select. Please go to <b>Object Definition &gt; Scheduling</b> for details.  |
| <b>MTU Setup</b>                         | 1. An Optional setting<br>2. <b>Uncheck</b> by default  | Check the <b>Enable</b> box to enable the MTU (Maximum Transmission Unit) limit, and specify the <b>MTU</b> for the 3G/4G connection.<br><b>MTU</b> refers to Maximum Transmission Unit. It specifies the largest packet size permitted for Internet transmission.<br><b>Value Range:</b> 1200 ~ 1500.  |
| <b>IP Pass-through (Cellular Bridge)</b> | 1. The box is unchecked by default<br>2. String format for <b>Fixed MAC</b> :<br>MAC address, e.g.<br>00:50:18:aa:bb:cc | When <b>Enable</b> box is checked, it means the device will directly assign the WAN IP to the first connected local LAN client.<br>However, when an optional <b>Fixed MAC</b> is filled-in a non-zero value, it means only the client with this MAC address can get the WAN IP address.<br><br><b>Note:</b> When the <b>IP Pass-through</b> is on, <b>NAT</b> and <b>WAN IP Alias</b> will be unavailable until the function is disabled again. |
| <b>NAT</b>                               | <b>Check</b> by default   | Uncheck the box to disable <b>NAT</b> (Network Address Translation) function.   |
| <b>IGMP</b>                              | By default <b>Disable</b> is selected   | Select <b>Auto</b> to enable <b>IGMP</b> function.<br>Check the <b>Enable</b> box to enable <b>IGMP Proxy</b> .   |
| <b>WAN IP Alias</b>                      | 1. Unchecked by default<br>2. String format: IP address (IPv4 type)   | Check the box to enable <b>WAN IP Alias</b> , and fill in the IP address you want to assign.  |

| Network Monitoring Configuration   |  |
|------------------------------------|--|
| Item                               | Setting                                    |
| ▶ Network Monitoring Configuration | <input checked="" type="checkbox"/> Enable |
| ▶ Checking Method                  | DNS Query ▼                                |
| ▶ Loading Check                    | <input checked="" type="checkbox"/> Enable |
| ▶ Query Interval                   | 5 (seconds)                                |
| ▶ Latency Threshold                | 3000 (ms)                                  |
| ▶ Fail Threshold                   | 5 (Times)                                  |
| ▶ Target1                          | DNS1 ▼                                     |
| ▶ Target2                          | None ▼                                     |

| Network Monitoring Configuration |   |   |
|----------------------------------|---|---|
| Item                             | Value setting   | Description   |
| Network Monitoring Configuration | 1. An optional setting<br>2. Box is checked by default                  | Check the <b>Enable</b> box to activate the network monitoring function.  |
| Checking Method                  | 1. An Optional setting<br>2. <b>DNS Query</b> is set by default         | Choose either <b>DNS Query</b> or <b>ICMP Checking</b> to detect WAN link. With <b>DNS Query</b> , the system checks the connection by sending DNS Query packets to the destination specified in Target 1 and Target 2. With <b>ICMP Checking</b> , the system will check connection by sending ICMP request packets to the destination specified in Target 1 and Target 2. |
| Loading Check                    | 1. An optional setting<br>2. Box is checked by default                  | Check the <b>Enable</b> box to activate the loading check function. Enable Loading Check allows the gateway to ignore unreturned DNS queries or ICMP requests when WAN bandwidth is fully occupied. This is to prevent false link-down status.  |
| Query Interval                   | 1. A Must filled setting<br>2. By default <b>3</b> seconds is filled-in | <b>Query Interval</b> defines the transmitting interval between two DNS Query or ICMP checking packets.   |
| Latency Threshold                | 1. A Must filled setting<br>2. By default <b>3000</b> ms is filled-in   | <b>Latency Threshold</b> defines the tolerance threshold of responding time.  |
| Fail Threshold                   | 1. A Must filled setting<br>2. By default <b>10</b> times is filled-in  | <b>Fail Threshold</b> specifies the detected disconnection before the router recognize the WAN link down status. Enter a number of detecting disconnection times to be the threshold before disconnection is acknowledged.  |
| Target 1                         | 1. An Optional filled setting<br>2. <b>DNS1</b> is selected by default  | <b>Target1</b> specifies the first target of sending DNS query/ICMP request.<br><b>DNS1</b> : set the primary DNS to be the target.<br><b>DNS2</b> : set the secondary DNS to be the target.<br><b>Gateway</b> : set the Current gateway to be the target.<br><b>Other Host</b> : enter an IP address to be the target.   |
| Target 2                         | 1. An Optional filled setting<br>2. <b>None</b> is selected by default  | <b>Target1</b> specifies the second target of sending DNS query/ICMP request.<br><b>None</b> : no second target is required.<br><b>DNS1</b> : set the primary DNS to be the target.<br><b>DNS2</b> : set the secondary DNS to be the target.<br><b>Gateway</b> : set the Current gateway to be the target.<br><b>Other Host</b> : enter an IP address to be the target.     |
| Save                             | N/A   | Click <b>Save</b> to save the settings.   |
| Undo                             | N/A   | Click <b>Undo</b> to cancel the settings.   |

### Internet Connection – WiFi Uplink WAN

If the device connects to Internet through WiFi Uplink, this section will help you to complete WiFi Uplink connection setup.

Go to **Basic Network > WAN & Uplink > Connection Setup** tab.

WiFi Uplink interface: The Uplink network is a wireless network, and the gateway can connect to the Uplink network through WiFi connection.

If you have the access permission to a certain wireless network, you can setup a WiFi Uplink connection by using the router device. This router can support 802.11n/g/b data connection, and it can connect to a wireless network (access point) under the regular infrastructure mode.

| Internet Connection List |                    |                |          |                                     |
|--------------------------|--------------------|----------------|----------|-------------------------------------|
| Interface Name           | Physical Interface | Operation Mode | WAN Type | Action                              |
| WAN-1                    | 3G/4G              | Always on      | 3G/4G    | <input type="button" value="Edit"/> |
| WAN-2                    | WiFi Module One    | Failover       | Uplink   | <input type="button" value="Edit"/> |

### Configure WiFi Uplink Setting

When **Edit** button is applied, **Internet Connection Configuration** screen will appear. WAN-2 interface is used in this example.

| Internet Connection Configuration ( WAN - 2 ) |                                     |
|---|-------------------------------------|
| Item  | Setting                             |
| ▶ WAN Type                                    | <input type="text" value="Uplink"/> |

| Internet Connection Configuration |   |   |
|-----------------------------------|---|---|
| Item                              | Value setting   | Description   |
| WAN Type                          | 1. A Must filled setting.<br>2. <b>Uplink</b> is selected by default. | From the dropdown box, select Internet connection method for WiFi Uplink Connection. Only <b>Uplink</b> is available. |



## WiFi Uplink

| WiFi Uplink WAN Type Configuration |  |
|------------------------------------|--|
| Item                               | Setting  |
| ▶ Connect to AP                    | default-Ch#12-Open (None) <input type="button" value="Scan"/>                                      |
| ▶ Network Type                     | <input type="text" value="NAT Mode"/>  |
| ▶ IP Mode                          | <input type="text" value="Dynamic IP"/>  |
| ▶ Host Name                        | <input type="text"/> (Optional)  |
| ▶ Fast Roaming                     | <input type="checkbox"/> Enable Signal Threshold <input type="text" value="40"/> %                 |
| ▶ Fast Roaming Channels            | <input type="text" value="N/A"/> <input type="text" value="N/A"/> <input type="text" value="N/A"/> |

| WiFi Uplink WAN Type Configuration |  |   |
|------------------------------------|--|---|
| Item                               | Value setting  | Description   |
| Connect to AP                      | N/A  | Display the information of AP for connecting. You can Click the <b>Scan</b> button and select an AP for the uplink network. Besides, you can also create uplink profile(s) for ease of connecting to an available Uplink network. Refer to <b>Basic Network &gt; WiFi &gt; Uplink Profile</b> tab.  |
| Network Type                       | 1. A Must filled setting<br>2. <b>NAT Mode</b> is selected by default.   | Select the expected network type for the WiFi Uplink connection. It can be <b>NAT Mode</b> , <b>Bridge Mode</b> , or <b>NAT Disable</b> .<br>When <b>NAT Mode</b> is selected, the NAT function is activated on the Wireless Uplink connection;<br>When <b>Bridge Mode</b> is selected, the bridge function is activated on the Wireless Uplink connection; The supporting of bridge mode depends on the product specification, if the purchased device doesn't support the bridge mode, it will be greyed out from selection.<br>When <b>NAT Disable</b> is selected, the NAT function is deactivated on the Wireless Uplink connection, and it can function as a router with manually configured routing setting. |
| IP Mode                            | 1. A Must filled setting<br>2. <b>Dynamic IP</b> is selected by default. | Specify the IP mode for the wireless uplink Interface. It can be <b>Dynamic IP</b> or <b>Static IP</b> .<br>When <b>Dynamic IP</b> is selected, the device will request a IP from the Uplink Network as the IP for the uplink interface ;<br>When <b>Static IP</b> is selected, you have to manually configure the IP address settings for the uplink interface. The settings include IP address, subnet mask, gateway, and primary/secondary DNS.  |
| Host Name                          | An Optional setting  | Specify the Host Name.  |
| Fast Roaming                       | 1. An Optional setting<br>2. <b>Unchecked</b> is selected by default.    | Click the <b>Enable</b> checkbox to activate the fast roaming function. In addition, you can also specify a threshold value for changing from one AP to another near-by AP. The default threshold value is 40%.<br><b>Value Range: 30 ~ 60%.</b>  |
| Fast Roaming Channels              | An Optional setting  | Select up to three fast roaming WiFi channels.  |

## Network Monitoring

| Network Monitoring Configuration   |  |
|------------------------------------|--|
| Item                               | Setting                                    |
| ▶ Network Monitoring Configuration | <input checked="" type="checkbox"/> Enable |
| ▶ Checking Method                  | DNS Query ▼                                |
| ▶ Loading Check                    | <input checked="" type="checkbox"/> Enable |
| ▶ Query Interval                   | 5 (seconds)                                |
| ▶ Latency Threshold                | 3000 (ms)                                  |
| ▶ Fail Threshold                   | 5 (Times)                                  |
| ▶ Target1                          | DNS1 ▼                                     |
| ▶ Target2                          | None ▼                                     |

| Network Monitoring Configuration |   |  |
|----------------------------------|---|--|
| Item                             | Value setting   | Description  |
| Network Monitoring Configuration | 1. An Optional setting<br>2. The box is <b>checked</b> by default.    | Click the <b>Enable</b> checkbox to activate the function.   |
| Checking Method                  | 1. An Optional setting<br>2. <b>DNS Query</b> is selected by default. | Choose either <b>DNS Query</b> or <b>ICMP Checking</b> method and specify a Query/Check Interval to detect WAN link.<br><br>With such configuration, the gateway will use DNS Query or ICMP Checking to periodically check Internet connection –connected or disconnected.   |
| Load Checking                    | 1. An optional setting<br>2. Enabled by default.                      | Click the <b>Enable</b> checkbox to activate the function.<br>Enable Loading Check allows the gateway to ignore unreturned DNS Queries or ICMP requests when WAN bandwidth is fully occupied. This is to prevent false link-down status.<br><b>Latency Threshold</b> defines the tolerance threshold of responding time.<br><b>Fail Threshold</b> specifies the detected disconnection before the router recognize the WAN link down status. Enter a number of detecting disconnection times to be the threshold before disconnection is acknowledged. |
| Query Interval                   | 1. An Optional setting<br>2. <b>5 seconds</b> is selected by default. | Specify a time interval as the <b>DNS Query Interval</b> .<br><b>Query Interval</b> defines the transmitting interval between two DNS Query or ICMP checking packets.<br>With <b>DNS Query</b> , the system checks the connection by sending DNS Query packets to the destination specified in Target 1 and Target 2.<br><b>Value Range: 2 ~ 14400.</b>  |

|                          |   |   |
|--------------------------|---|---|
| <b>Check Interval</b>    | 1. An Optional setting<br>2. <b>5 seconds</b> is selected by default. | Specify a time interval as the <b>ICMP Checking Interval</b> .<br><b>Query Interval</b> defines the transmitting interval between two DNS Query or ICMP checking packets.<br>With <b>ICMP Checking</b> , the system will check connection by sending ICMP request packets to the destination specified in Target 1 and Target 2.<br><b>Value Range: 2 ~ 14400.</b>  |
| <b>Latency Threshold</b> | 1. An Optional setting<br>2. <b>3000 ms</b> is selected by default.   | Specify a time interval as the <b>Latency Threshold</b> .<br><b>Latency Threshold</b> defines the tolerance threshold of responding time.   |
| <b>Fail Threshold</b>    | 1. An Optional setting<br>2. <b>5 times</b> is selected by default.   | Enter a number of detecting disconnection times to be the threshold before disconnection is acknowledged.<br><b>Fail Threshold</b> specifies the detected disconnection before the router recognize the WAN link down status.<br><b>Value Range: 1 ~ 10.</b>  |
| <b>Target 1</b>          | 1. An Optional setting<br>2. <b>DNS1</b> is selected by default.      | <b>Target1 (DNS1 set by default)</b> specifies the first target of sending DNS query/ICMP request.<br><ul style="list-style-type: none"> <li>■ <b>DNS1</b>: set the primary DNS to be the target.</li> <li>■ <b>DNS2</b>: set the secondary DNS to be the target.</li> <li>■ <b>Gateway</b>: set the Current gateway to be the target.</li> <li>■ <b>Other Host</b>: enter an IP address to be the target.</li> </ul>   |
| <b>Target 2</b>          | 1. An Optional setting<br>2. <b>None</b> is selected by default.      | <b>Target2 (None set by default)</b> specifies the second target of sending DNS query/ICMP request.<br><ul style="list-style-type: none"> <li>■ <b>None</b>: to disable <b>Target2</b>.</li> <li>■ <b>DNS1</b>: set the primary DNS to be the target.</li> <li>■ <b>DNS2</b>: set the secondary DNS to be the target.</li> <li>■ <b>Gateway</b>: set the Current gateway to be the target.</li> <li>■ <b>Other Host</b>: enter an IP address to be the target.</li> </ul> |
| <b>Save</b>              | N/A   | Click <b>Save</b> to save the settings.   |
| <b>Undo</b>              | N/A   | Click <b>Undo</b> to cancel the settings.   |

## 2.2 LAN & VLAN

This section provides the configuration of LAN and VLAN. VLAN is an optional feature, and it depends on the product specification of the purchased gateway.

### 2.2.1 Ethernet LAN

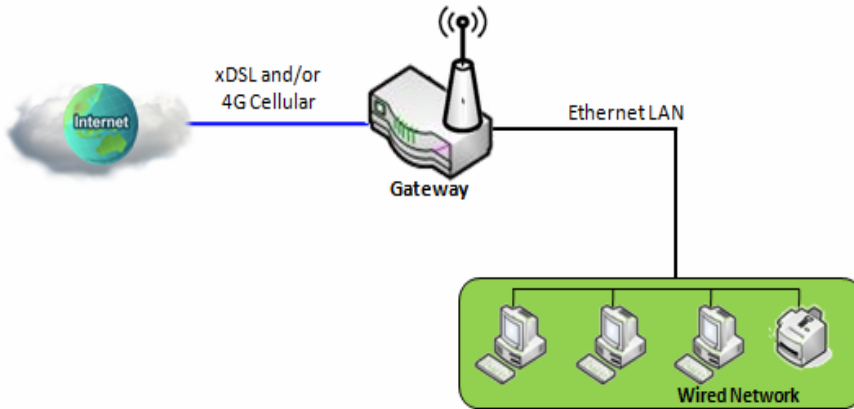

The Local Area Network (LAN) can be used to share data or files among computers attached to a network. Following diagram illustrates the network that wired and interconnects computers.

Please follow the following instructions to do IPv4 Ethernet LAN Setup.

| Configuration    |  |
|------------------|--|
| Item             | Setting  |
| ▶ IP Mode        | Static IP  |
| ▶ LAN IP Address | <input type="text" value="192.168.123.254"/>       |
| ▶ Subnet Mask    | <input type="text" value="255.255.255.0 (/24)"/> ▼ |

| Configuration  |  |  |
|----------------|--|--|
| Item           | Value setting  | Description  |
| IP Mode        | N/A  | It shows the LAN IP mode for the router according the related configuration.<br><b>Static IP:</b> If there is at least one WAN interface activated, the LAN IP mode is fixed in Static IP mode.<br><b>Dynamic IP:</b> If all the available WAN interfaces are disabled, the LAN IP mode can be Dynamic IP mode.                  |
| LAN IP Address | 1. A Must filled setting<br>2. 192.168.1.1 is set by default | Enter the local IP address of this device.<br>The network device(s) on your network must use the LAN IP address of this device as their Default Gateway. You can change it if necessary.<br><br><b>Note:</b> It's also the IP address of web UI. If you change it, you need to type new IP address in the browser to see web UI. |

|                    |   |   |
|--------------------|---|---|
| <b>Subnet Mask</b> | <ol style="list-style-type: none"> <li>1. A Must filled setting</li> <li>2. <b>255.255.255.0 (/24)</b> is set by default</li> </ol> | <p>Select the subnet mask for this gateway from the dropdown list. Subnet mask defines how many clients are allowed in one network or subnet. The default subnet mask is 255.255.255.0 (/24), and it means maximum 254 IP addresses are allowed in this subnet. However, one of them is occupied by LAN IP address of this gateway, so there are maximum 253 clients allowed in LAN network.</p> <p><b>Value Range:</b> 255.0.0.0 (/8) ~ 255.255.255.252 (/30).</p> |
| <b>Save</b>        | N/A   | Click the <b>Save</b> button to save the configuration  |
| <b>Undo</b>        | N/A   | Click the <b>Undo</b> button to restore what you just configured back to the previous setting.  |

## Create / Edit Additional IP

This router provides the LAN IP alias function for some special management consideration. You can add additional LAN IP for this router, and access to this router with the additional IP.

| <input type="checkbox"/> Additional IP <input type="button" value="Add"/> <input type="button" value="Delete"/> |      |           |            |             |        |        |
|---|------|-----------|------------|-------------|--------|--------|
| ID  | Name | Interface | IP Address | Subnet Mask | Enable | Action |

When **Add** button is applied, **Additional IP Configuration** screen will appear.

| <input type="checkbox"/> Additional IP Configuration |                          |
|--|--------------------------|
| Item   | Setting                  |
| ▶ Name   | <input type="text"/>     |
| ▶ Interface  | lo ▼                     |
| ▶ IP Address   | <input type="text"/>     |
| ▶ Subnet Mask  | 255.255.255.0 (/24) ▼    |
| ▶ Enable   | <input type="checkbox"/> |
| <input type="button" value="Save"/>                  |                          |

| Configuration     |   |   |
|-------------------|---|---|
| Item              | Value setting   | Description   |
| <b>Name</b>       | 1. An Optional Setting  | Enter the name for the alias IP address.                        |
| <b>Interface</b>  | <ol style="list-style-type: none"> <li>1. A Must filled setting</li> <li>2. <b>lo</b> is set by default</li> </ol>        | Specify the Interface type. It can be <b>lo</b> or <b>br0</b> . |
| <b>IP Address</b> | <ol style="list-style-type: none"> <li>1. An Optional setting</li> <li>2. <b>192.168.1.1 is set by default</b></li> </ol> | Enter the addition IP address for this device.                  |

|                           |   |   |
|---------------------------|---|---|
| <p><b>Subnet Mask</b></p> | <p>1. A Must filled setting<br/>2. <b>255.255.255.0 (/24)</b> is set by default</p> | <p>Select the subnet mask for this gateway from the dropdown list. Subnet mask defines how many clients are allowed in one network or subnet. The default subnet mask is 255.255.255.0 (/24), and it means maximum 254 IP addresses are allowed in this subnet. However, one of them is occupied by LAN IP address of this gateway, so there are maximum 253 clients allowed in LAN network.</p> <p><b>Value Range:</b> 255.0.0.0 (/8) ~ 255.255.255.255 (/32).</p> |
| <p><b>Save</b></p>        | <p>NA</p>   | <p>Click the <b>Save</b> button to save the configuration</p>   |

### 2.2.2 VLAN

VLAN (Virtual LAN) is a logical network under a certain switch or router device to group client hosts with a specific VLAN ID. This gateway supports both Port-based VLAN and Tag-based VLAN. These functions allow you to divide local network into different “virtual LANs”. It is common requirement for some application scenario. For example, there are various departments within SMB. All client hosts in the same department should own common access privilege and QoS property. You can assign departments either by port-based VLAN or tag-based VLAN as a group, and then configure it by your plan. In some cases, ISP may need router to support “VLAN tag” for certain kinds of services (e.g. IPTV). You can group all devices required this service as one tag-based VLAN.

#### ➤ Port-based VLAN

Port-based VLAN function can group Ethernet ports, Port-1 ~ Port-4, and WiFi Virtual Access Points, VAP-1 ~ VAP-8, together for differentiated services like Internet surfing, multimedia enjoyment, VoIP talking, and so on. Two operation modes, NAT and Bridge, can be applied to each VLAN group. One DHCP server can be allocated for a NAT VLAN group to let group host member get its IP address. Thus, each host can surf Internet via the NAT mechanism of business access gateway. In bridge mode, Intranet packet flow is delivered out WAN trunk port with VLAN tag to upper link for different services.

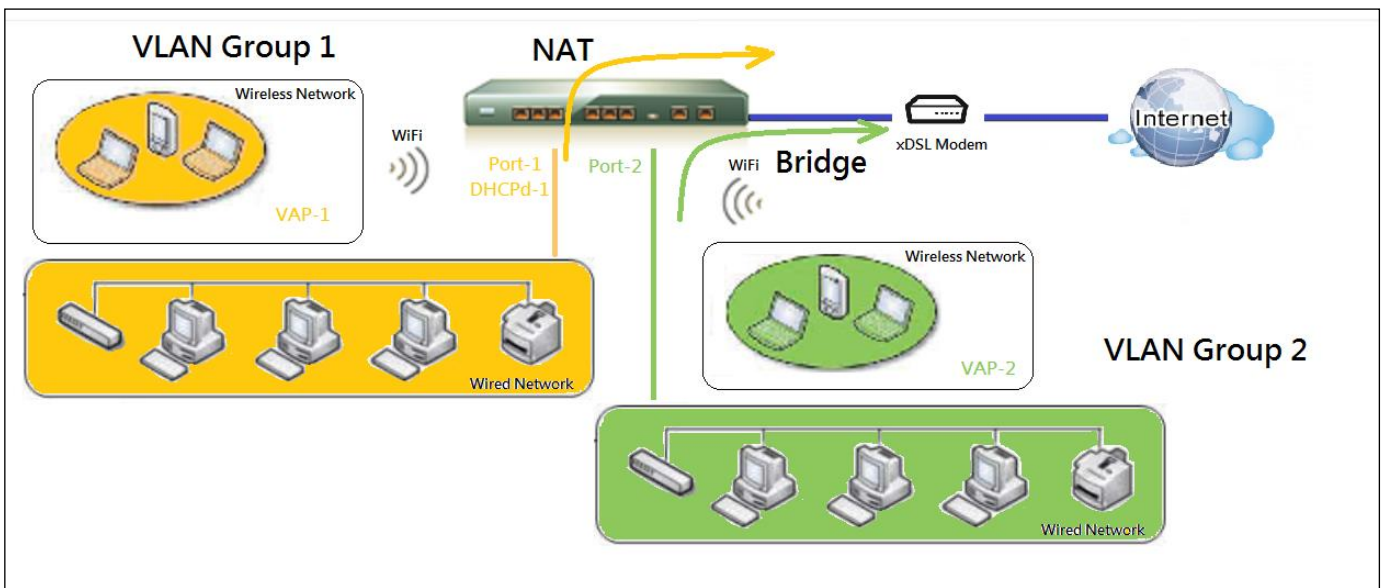

A port-based VLAN is a group of ports on an Ethernet or Virtual APs of Wired or Wireless Gateway that form a logical LAN segment. Following is an example.

For example, in a company, administrator schemes out 3 network segments, Lobby/Meeting Room, Office, and Data Center. In a Wireless Gateway, administrator can configure Lobby/Meeting Room segment with VLAN ID 3. The VLAN group includes Port-3 and VAP-8 (SSID: Guest) with NAT mode and DHCP-3 server equipped. He also configure Office segment with VLAN ID 2. The VLAN group includes Port-2 and VAP-1 (SSID: Staff) with NAT mode and DHCP-2 server equipped. At last, administrator also configure Data Center segment with VLAN ID 1. The VLAN group includes Ports Port-1 with NAT mode to WAN interface as shown in following diagram.

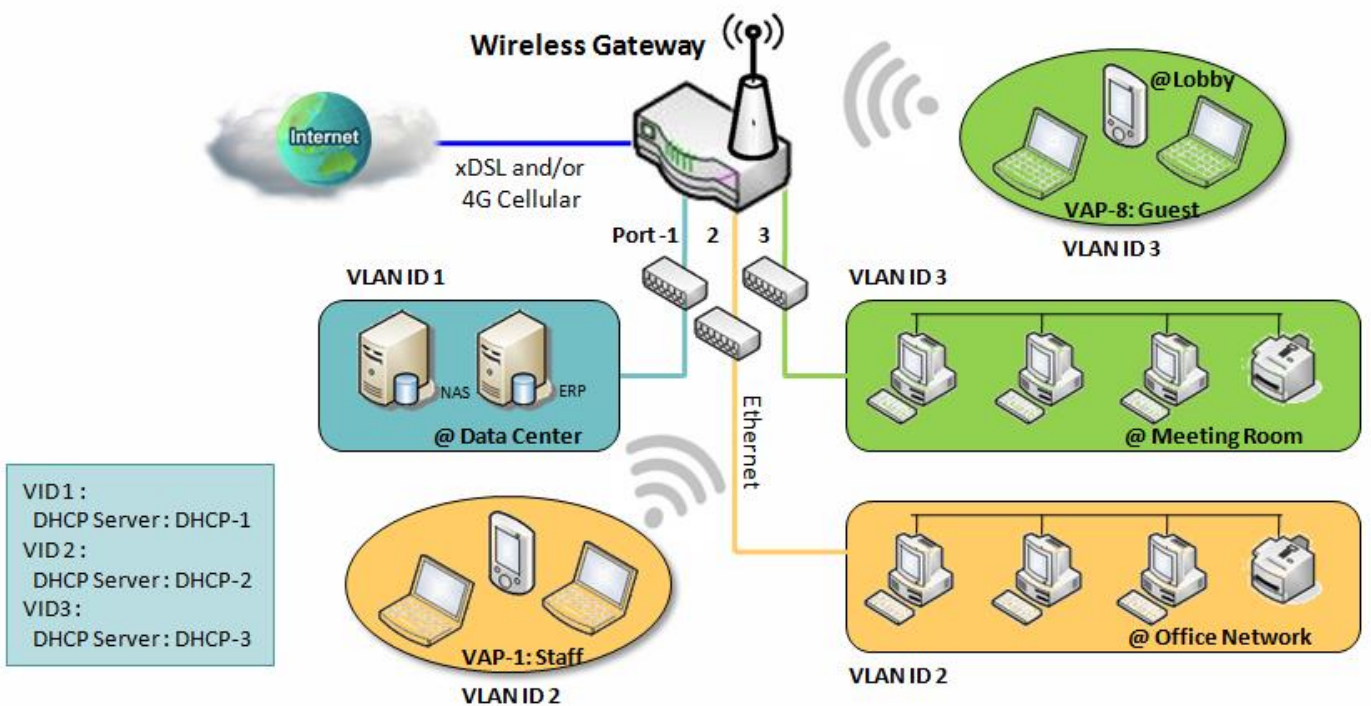

Above is the general case for 3 Ethernet LAN ports in the gateway. But if the device just has one Ethernet LAN port, there will be only one VLAN group for the device. Under such situation, it still supports both the NAT and Bridge mode for the Port-based VLAN configuration.

## ➤ Tag-based VLAN

Tag-based VLAN function can group Ethernet ports, Port-1 ~ Port-4, and WiFi Virtual Access Points, VAP-1 ~ VAP-8, together with different VLAN tags for deploying subnets in Intranet. All packet flows can carry with different VLAN tags even at the same physical Ethernet port for Intranet. These flows can be directed to different destination because they have differentiated tags. The approach is very useful to group some hosts at different geographic location to be in the same workgroup.

Tag-based VLAN is also called a VLAN Trunk. The VLAN Trunk collects all packet flows with different VLAN IDs from Router device and delivers them in the Intranet. VLAN membership in a tagged VLAN is determined by VLAN ID information within the packet frames that are received on a port. Administrator can further use a VLAN switch to separate the VLAN trunk to different groups based on VLAN ID. Following is an example.

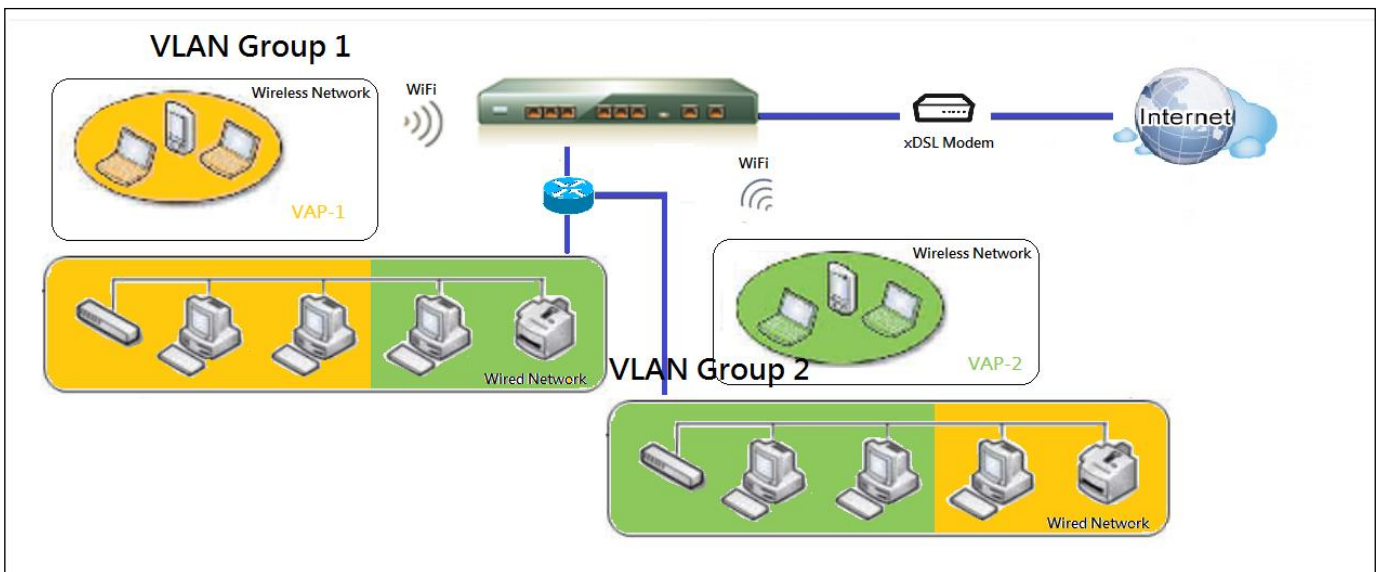

For example, in a company, administrator schemes out 3 network segments, Lab, Meeting Rooms, and Office. In a Security VPN Gateway, administrator can configure Office segment with VLAN ID 12. The VLAN group is equipped with DHCP-3 server to construct a 192.168.12.x subnet. He also configure Meeting Rooms segment with VLAN ID 11. The VLAN group is equipped with DHCP-2 server to construct a 192.168.11.x subnet for Intranet only. That is, any client host in VLAN 11 group can't access the Internet. At last, he configures Lab segment with VLAN ID 10. The VLAN group is equipped with DHCP-1 server to construct a 192.168.10.x subnet.



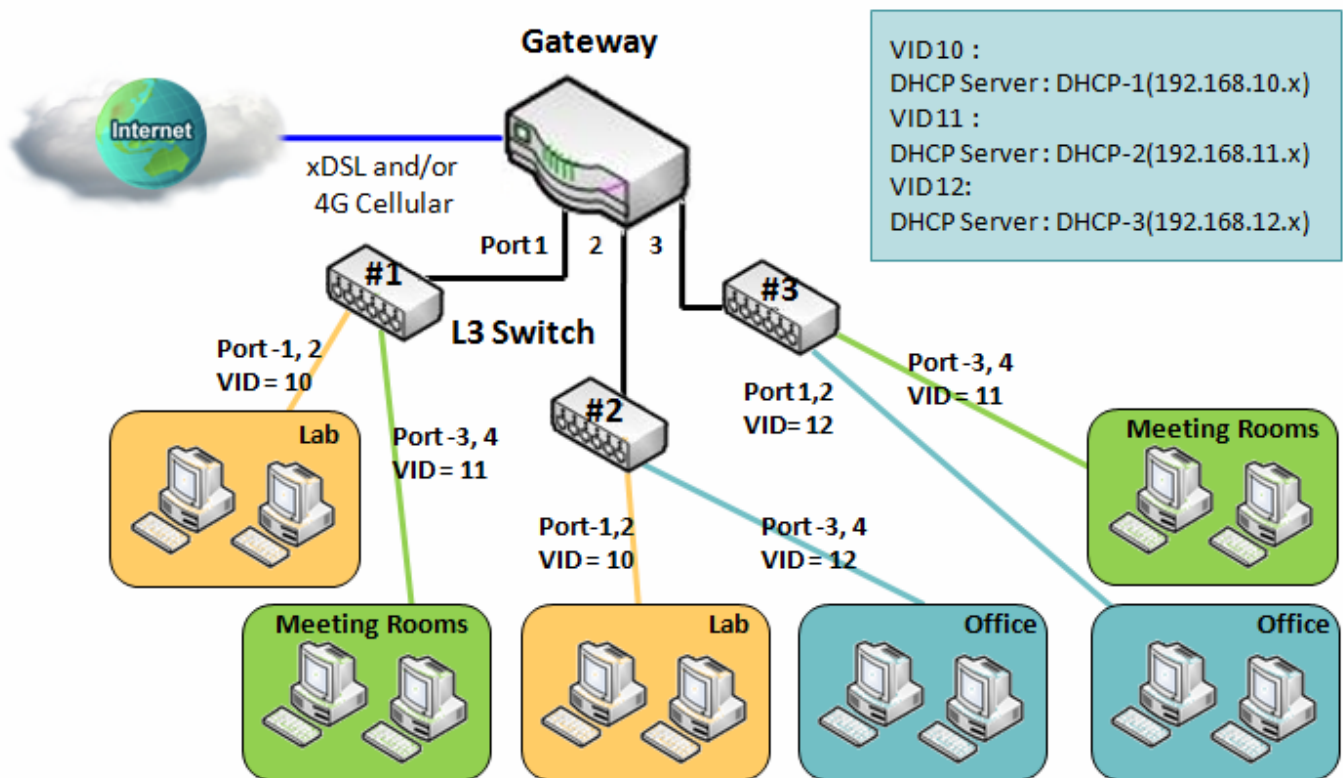

## ➤ VLAN Groups Access Control

Administrator can specify the Internet access permission for all VLAN groups. He can also configure which VLAN groups are allowed to communicate with each other.

## VLAN Group Internet Access

Administrator can specify members of one VLAN group to be able to access Internet or not. Following is an example that VLAN groups of VID is 2 and 3 can access Internet but the one with VID is 1 cannot access Internet. That is, visitors in meeting room and staffs in office network can access Internet. But the computers/servers in data center cannot access Internet since security consideration. Servers in data center only for trusted staffs or are accessed in secure tunnels.

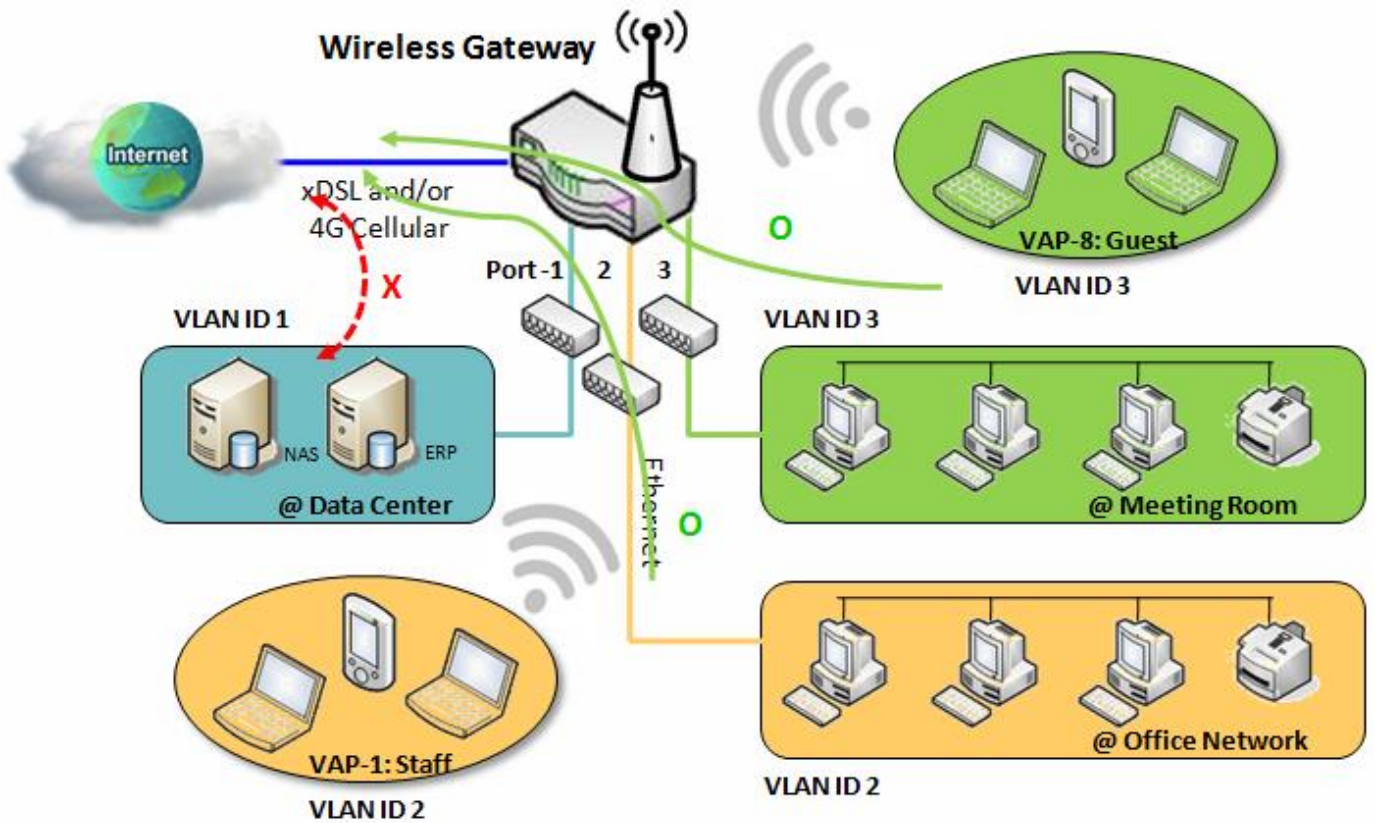

### Inter VLAN Group Routing

In Port-based tagging, administrator can specify member hosts of one VLAN group to be able to communicate with the ones of another VLAN group or not. This is a communication pair, and one VLAN group can join many communication pairs. But communication pair doesn't have the transitive property. That is, A can communicate with B, and B can communicate with C, it doesn't imply that A can communicate with C. An example is shown at following diagram. VLAN groups of VID is 1 and 2 can access each other but the ones between VID 1 and VID 3 and between VID 2 and VID 3 can't.

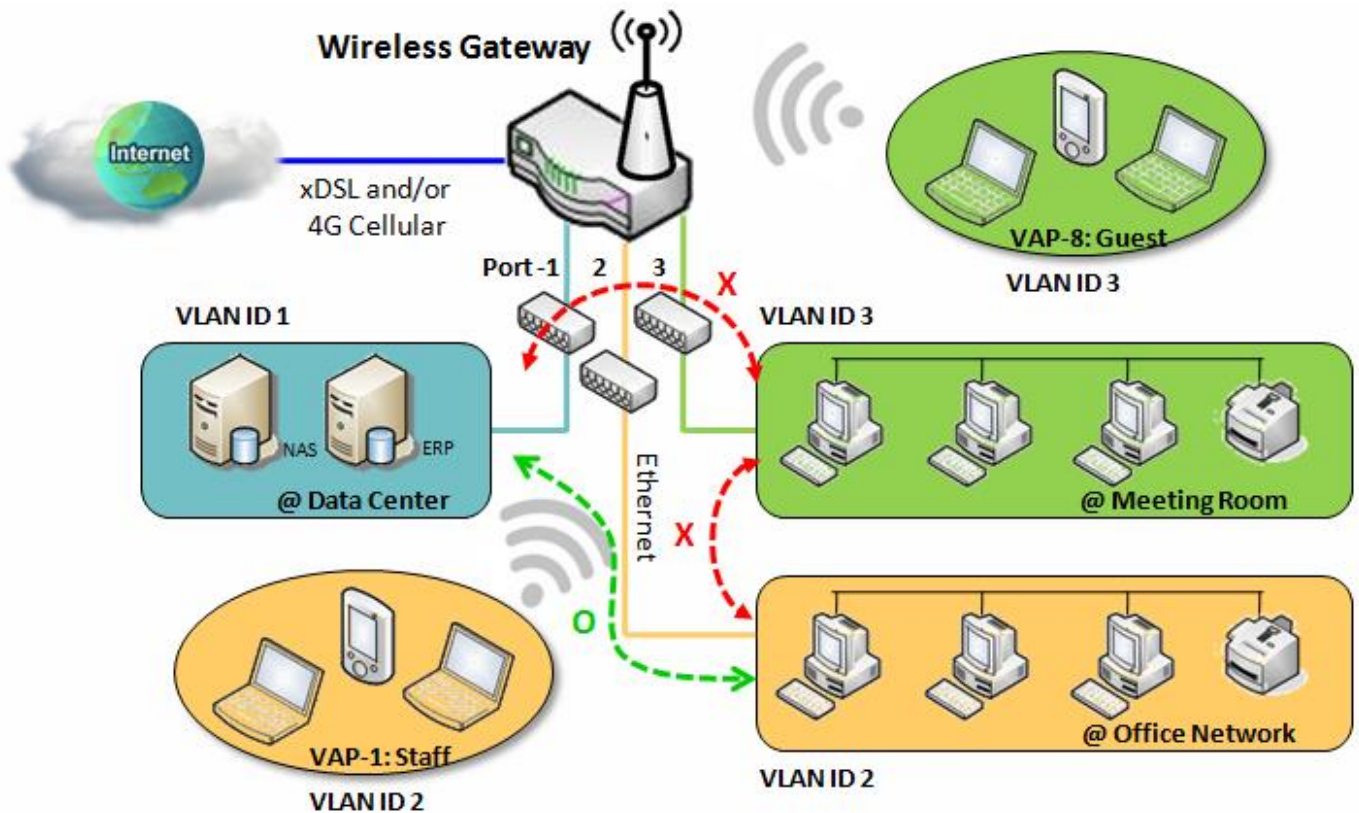

## VLAN Setting

Go to **Basic Network > LAN & VLAN > VLAN** Tab.

The VLAN function allows you to divide local network into different virtual LANs. There are Port-based and Tag-based VLAN types. Select one that applies.

| Configuration [ Help ]    |  |
|---------------------------|--|
| Item                      | Setting  |
| ▶ VLAN Types              | Port-based ▾   |
| ▶ System Reserved VLAN ID | Start ID <input type="text" value="1"/> (1-4091) ~ End ID <input type="text" value="5"/> |

| Configuration |                                   |   |
|---------------|-----------------------------------|---|
| Item          | Value setting                     | Description   |
| VLAN Type     | Port-based is selected by default | Select the VLAN type that you want to adopt for organizing your local subnets.<br><b>Port-based:</b> Port-based VLAN allows you to add rule for each LAN port, and you can do advanced control with its VLAN ID.<br><b>Tag-based:</b> Tag-based VLAN allows you to add VLAN ID, and select member and DHCP Server for this VLAN ID. Go to <b>Tag-based VLAN List</b> table. |

|                                |                       |  |
|--------------------------------|-----------------------|--|
| <b>System Reserved VLAN ID</b> | A Must filled setting | Define the <b>Start ID</b> for the VLAN and the <b>End ID</b> will be automatically counted as Start ID + 4.<br><br><i>Value Range: 1 ~ 4091</i> |
| <b>Save</b>                    | NA                    | Click the <b>Save</b> button to save the configuration   |

## Port-based VLAN – Create/Edit VLAN Rules

The port-based VLAN allows you to custom each LAN port. There is a default rule shows the configuration of all LAN ports. Also, if your device has a DMZ port, you will see DMZ configuration, too. The maxima rule numbers is based on LAN port numbers.

| Port-based VLAN List <input type="button" value="Add"/> <input type="button" value="Delete"/> |                   |              |              |                                       |                |               |            |         |                                     |  |
|---|-------------------|--------------|--------------|---------------------------------------|----------------|---------------|------------|---------|-------------------------------------|--|
| Name  | VLAN ID           | VLAN Tagging | NAT / Bridge | Port Members                          | LAN IP Address | Subnet Mask   | Joined WAN | WAN VID | Enable                              | Actions  |
| LAN   | Native VLAN Tag 1 | X            | NAT          | <input type="button" value="Detail"/> | 10.40.28.246   | 255.255.252.0 | All WANs   | 0       | <input checked="" type="checkbox"/> | <input type="button" value="Edit"/>                                    |
| VLAN - 1  | 10                | X            | NAT          | <input type="button" value="Detail"/> | 192.168.2.254  | 255.255.255.0 | WAN - 1    | 0       | <input type="checkbox"/>            | <input type="button" value="Edit"/><br><input type="checkbox"/> Select |

When **Add** button is applied, Port-based VLAN Configuration screen will appear, which is including 3 sections: **Port-based VLAN Configuration**, **IP Fixed Mapping Rule List**, and **Inter VLAN Group Routing** (enter through a button)

**Port-based VLAN - Configuration**

| Port-based VLAN Configuration |  |
|-------------------------------|--|
| Item                          | Setting  |
| ▶ Name                        | VLAN - 1   |
| ▶ VLAN ID                     |  |
| ▶ VLAN Tagging                | Disable ▾  |
| ▶ NAT / Bridge                | NAT ▾  |
| ▶ Port Members                | Port: <input type="checkbox"/> PORT-1 <input type="checkbox"/> PORT-2  |
| ▶ LAN to Join                 | <input type="checkbox"/> Enable <input type="text" value="DHCP 1"/> ▾  |
| ▶ WAN & WAN VID to Join       | <input type="text" value="All WANs"/> ▾ <input type="text" value="None"/>  |
| ▶ LAN IP Address              | 192.168.2.254  |
| ▶ Subnet Mask                 | 255.255.255.0 (/24) ▾  |
| ▶ DHCP Server / Relay         | Server ▾   |
| ▶ DHCP Server Name            |  |
| ▶ IP Pool                     | Starting Address: <input type="text" value="192.168.2.100"/><br>Ending Address: <input type="text" value="192.168.2.200"/> |
| ▶ Lease Time                  | <input type="text" value="86400"/> seconds   |
| ▶ Domain Name                 | <input type="text"/> (Optional)  |
| ▶ Primary DNS                 | <input type="text"/> (Optional)  |
| ▶ Secondary DNS               | <input type="text"/> (Optional)  |
| ▶ Primary WINS                | <input type="text"/> (Optional)  |
| ▶ Secondary WINS              | <input type="text"/> (Optional)  |
| ▶ Gateway                     | <input type="text"/> (Optional)  |
| ▶ Enable                      | <input type="checkbox"/>   |

| Port-based VLAN Configuration                |  |  |
|--|--|--|
| Item   | Value setting  | Description  |
| Name   | 1. A Must filled setting<br>2. String format: already have default texts | Define the <b>Name</b> of this rule. It has a default text and cannot be modified.   |
| VLAN ID                                      | A Must filled setting  | Define the VLAN ID number, range is 1~4094.  |
| VLAN Tagging                                 | <b>Disable</b> is selected by default.                                   | The rule is activated according to <b>VLAN ID</b> and <b>Port Members</b> configuration when <b>Enable</b> is selected.<br><br>The rule is activated according <b>Port Members</b> configuration when <b>Disable</b> is selected.  |
| NAT / Bridge                                 | <b>NAT</b> is selected by default.                                       | Select <b>NAT</b> mode or <b>Bridge</b> mode for the rule.   |
| Port Members                                 | These box is unchecked by default.                                       | Select which LAN port(s) and VAP(s) that you want to add to the rule.<br>Note: The available member list can be different for the purchased product.   |
| LAN to Join                                  | 1. An Optional Setting<br>2. The box is unchecked by default.            | Select the LAN to join.  |
| WAN & WAN VID to Join                        | <b>All WANs</b> is selected by default.                                  | Select which <b>WAN</b> or <b>All WANs</b> that allow accessing Internet.<br>Note: If Bridge mode is selected, you need to select a WAN and enter a VID.   |
| LAN IP Address                               | A Must filled setting  | Assign an <b>IP Address</b> for the DHCP Server that the rule used, this IP address is a gateway IP.   |
| Subnet Mask                                  | <b>255.255.255.0(/24)</b> is selected by default.                        | Select a <b>Subnet Mask</b> for the DHCP Server.   |
| DHCP Server /Relay                           | <b>Server</b> is selected by default.                                    | Define the <b>DHCP Server</b> type.<br>There are three types you can select: <b>Server</b> , <b>Relay</b> , and <b>Disable</b> .<br><b>Relay</b> : Select <b>Relay</b> to enable DHCP Relay function for the VLAN group, and you only need to fill the <b>DHCP Server IP Address</b> field.<br><b>Server</b> : Select <b>Server</b> to enable DHCP Server function for the VLAN group, and you need to specify the DHCP Server settings.<br><b>Disable</b> : Select <b>Disable</b> to disable the DHCP Server function for the VLAN group. |
| DHCP Server IP Address (for DHCP Relay only) | A Must filled setting  | If you select <b>Relay</b> type of DHCP Server, assign a <b>DHCP Server IP Address</b> that the gateway will relay the DHCP requests to the assigned DHCP server.  |
| DHCP Server Name                             | A Must filled setting  | Define name of the DHCP Server for the specified VLAN group.   |
| IP Pool                                      | A Must filled setting  | Define the IP Pool range.<br>There are <b>Starting Address</b> and <b>Ending Address</b> fields. If a client requests an IP address from this DHCP Server, it will assign an IP address in the range of <b>IP pool</b> .   |
| Lease Time                                   | A Must filled setting  | Define a period of time for an IP Address that the DHCP Server leases to a new device. By default, the <b>lease time</b> is 86400 seconds.   |
| Domain Name                                  | String format can be any text  | The Domain Name of this DHCP Server.<br><b>Value Range: 0 ~ 31 characters.</b>   |
| Primary DNS                                  | IPv4 format  | The Primary DNS of this DHCP Server.   |
| Secondary DNS                                | IPv4 format  | The Secondary DNS of this DHCP Server.   |
| Primary WINS                                 | IPv4 format  | The Primary WINS of this DHCP Server.  |
| Secondary WINS                               | IPv4 format  | The Secondary WINS of this DHCP Server.  |
| Gateway                                      | IPv4 format  | The Gateway of this DHCP Server.   |

|               |                                  |  |
|---------------|----------------------------------|--|
| <b>Enable</b> | The box is unchecked by default. | Click <b>Enable</b> box to activate this rule.   |
| <b>Save</b>   | NA                               | Click the <b>Save</b> button to save the configuration   |
| <b>Undo</b>   | NA                               | Click the <b>Undo</b> button to restore what you just configured back to the previous setting. |

Besides, you can add some IP rules in the **IP Fixed Mapping Rule List** if DHCP Server for the VLAN groups is required.

▣ IP Fixed Mapping Rule List

| MAC Address                               | IP Address                               | Enable | Actions |
|---|--|--------|---------|
| <span>▣ Mapping Rule Configuration</span> |  |        |         |
| Item                                      | Setting                                  |        |         |
| ▶ MAC Address                             | <input style="width: 90%;" type="text"/> |        |         |
| ▶ IP Address                              | <input style="width: 90%;" type="text"/> |        |         |
| ▶ Enable                                  | <input type="checkbox"/>                 |        |         |
| <input type="button" value="Save"/>       |  |        |         |

When **Add** button is applied, **Mapping Rule Configuration** screen will appear.

| Mapping Rule Configuration |                                  |   |
|----------------------------|----------------------------------|---|
| Item                       | Value setting                    | Description   |
| <b>MAC Address</b>         | A Must filled setting            | Define the <b>MAC Address</b> target that the DHCP Server wants to match.   |
| <b>IP Address</b>          | A Must filled setting            | Define the <b>IP Address</b> that the DHCP Server will assign.<br>If there is a request from the MAC Address filled in the above field, the DHCP Server will assign this <b>IP Address</b> to the client whose <b>MAC Address</b> matched the rule. |
| <b>Enable</b>              | The box is unchecked by default. | Click <b>Enable</b> box to activate this rule.  |
| <b>Save</b>                | NA                               | Click the <b>Save</b> button to save the configuration  |

**Note:** ensure to always click on **Apply** button to apply the changes after the web browser refreshed taken you back to the VLAN page.

| Port-based VLAN List <input type="button" value="Add"/> <input type="button" value="Delete"/> |                   |              |              |                                       |                |               |            |         |                                     |  |
|---|-------------------|--------------|--------------|---------------------------------------|----------------|---------------|------------|---------|-------------------------------------|--|
| Name  | VLAN ID           | VLAN Tagging | NAT / Bridge | Port Members                          | LAN IP Address | Subnet Mask   | Joined WAN | WAN VID | Enable                              | Actions  |
| LAN   | Native VLAN Tag 1 | X            | NAT          | <input type="button" value="Detail"/> | 10.40.28.246   | 255.255.252.0 | All WANs   | 0       | <input checked="" type="checkbox"/> | <input type="button" value="Edit"/>  |
| VLAN - 1  | 10                | X            | NAT          | <input type="button" value="Detail"/> | 192.168.2.254  | 255.255.255.0 | WAN - 1    | 0       | <input type="checkbox"/>            | <input type="button" value="Edit"/><br><input type="button" value="Select"/> |

Please Click Apply button to take effect.

### Port-based VLAN – Inter VLAN Group Routing

Click **VLAN Group Routing** button, the **VLAN Group Internet Access Definition** and **Inter VLAN Group Routing** screen will appear.

| VLAN Group Internet Access Definition |            |   |
|---------------------------------------|------------|---|
| VLAN IDs                              | Members    | Internet Access(WAN)                      |
| 1                                     | Port : 1,2 | Allow <input type="button" value="Edit"/> |

| Inter VLAN Group Routing |         |                                     |
|--------------------------|---------|-------------------------------------|
| VLAN IDs                 | Members | Action                              |
|                          |         | <input type="button" value="Edit"/> |
|                          |         | <input type="button" value="Edit"/> |
|                          |         | <input type="button" value="Edit"/> |
|                          |         | <input type="button" value="Edit"/> |

When **Edit** button is applied, a screen similar to this will appear.



| <input type="checkbox"/> VLAN Group Internet Access Definition               |            |   |
|--|------------|---|
| VLAN IDs   | Members    | Internet Access(WAN)                      |
| <input checked="" type="checkbox"/> 1, <input checked="" type="checkbox"/> 2 | Port : 1 2 | Allow <input type="button" value="Edit"/> |
| <input type="checkbox"/> Inter VLAN Group Routing                            |            |   |
| VLAN IDs   | Members    | Action                                    |
| <input type="checkbox"/> 1, <input type="checkbox"/> 2                       |            | <input type="button" value="Edit"/>       |

| Inter VLAN Group Routing                     |                                   |   |
|--|-----------------------------------|---|
| Item   | Value setting                     | Description   |
| <b>VALN Group Internet Access Definition</b> | All boxes are checked by default. | By default, all boxes are checked means all <b>VLAN ID</b> members are allow to access WAN interface.<br>If uncheck a certain <b>VLAN ID</b> box, it means the VLAN ID member can't access Internet anymore.<br>Note: <b>VLAN ID 1</b> is available always; it is the default VLAN ID of <b>LAN</b> rule. The other <b>VLAN IDs</b> are available only when they are enabled. |
| <b>Inter VLAN Group Routing</b>              | The box is unchecked by default.  | Click the expected VLAN IDs box to enable the Inter VLAN access function.<br>By default, members in different VLAN IDs can't access each other. The gateway supports up to 4 rules for <b>Inter VLAN Group Routing</b> .<br>For example, if ID_1 and ID_2 are checked, it means members in VLAN ID_1 can access members of VLAN ID_2, and vice versa.                         |
| <b>Save</b>                                  | N/A                               | Click the <b>Save</b> button to save the configuration  |

## Tag-based VLAN – Create/Edit VLAN Rules

The **Tag-based VLAN** allows you to customize each LAN port according to VLAN ID. There is a default rule shows the configuration of all LAN ports and all VAPs. Also, if your device has a DMZ port, you will see DMZ configuration, too. The router supports up to a maximum of 128 tag-based VLAN rule sets.

| <input type="checkbox"/> Tag-based VLAN List <input type="button" value="Add"/> <input type="button" value="Delete"/> |                                     |   |                  |            |             |  |
|---|-------------------------------------|---|------------------|------------|-------------|--|
| VLAN ID   | Internet                            | Port Members  | Bridge Interface | IP Address | Subnet Mask | Actions  |
| Native VLAN   | <input checked="" type="checkbox"/> | Port: <input checked="" type="checkbox"/> Port-1 <input checked="" type="checkbox"/> Port-2 | DHCP 1           |            |             | <input type="button" value="Edit"/> <input type="checkbox"/><br>Select |

When **Add** button is applied, **Tag-based VLAN Configuration** screen will appear.

| Tag-based VLAN Configuration        |   |
|-------------------------------------|---|
| Item                                | Setting   |
| ▶ VLAN ID                           | <input type="text" value="0"/>  |
| ▶ Internet Access                   | <input checked="" type="checkbox"/> Enable                            |
| ▶ Port Members                      | Port: <input type="checkbox"/> Port-1 <input type="checkbox"/> Port-2 |
| ▶ Bridge Interface                  | <input type="text" value="DHCP 1"/>                                   |
| <input type="button" value="Save"/> |   |

| Tag-based VLAN Configuration |                                       |  |
|------------------------------|---------------------------------------|--|
| Item                         | Value setting                         | Description  |
| <b>VLAN ID</b>               | A Must filled setting                 | Define the <b>VLAN ID</b> number, range is 6~4094.   |
| <b>Internet Access</b>       | The box is checked by default.        | Click <b>Enable</b> box to allow the members in the VLAN group access to internet.   |
| <b>Port</b>                  | The box is unchecked by default.      | Check the LAN port box(-es) to join the VLAN group.  |
| <b>VAP</b>                   | The box is unchecked by default.      | Check the VAP box(-es) to join the VLAN group.<br>Note: Only the wireless gateway has the VAP list.  |
| <b>DHCP Server</b>           | <b>DHCP 1</b> is selected by default. | Select a <b>DHCP Server</b> to these members of this VLAN group.<br>To create or edit DHCP server for VLAN, refer to <b>Basic Network &gt; LAN &amp; VLAN &gt; DHCP Server</b> . |
| <b>Save</b>                  | N/A                                   | Click <b>Save</b> button to save the configuration<br>Note: After clicking <b>Save</b> button, always click <b>Apply</b> button to apply the settings.                           |

2.2.3 DHCP Server

➤ DHCP Server

The gateway supports up to 4 DHCP servers to fulfill the DHCP requests from different VLAN groups (please refer to VLAN section for getting more usage details). And there is one default setting for whose LAN IP Address is the same one of router LAN interface, with its default Subnet Mask setting as “255.255.255.0”, and its default IP Pool ranges is from “.100” to “.200” as shown at the DHCP Server List page on router’s WEB UI.

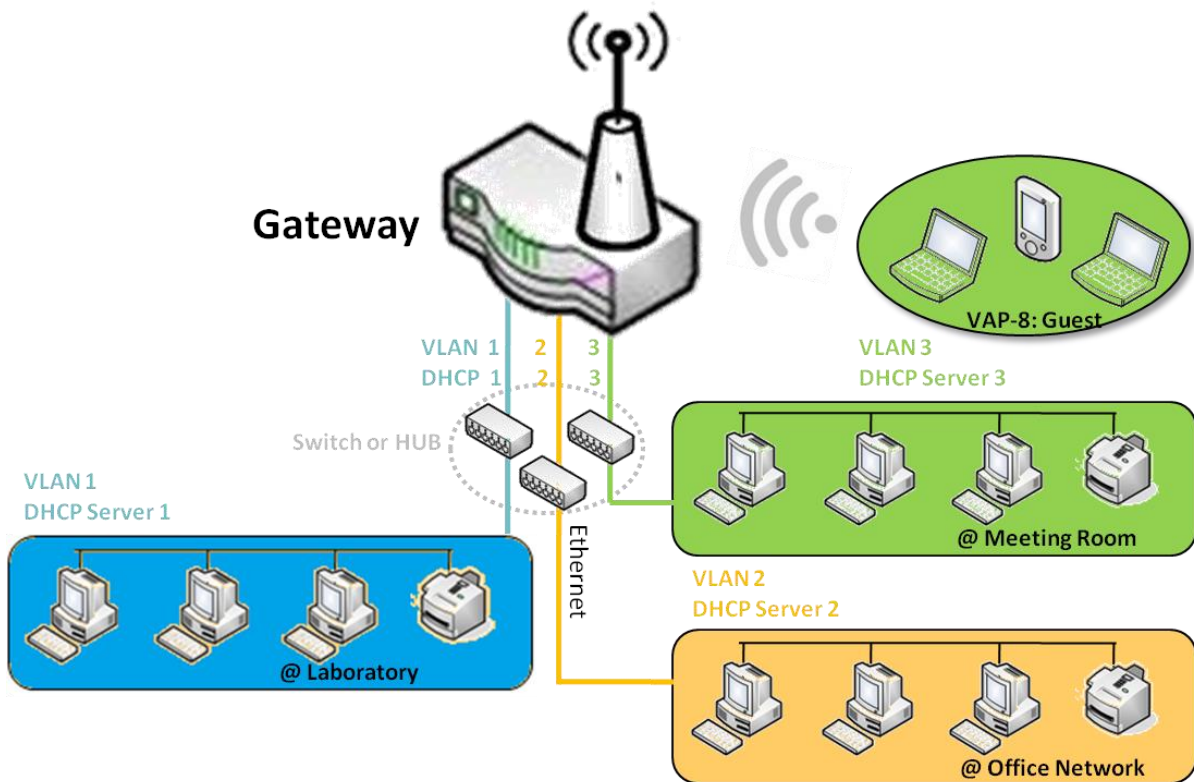

User can add more DHCP server configurations by clicking on the “Add” button behind “DHCP Server List”, or clicking on the “Edit” button at the end of each DHCP Server on list to edit its current settings. Besides, user can select a DHCP Server and delete it by clicking on the “Select” check-box and the “Delete” button.

➤ **Fixed Mapping**

User can assign fixed IP address to map the specific client MAC address by select them then copy, when targets were already existed in the **DHCP Client List**, or to add some other Mapping Rules by manually in advance, once the target's MAC address was not ready to connect.

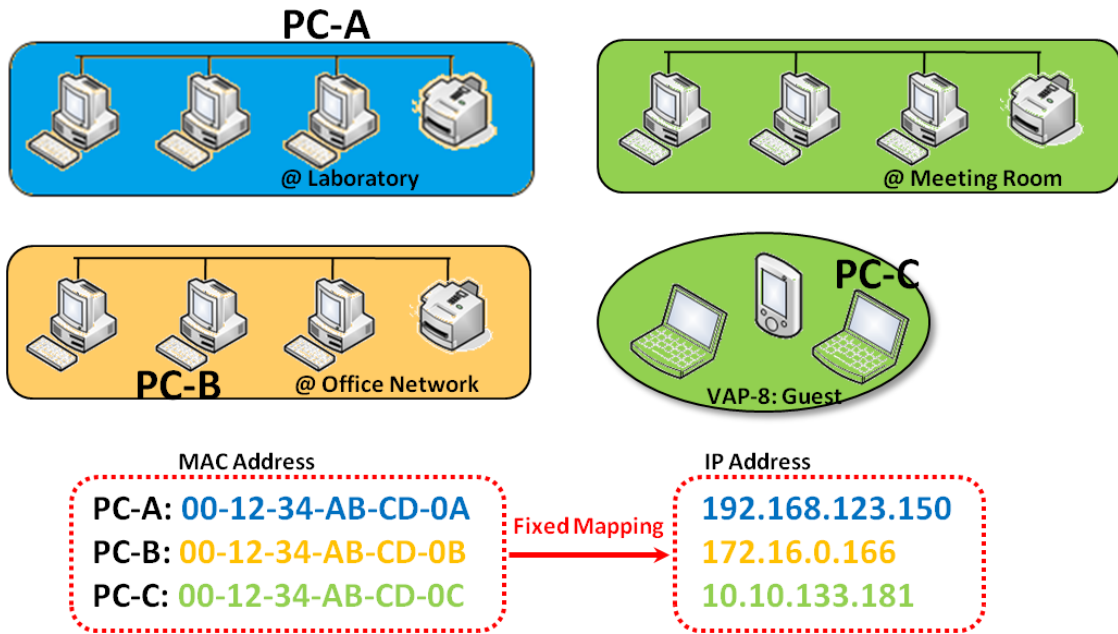

**DHCP Server Setting**

Go to **Basic Network > LAN & VLAN > DHCP Server** Tab.

The DHCP Server setting allows user to create and customize DHCP Server policies to assign IP Addresses to the devices on the local area network (LAN).

**Create / Edit DHCP Server Policy**

The router allows you to custom your DHCP Server Policy. If multiple LAN ports are available, you can define one policy for each LAN (or VLAN group), and it supports up to a maximum of 4 policy sets.

| DHCP Server List |                 |               |                                 |            |             |             |               |              |                |         |                                     | [ Help ]              |
|------------------|-----------------|---------------|---------------------------------|------------|-------------|-------------|---------------|--------------|----------------|---------|-------------------------------------|-----------------------|
| DHCP Server Name | LAN IP Address  | Subnet Mask   | IP Pool                         | Lease Time | Domain Name | Primary DNS | Secondary DNS | Primary WINS | Secondary WINS | Gateway | Enable                              | Actions               |
| DHCP 1           | 192.168.123.254 | 255.255.255.0 | 192.168.123.200-192.168.123.240 | 86400      |             | 0.0.0.0     | 0.0.0.0       | 0.0.0.0      | 0.0.0.0        | 0.0.0.0 | <input checked="" type="checkbox"/> | Edit<br>Fixed Mapping |

When **Add** button is applied, **DHCP Server Configuration** screen will appear.

| DHCP Server Configuration |  |
|---------------------------|--|
| Item                      | Setting  |
| ▶ DHCP Server Name        | <input type="text" value="DHCP 2"/>  |
| ▶ LAN IP Address          | <input type="text" value="192.168.2.254"/>                                     |
| ▶ Subnet Mask             | <input type="text" value="255.0.0.0 (/8)"/>                                    |
| ▶ IP Pool                 | Starting Address: <input type="text"/><br>Ending Address: <input type="text"/> |
| ▶ Lease Time              | <input type="text" value="86400"/> seconds                                     |
| ▶ Domain Name             | <input type="text"/> (Optional)  |
| ▶ Primary DNS             | <input type="text"/> (Optional)  |
| ▶ Secondary DNS           | <input type="text"/> (Optional)  |
| ▶ Primary WINS            | <input type="text"/> (Optional)  |
| ▶ Secondary WINS          | <input type="text"/> (Optional)  |
| ▶ Gateway                 | <input type="text"/> (Optional)  |
| ▶ Server                  | <input type="checkbox"/> Enable  |

| DHCP Server Configuration |  |  |
|---------------------------|--|--|
| Item                      | Value setting  | Description  |
| <b>DHCP Server Name</b>   | 1. String format can be any text<br>2. A Must filled setting | Enter a DHCP Server name. Enter a name that is easy for you to understand.   |
| <b>LAN IP Address</b>     | 1. IPv4 format.<br>2. A Must filled setting                  | The LAN IP Address of this DHCP Server.  |
| <b>Subnet Mask</b>        | 255.0.0.0 (/8) is set by default                             | The Subnet Mask of this DHCP Server.   |
| <b>IP Pool</b>            | 1. IPv4 format.<br>2. A Must filled setting                  | The IP Pool of this DHCP Server. It composed of Starting Address entered in this field and Ending Address entered in this field. |
| <b>Lease Time</b>         | 1. Numeric string format.<br>2. A Must filled setting        | The Lease Time of this DHCP Server.<br><b>Value Range: 300 ~ 604800 seconds.</b>   |
| <b>Domain Name</b>        | String format can be any text                                | The Domain Name of this DHCP Server.   |
| <b>Primary DNS</b>        | IPv4 format  | The Primary DNS of this DHCP Server.   |
| <b>Secondary DNS</b>      | IPv4 format  | The Secondary DNS of this DHCP Server.   |
| <b>Primary WINS</b>       | IPv4 format  | The Primary WINS of this DHCP Server.  |

|                       |                                  |  |
|-----------------------|----------------------------------|--|
| <b>Secondary WINS</b> | IPv4 format                      | The Secondary WINS of this DHCP Server.  |
| <b>Gateway</b>        | IPv4 format                      | The Gateway of this DHCP Server.   |
| <b>Server</b>         | The box is unchecked by default. | Click <b>Enable</b> box to activate this DHCP Server.  |
| <b>Save</b>           | N/A                              | Click the <b>Save</b> button to save the configuration   |
| <b>Undo</b>           | N/A                              | Click the <b>Undo</b> button to restore what you just configured back to the previous setting.       |
| <b>Back</b>           | N/A                              | When the <b>Back</b> button is clicked the screen will return to the DHCP Server Configuration page. |

## Create / Edit Mapping Rule List on DHCP Server

The router allows you to custom your Mapping Rule List on DHCP Server. It supports up to a maximum of 64 rule sets. When **Fix Mapping** button is applied, the **Mapping Rule List** screen will appear.

|   |            |        |         |
|---|------------|--------|---------|
| <input type="checkbox"/> Mapping Rule List <input type="button" value="Add"/> <input type="button" value="Delete"/> <span style="float: right;">[ Help ]</span> |            |        |         |
| MAC Address   | IP Address | Enable | Actions |

When **Add** button is applied, **Mapping Rule Configuration** screen will appear.

| <input type="checkbox"/> Mapping Rule Configuration |                                 |
|---|---------------------------------|
| Item  | Setting                         |
| ▶ MAC Address                                       | <input type="text"/>            |
| ▶ IP Address  | <input type="text"/>            |
| ▶ Rule  | <input type="checkbox"/> Enable |

| Mapping Rule Configuration |  |   |
|----------------------------|--|---|
| Item                       | Value setting  | Description   |
| <b>MAC Address</b>         | 1. MAC Address string format<br>2. A Must filled setting | The MAC Address of this mapping rule.   |
| <b>IP Address</b>          | 1. IPv4 format.<br>2. A Must filled setting              | The IP Address of this mapping rule.  |
| <b>Rule</b>                | The box is unchecked by default.                         | Click <b>Enable</b> box to activate this rule.  |
| <b>Save</b>                | N/A  | Click the <b>Save</b> button to save the configuration  |
| <b>Undo</b>                | N/A  | Click the <b>Undo</b> button to restore what you just configured back to the previous setting.              |
| <b>Back</b>                | N/A  | When the <b>Back</b> button is clicked the screen will return to the <b>DHCP Server Configuration</b> page. |

### View / Copy DHCP Client List

When **DHCP Client List** button is applied, **DHCP Client List** screen will appear.

| DHCP Client List <input type="button" value="Copy to Fixed Mapping"/> |                          |           |                   |                      |                                 |
|---|--------------------------|-----------|-------------------|----------------------|---------------------------------|
| LAN Interface   | IP Address               | Host Name | MAC Address       | Remaining Lease Time | Actions                         |
| Ethernet  | Dynamic /192.168.123.222 | UPER-NB   | 50:7B:9D:A6:53:4B | 23:56:27             | <input type="checkbox"/> Select |

When the DHCP Client is selected and **Copy to Fixed Mapping** button is applied. The IP and MAC address of DHCP Client will apply to the Mapping Rule List on specific DHCP Server automatically.

### Enable / Disable DHCP Server Options

The **DHCP Server Options** setting allows user to set **DHCP OPTIONS 66, 72, or 114**. Click the **Enable** button to activate the DHCP option function, and the DHCP Server will add the expected options in its sending out DHCPOFFER DHCPACK packages.

| Option | Meaning                       | RFC                        |
|--------|-------------------------------|----------------------------|
| 66     | TFTP server name              | <a href="#">[RFC 2132]</a> |
| 72     | Default World Wide Web Server | <a href="#">[RFC 2132]</a> |
| 114    | URL                           | <a href="#">[RFC 3679]</a> |

| Configuration         |                                 |
|-----------------------|---------------------------------|
| Item                  | Setting                         |
| ▶ DHCP Server Options | <input type="checkbox"/> Enable |

### Create / Edit DHCP Server Options

The router supports up to a maximum of 99 option settings.

| DHCP Server Option List <input type="button" value="Add"/> <input type="button" value="Delete"/> |             |                   |               |      |       |        |         |
|--|-------------|-------------------|---------------|------|-------|--------|---------|
| ID   | Option Name | DHCP Sever Select | Option Select | Type | Value | Enable | Actions |

When **Add/Edit** button is applied, **DHCP Server Option Configuration** screen will appear.

DHCP Server Option Configuration

| Item              | Setting  |
|-------------------|--|
| Option Name       | <input type="text" value="Option 1"/>            |
| DHCP Sever Select | <input type="button" value="DHCP 1"/>            |
| Option Select     | <input type="button" value="DHCP OPTION 66"/>    |
| Type              | <input type="button" value="Single IP Address"/> |
| Value             | <input type="text"/>                             |
| Enable            | <input type="checkbox"/> Enable                  |

| DHCP Server Option Configuration |   |  |                                     |                               |
|----------------------------------|---|--|-------------------------------------|-------------------------------|
| Item                             | Value setting   | Description  |                                     |                               |
| <b>Option Name</b>               | 1. String format can be any text<br>2. A Must filled setting.                               | Enter a DHCP Server Option name. Enter a name that is easy for you to understand.  |                                     |                               |
| <b>DHCP Server Select</b>        | Dropdown list of all available DHCP servers.  | Choose the DHCP server this option should apply to.  |                                     |                               |
| <b>Option Select</b>             | 1. A Must filled setting.<br>2. <b>Option 66</b> is selected by default.                    | Choose the specific option from the dropdown list. It can be <b>Option 66, Option 72, Option 144, Option 42, Option 150, or Option 160.</b><br><b>Option 42</b> for ntp server;<br><b>Option 66</b> for tftp;<br><b>Option 72</b> for www;<br><b>Option 144</b> for url; |                                     |                               |
| <b>Type</b>                      | Dropdown list of DHCP server option value's type  | Each different options has different value types.  |                                     |                               |
|                                  |   | 66      Single IP Address  |                                     |                               |
|                                  |   | Single FQDN  |                                     |                               |
|                                  |   | 72      IP Addresses List, separated by “,”  |                                     |                               |
|                                  |   | 114     Single URL   |                                     |                               |
|                                  |   | 42      IP Addresses List, separated by “,”  |                                     |                               |
|                                  |   | 150     IP Addresses List, separated by “,”  |                                     |                               |
| <b>Value</b>                     | 1. IPv4 format<br>2. FQDN format<br>3. IP list<br>4. URL format<br>5. A Must filled setting | Should conform to Type :   |                                     |                               |
|                                  |   |  | Type                                | Value                         |
|                                  |   | 66   | Single IP Address                   | IPv4 format                   |
|                                  |   |  | Single FQDN                         | FQDN format                   |
|                                  |   | 72   | IP Addresses List, separated by “,” | IPv4 format, separated by “,” |
| 114                              | Single URL  | URL format   |                                     |                               |
| <b>Enable</b>                    | The box is unchecked by default.  | Click <b>Enable</b> box to activate this setting.  |                                     |                               |
| <b>Save</b>                      | NA  | Click the <b>Save</b> button to save the setting.  |                                     |                               |
| <b>Undo</b>                      | NA  | When the <b>Undo</b> button is clicked the screen will return back with nothing changed.   |                                     |                               |



## Create / Edit DHCP Relay

The router supports up to a maximum of 6 DHCP Relay configurations.

| DHCP Relay Configuration List <input type="button" value="Add"/> <input type="button" value="Delete"/> |            |               |               |           |        |         |
|--|------------|---------------|---------------|-----------|--------|---------|
| ID   | Agent Name | LAN interface | WAN interface | Server IP | Enable | Actions |

When **Add/Edit** button is applied, **DHCP Relay Configuration** screen will appear.

| DHCP Relay Configuration <input type="button" value="Save"/> <input type="button" value="Undo"/> |                          |
|--|--------------------------|
| Item   | Setting                  |
| Agent Name   | <input type="text"/>     |
| LAN interface  | LAN ▾                    |
| WAN interface  | WAN - 1 ▾                |
| Server IP  | <input type="text"/>     |
| Enable   | <input type="checkbox"/> |

| DHCP Relay Configuration |  |  |
|--------------------------|--|--|
| Item                     | Value setting  | Description  |
| <b>Agent Name</b>        | 1. String format can be any text<br>2. A Must filled setting.        | Enter a DHCP Relay name. Enter a name that is easy for you to understand.<br><b>Value Range:</b> 1~64 characters.                                  |
| <b>LAN Interface</b>     | 1. A Must filled setting.<br>2. <b>LAN</b> is selected by default.   | Choose a LAN Interface for the dropdown list to apply with the DHCP Relay function.  |
| <b>WAN Interface</b>     | 1. A Must filled setting.<br>2. <b>WAN-1</b> is selected by default. | Choose a WAN Interface for the dropdown list to apply with the DHCP Relay function. It can be the available WAN interface(s), and L2TP connection. |
| <b>Server IP</b>         | 1. A Must filled setting.<br>2. <b>null</b> by default.              | Assign a <b>DHCP Server IP Address</b> that the gateway will relay the DHCP requests to the assigned DHCP server via specified WAN interface.      |
| <b>Enable</b>            | The box is unchecked by default.                                     | Click <b>Enable</b> box to activate this setting.  |
| <b>Save</b>              | NA   | Click the <b>Save</b> button to save the setting.  |
| <b>Undo</b>              | NA   | When the <b>Undo</b> button is clicked the screen will return back with nothing changed.   |

## 2.3 WiFi

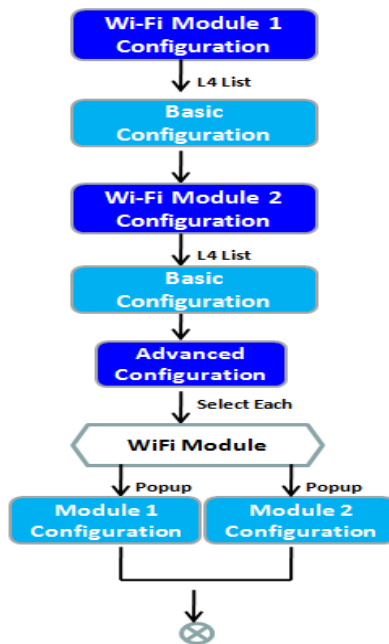

| Basic Configuration [ Help ]   |  |      |                |            |               |                |        |         |
|--|--|------|----------------|------------|---------------|----------------|--------|---------|
| Item   | Setting                                    |      |                |            |               |                |        |         |
| ▶ Operation Band   | 2.4G Single Band                           |      |                |            |               |                |        |         |
| 2.4G WiFi Configuration  |  |      |                |            |               |                |        |         |
| Item   | Setting                                    |      |                |            |               |                |        |         |
| ▶ WiFi Module  | <input checked="" type="checkbox"/> Enable |      |                |            |               |                |        |         |
| ▶ Channel  | 12   |      |                |            |               |                |        |         |
| ▶ WiFi System  | 802.11b/g/n Mixed                          |      |                |            |               |                |        |         |
| ▶ WiFi Operation Mode  | AP Router Mode                             |      |                |            |               |                |        |         |
| ▶ Green AP   | <input type="checkbox"/> Enable            |      |                |            |               |                |        |         |
| ▶ VAP Isolation  | <input checked="" type="checkbox"/> Enable |      |                |            |               |                |        |         |
| ▶ Time Schedule  | (0) Always                                 |      |                |            |               |                |        |         |
| 2.4G VAP List <input type="button" value="Add"/> <input type="button" value="Delete"/> |  |      |                |            |               |                |        |         |
| ID   | VAP  | SSID | Authentication | Encryption | STA Isolation | Broadcast SSID | Enable | Actions |

The router provides WiFi interface for mobile devices or BYOD devices to connect for Internet/Intranet accessing. WiFi function is usually modularized design in a router, and there can be single or dual modules within a router. The WiFi system in the router complies with IEEE 802.11n/11g/11b standard in 2.4GHz single band. There are several wireless operation modes provided by this device. They are: “**AP Router Mode**”, “**WDS Only Mode**”, and “**WDS Hybrid Mode**”. You can choose the expected mode from the wireless operation mode list.

There are some sub-sections for you to configure the WiFi function, including “Basic Configuration” and “Advanced Configuration”. In Basic Configuration section, you have to finish almost all the settings for using the WiFi function. And the Advanced Configuration section provides more parameters for advanced user to fine tune the connectivity performance for the WiFi function.

### 2.3.1 WiFi Configuration

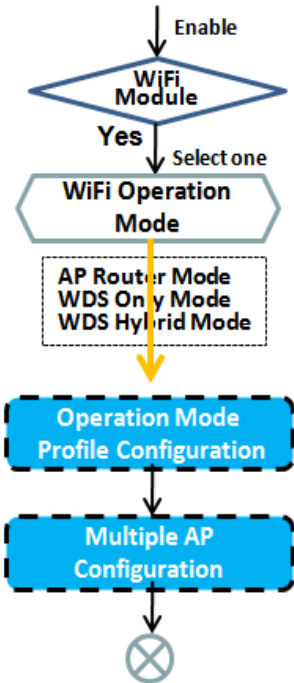

2.4G WiFi Configuration

| Item                | Setting                                    |
|---------------------|--|
| WiFi Module         | <input checked="" type="checkbox"/> Enable |
| Channel             | 12   |
| WiFi System         | 802.11b/g/n Mixed                          |
| WiFi Operation Mode | AP Router Mode                             |
| Green AP            | <input type="checkbox"/> Enable            |
| VAP Isolation       | <input checked="" type="checkbox"/> Enable |
| Time Schedule       | (0) Always                                 |

2.4G VAP List Add Delete

| ID | VAP   | SSID       | Authentication | Encryption | STA Isolation            | Broadcast SSID                      | Enable                              | Actions  |
|----|-------|------------|----------------|------------|--------------------------|-------------------------------------|-------------------------------------|--|
| 1  | VAP 1 | Staff_2.4G | Open           | None       | <input type="checkbox"/> | <input checked="" type="checkbox"/> | <input checked="" type="checkbox"/> | <span>Edit</span> <input type="checkbox"/> <span>Select</span> |

VAP Configuration

| Item           | Setting                             |
|----------------|-------------------------------------|
| VAP            | VAP1                                |
| SSID           | Staff_2.4G                          |
| Max. STA       | <input type="checkbox"/> Enable     |
| Authentication | WPA2-PSK                            |
| Encryption     | AES                                 |
| Preshared Key  | 1234567890                          |
| STA Isolation  | <input checked="" type="checkbox"/> |
| Broadcast SSID | <input checked="" type="checkbox"/> |
| Enable         | <input checked="" type="checkbox"/> |

Due to optional module(s) and frequency band, you need to setup module one by one. For each module, you need to specify the operation mode, and then setup the virtual APs for wireless access.

Hereunder are the scenarios for each wireless operation mode, you can get how it works, and what is the difference among them. To connect your wireless devices with the wireless gateway, make sure your application scenario for WiFi network and choose the most adequate operation mode.

### AP Router Mode

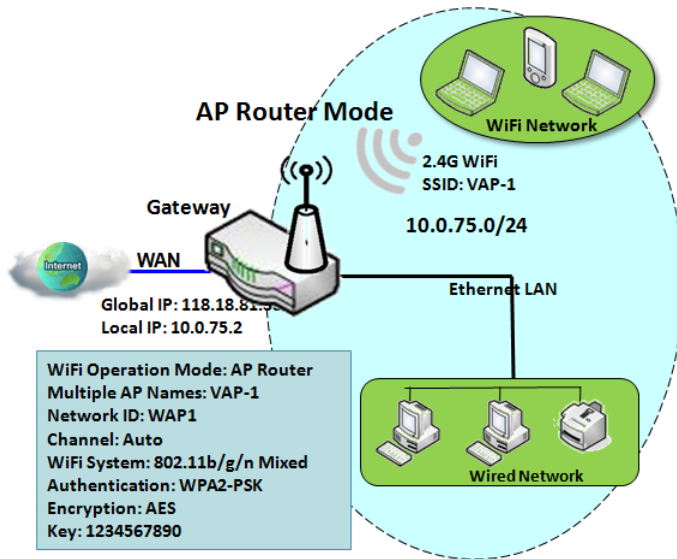

This mode allows you to get your wired and wireless devices connected to form the Intranet of the wireless gateway, and the Intranet will link to the Internet with NAT mechanism of the router. So, this router is working as a WiFi AP, but also a WiFi hotspot for Internet accessing service. It means local WiFi clients can associate to it, and go to Internet. With its NAT mechanism, all of wireless clients don't need to get public IP addresses from ISP.

### WDS Only Mode

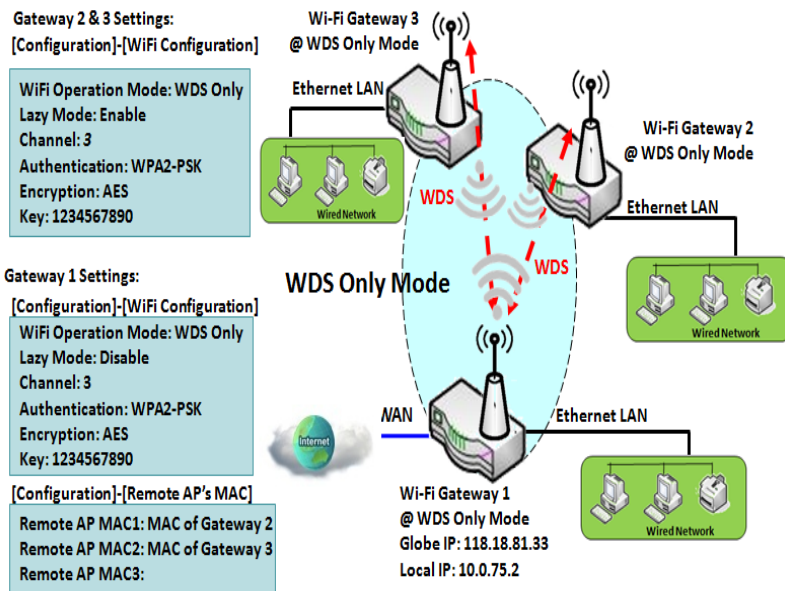

WDS (Wireless Distributed System) Only mode drives a WiFi gateway to be a bridge for its wired Intranet and a repeater to extend distance. You can use multiple WiFi gateways as a WiFi repeater chain with all gateways setup as "WDS Only" mode. All gateways can communicate with each other through WiFi. All wired client hosts within each gateway can also communicate each other in the scenario. Only one gateway within repeater chain can be DHCP server to provide IP for all wired client hosts of every gateway which being disabled DHCP server. This router can be NAT router to provide internet access.

The diagram illustrates that there are two wireless gateways 2, 3 running at "WDS Only" mode. They both use channel 3 to link to local Gateway 1 through WDS. Both gateways connected by WDS need to setup the remote AP MAC for each other. All client hosts under gateway 2, 3 can request IP address from the DHCP server at gateway 1. Besides, wireless Gateway 1 also execute the NAT mechanism for all client hosts Internet accessing.

### WDS Hybrid Mode

Gateway 2 / AP 1 Settings:  
[Configuration]-[WiFi Configuration]

WiFi Operation Mode: WDS Hybrid  
 Lazy Mode: Enable  
 Multiple AP Names: VAP1  
 Network ID: Extended-WiFi  
 Channel: same as Router 1  
 Authentication: same as Router 1  
 Encryption: same as Router 1  
 Key: same as Router 1

Gateway 1 Settings:  
[Configuration]-[WiFi Configuration]

WiFi Operation Mode: WDS Hybrid  
 Lazy Mode: Disable  
 Multiple AP Names: VAP1  
 Network ID: Extended-WiFi  
 Channel: 3  
 Authentication: WPA2-PSK  
 Encryption: AES  
 Key: 1234567890

[Configuration]-[Remote AP's MAC]

Remote AP MAC1: MAC of Router 2  
 Remote AP MAC2: MAC of AP 1  
 Remote AP MAC3:

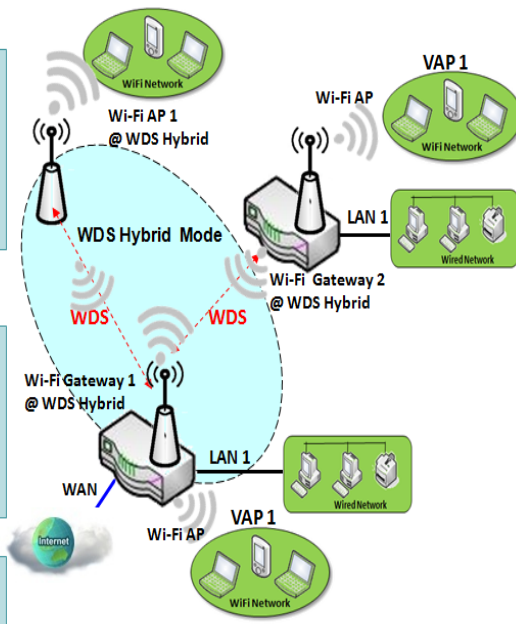

WDS hybrid mode includes both WDS and AP Router mode. WDS Hybrid mode can act as an access point for its WiFi Intranet and a WiFi bridge for its wired and WiFi Intranets at the same time. Users can thus use the features to build up a large wireless network in a large space like airports, hotels or campus.

The diagram illustrates Gateway 1, Gateway 2 and AP 1 connected by WDS. Each gateway has access point function for WiFi client access. Gateway 1 has DHCP server to assign IP to each client hosts. All gateways and AP are under WDS hybrid mode. To setup WDS hybrid mode, it need to fill all configuration items similar to that of AP-router and WDS modes.

### Multiple VAPs

Gateway Settings:

WiFi Operation Mode: AP Router  
 VAP1  
 SSID: VAP-1  
 Authentication: WPA2-PSK  
 Encryption: TKIP  
 Key: 1234567890  
 VAP2  
 SSID: VAP-2  
 Authentication: WPA2-PSK  
 Encryption: TKIP  
 Key: 1234567890  
 VAP3  
 SSID: VAP-3  
 Authentication: WPA2  
 Encryption: TKIP  
 RADIUS Server IP: 192.168.168.  
 RADIUS Server Port: 1812  
 RADIUS Shared Key

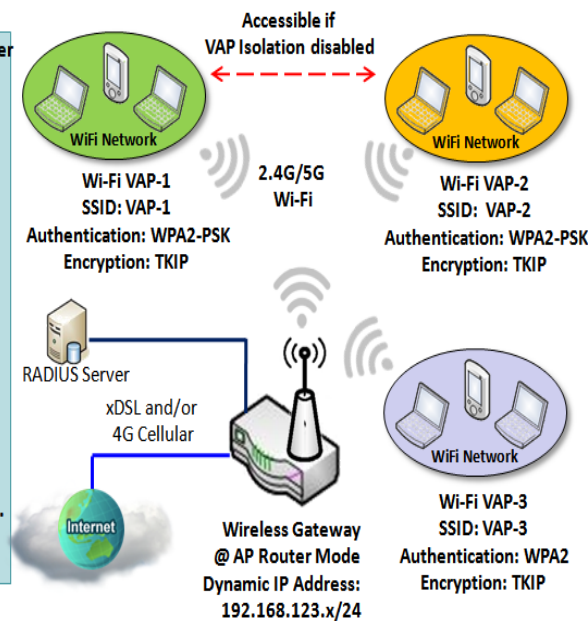

VAP (Virtual Access Point) is function to partition wireless network into multiple broadcast domains. It can simulate multiple APs in one physical AP. This wireless gateway supports up to 2 VAPs. For each VAP, you need to setup SSID, authentication and encryption to control Wi-Fi client access.

Besides, there is a VAP isolation option to manage the access among VAPs. You can allow or blocks communication for the wireless clients connected to different VAPs. As shown in the diagram, the clients in VAP-1 and VAP-2 can communicate to each other when VAP Isolation is disabled.

## Wi-Fi Security – Authentication & Encryption

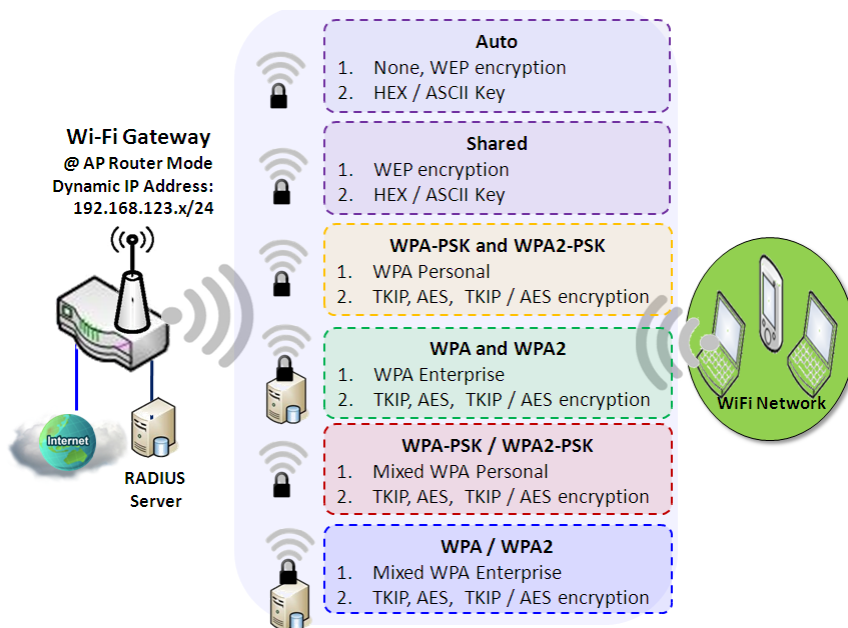

Wi-Fi security provides complete authentication and encryption mechanisms to enhance the data security while your data is transferred wirelessly over the air. The wireless gateway supports Shared, WPA-PSK / WPA2-PSK and WPA / WPA2 authentication. You can select one authentication scheme to validate the wireless clients while they are connecting to the AP. As to the data encryption, the router supports WEP, TKIP and AES. The selected encryption algorithm will be applied to the data while the wireless connection is established.

## WiFi Configuration Setting

The WiFi configuration allows user to configure 2.4GHz WiFi settings.

Go to **Basic Network > WiFi > WiFi Module One** Tab.

If the gateway is equipped with two WiFi modules, there will be another **WiFi Module Two**. You can do the similar configurations on both WiFi modules.

## Basic Configuration

| Basic Configuration [ Help ] |                    |
|------------------------------|--------------------|
| Item                         | Setting            |
| ▶ Operation Band             | 2.4G Single Band ▼ |

| Basic Configuration |                       |   |
|---------------------|-----------------------|---|
| Item                | Value setting         | Description   |
| Operation Band      | A Must filled setting | Specify the intended operation band for the WiFi module. Basically, this setting is fixed and cannot be changed once the module is integrated into the product. However, there is some module with selectable band for user to choose according to his network environment. Under such situation, you can specify which operation band is suitable for the application. |

## Configure WiFi Setting

| 2.4G WiFi Configuration |  |
|-------------------------|--|
| Item                    | Setting                                    |
| ▶ WiFi Module           | <input checked="" type="checkbox"/> Enable |
| ▶ Channel               | 12 ▾                                       |
| ▶ WiFi System           | 802.11b/g/n Mixed ▾                        |
| ▶ WiFi Operation Mode   | AP Router Mode ▾                           |

### Configuring Wi-Fi Settings

| Item                | Value setting   | Description   |
|---------------------|---|---|
| WiFi Module         | The box is checked by default                                       | Check the <b>Enable</b> box to activate Wi-Fi function.   |
| Channel             | 1. A Must filled setting.<br>2. <b>Auto</b> is selected be default. | Select a radio channel for the VAP. Each channel is corresponding to different radio band. The permissible channels depend on the <b>Regulatory Domain</b> .<br>There are two available options when <b>Auto</b> is selected: <ul style="list-style-type: none"> <li>● <b>By AP Numbers</b><br/>The channel will be selected according to AP numbers (The less, the better).</li> <li>● <b>By Less Interference</b><br/>The channel will be selected according to interference. (The lower, the better).</li> </ul> |
| WiFi System         | A Must filled setting   | Specify the preferred WiFi System. The dropdown list of <b>WiFi system</b> is based on <b>IEEE 802.11</b> standard. <ul style="list-style-type: none"> <li>● <b>2.4G WiFi</b> can select b, g and n only or mixed with each other.</li> </ul>   |
| WiFi Operation Mode |   | Specify the <b>WiFi Operation Mode</b> according to your application. Go to the following table for <b>AP Router Mode</b> , <b>WDS Only Mode</b> , and <b>WDS Hybrid Mode</b> settings.<br><br>Note: The available operation modes depend on the product specification.   |

In the following, the specific configuration description for each WiFi operation mode is given.

### AP Router Mode & VAPs Configuration

For the AP Router mode, the device not only supports **stations connection** but also the **router function**. The **WAN** port and the **NAT** function are **enabled**.

|                       |  |
|-----------------------|--|
| ▶ WiFi Operation Mode | AP Router Mode ▾                           |
| ▶ Green AP            | <input type="checkbox"/> Enable            |
| ▶ VAP Isolation       | <input checked="" type="checkbox"/> Enable |
| ▶ Time Schedule       | (0) Always ▾                               |

| AP Router Mode |                                  |  |
|----------------|----------------------------------|--|
| Item           | Value setting                    | Description  |
| Green AP       | The box is unchecked by default. | Check the <b>Enable</b> box to activate <b>Green AP</b> function.  |
| VAP Isolation  | The box is checked by default.   | Check the <b>Enable</b> box to activate this function. By default, the box is checked; it means that stations which associated to different VAPs cannot communicate with each other.   |
| Time Schedule  | A Must filled setting            | Apply a specific <b>Time Schedule</b> to this rule; otherwise leave it as <b>(0) Always</b> . If the dropdown list is empty ensure <b>Time Schedule</b> is pre-configured. Refer to <b>Object Definition &gt; Scheduling &gt; Configuration</b> tab. |

| 2.4G VAP List <input type="button" value="Add"/> <input type="button" value="Delete"/> |       |            |                |            |                          |                                     |                                     |   |
|--|-------|------------|----------------|------------|--------------------------|-------------------------------------|-------------------------------------|---|
| ID   | VAP   | SSID       | Authentication | Encryption | STA Isolation            | Broadcast SSID                      | Enable                              | Actions   |
| 1  | VAP 1 | Staff_2.4G | Open           | None       | <input type="checkbox"/> | <input checked="" type="checkbox"/> | <input checked="" type="checkbox"/> | <input type="button" value="Edit"/> <input type="checkbox"/> Select |

By default, VAP 1 is enabled and security key is required to connect to the gateway wirelessly to enhance the security level and prevent unexpected access of un-authorized devices.

**The default WiFi key is printed on both the device label and the Security Card. It is created randomly and differs from devices. So, you can connected to the VAP1 (SSID: Staff\_2.4G) with the provided key.**

**However, it is strongly recommended that you have to change the security key to easy-to-remember one by clicking the Edit button.**

Click **Add / Edit** button in the VAP List screen to create or edit the settings for a VAP. A VAP Configuration screen will appear.

For VAP 1:

| VAP Configuration |   |
|-------------------|---|
| Item              | Setting                                       |
| ▶ VAP             | VAP1 ▾  |
| ▶ SSID            | Staff_2.4G                                    |
| ▶ Max. STA        | <input type="checkbox"/> Enable               |
| ▶ Authentication  | Open ▾ 802.1x <input type="checkbox"/> Enable |
| ▶ Encryption      | None ▾  |
| ▶ STA Isolation   | <input type="checkbox"/>                      |
| ▶ Broadcast SSID  | <input checked="" type="checkbox"/>           |
| ▶ Enable          | <input checked="" type="checkbox"/>           |



For others:

| VAP Configuration |   |
|-------------------|---|
| Item              | Setting                                       |
| ▶ VAP             | VAP2 ▾  |
| ▶ SSID            | default                                       |
| ▶ Max. STA        | <input type="checkbox"/> Enable               |
| ▶ Authentication  | Open ▾ 802.1x <input type="checkbox"/> Enable |
| ▶ Encryption      | None ▾  |
| ▶ STA Isolation   | <input type="checkbox"/>                      |
| ▶ Broadcast SSID  | <input type="checkbox"/>                      |
| ▶ Enable          | <input type="checkbox"/>                      |

| VAP Configuration |   |  |
|-------------------|---|--|
| Item              | Value setting   | Description  |
| SSID              | 1. String format : Any text   | Enter the SSID for the VAP, and decide whether to broadcast the SSID or not. The <b>SSID</b> is used for identifying from another AP, and client stations will associate with AP according to SSID.  |
| Max. STA          | The box is unchecked by default.  | Check this box and enter a limitation to limit the maximum number of client station.<br>The box is unchecked by default. It means no special limitation on the number of connected STAs.   |
| Authentication    | 1. A Must filled setting<br>2. VAP1: <b>WPA2-PSK</b> is selected be default;<br>Others: <b>Open</b> is selected be default. | <p>For security, there are several authentication methods supported. Client stations should provide the key when associate with this device.</p> <p>When <b>Open</b> is selected<br/>The check box named <b>802.1x</b> shows up next to the dropdown list.</p> <ul style="list-style-type: none"> <li>● <b>802.1x</b> (The box is unchecked by default)<br/>When <b>802.1x</b> is enabled, it means the client stations will be authenticated by RADIUS server.<br/><b>RADIUS Server IP</b> (The default IP is 0.0.0.0)<br/><b>RADIUS Server Port</b> (The default value is 1812)<br/><b>RADIUS Shared Key</b></li> </ul> <p>When <b>Shared</b> is selected<br/>The pre-shared WEP key should be set for authenticating.</p> <p>When <b>Auto</b> is selected<br/>The device will select <b>Open</b> or <b>Shared</b> by requesting of client automatically.<br/>The check box named <b>802.1x</b> shows up next to the dropdown list.</p> <ul style="list-style-type: none"> <li>● <b>802.1x</b> (The box is unchecked by default)<br/>When <b>802.1x</b> is enabled, it means the client stations will be authenticated by RADIUS server.<br/><b>RADIUS Server IP</b> (The default IP is 0.0.0.0)<br/><b>RADIUS Server Port</b> (The default value is 1812)<br/><b>RADIUS Shared Key</b></li> </ul> |

|                       |  |  |
|-----------------------|--|--|
|                       |  | <p>When <b>WPA</b> or <b>WPA2</b> is selected<br/>They are implementation of IEEE 802.11i. <b>WPA</b> only had implemented part of IEEE 802.11i, but owns the better <b>compatibility</b>.<br/><b>WPA2</b> had fully implemented 802.11i standard, and owns the highest <b>security</b>.</p> <ul style="list-style-type: none"> <li>● <b>RADIUS Server</b><br/>The client stations will be authenticated by RADIUS server.<br/><b>RADIUS Server IP</b> (The default IP is 0.0.0.0)<br/><b>RADIUS Server Port</b> (The default value is 1812)<br/><b>RADIUS Shared Key</b></li> </ul> <p>When <b>WPA / WPA2</b> is selected<br/>It owns the same setting as <b>WPA</b> or <b>WPA2</b>. The client stations can associate with this device via <b>WPA</b> or <b>WPA2</b>.</p> <p>When <b>WPA-PSK</b> or <b>WPA2-PSK</b> is selected<br/>It owns the same encryption system as WPA or WPA2. The authentication uses pre-shared key instead of RADIUS server.</p> <p>When <b>WPA-PSK / WPA2-PSK</b> is selected<br/>It owns the same setting as <b>WPA-PSK</b> or <b>WPA2-PSK</b>. The client stations can associate with this device via <b>WPA-PSK</b> or <b>WPA2-PSK</b>.</p>   |
| <b>Encryption</b>     | <p>1. A Must filled setting.<br/>2. VAP1: <b>AES</b> is selected be default;<br/>Others: <b>None</b> is selected be default.</p> | <p>Select a suitable encryption method and enter the required key(s).<br/>The available method in the dropdown list depends on the Authentication you selected.</p> <p><b>None</b><br/>It means that the device is open system without encrypting.</p> <p><b>WEP</b><br/>Up to 4 WEP keys can be set, and you have to select one as current key. The key type can set to <b>HEX</b> or <b>ASCII</b>.<br/>If <b>HEX</b> is selected, the key should consist of (0 to 9) and (A to F).<br/>If <b>ASCII</b> is selected, the key should consist of ASCII table.</p> <p><b>TKIP</b><br/>TKIP was proposed instead of WEP without upgrading hardware. Enter a Pre-shared Key for it. The length of key is from 8 to 63 characters.</p> <p><b>AES</b><br/>The newest encryption system in WiFi, it also designed for the fast 802.11n high bitrates schemes. Enter a Pre-shared Key for it. The length of key is from 8 to 63 characters.<br/>You are recommended to use <b>AES</b> encryption instead of any others for security.</p> <p><b>TKIP / AES</b><br/><b>TKIP / AES</b> mixed mode. It means that the client stations can associate with this device via <b>TKIP</b> or <b>AES</b>. Enter a Pre-shared Key for it. The length of key is from 8 to 63 characters.</p> |
| <b>STA Isolation</b>  | <p>VAP1: The box is checked by default;<br/>Others: unchecked by default.</p>  | <p>Check the <b>Enable</b> box to activate this function.<br/>By default, the box is checked; it means that stations which associated to the same VAP cannot communicate with each other.</p>  |
| <b>Broadcast SSID</b> | <p>VAP1: The box is checked by default;<br/>Others: unchecked by default.</p>  | <p>Check the <b>Enable</b> box to activate this function.<br/>If the broadcast SSID option is enabled, it means the SSID will be broadcasted, and the stations can associate with this device by scanning SSID.</p>  |
| <b>Enable</b>         | <p>VAP1: The box is checked by default;<br/>Others: unchecked by default.</p>  | <p>Check the <b>Enable</b> box to activate this VAP.</p>   |

|              |     |  |
|--------------|-----|--|
| <b>Save</b>  | N/A | Click the <b>Save</b> button to save the current configuration.                          |
| <b>Undo</b>  | N/A | Click the <b>Undo</b> button to restore configuration to previous setting before saving. |
| <b>Apply</b> | N/A | Click the <b>Apply</b> button to apply the saved configuration.                          |

## WDS Only Mode

For the WDS Only mode, the device only bridges the connected wired clients to another WDS-enabled WiFi device which the device associated with. That is, it also means the no wireless clients stat can connect to this device while WDS Only Mode is selected.

|                             |                                     |
|-----------------------------|-------------------------------------|
| ▶ WiFi Operation Mode       | WDS Only Mode ▾                     |
| ▶ Green AP                  | <input type="checkbox"/> Enable     |
| ▶ Time Schedule             | (0) Always ▾                        |
| ▶ Scan Remote AP's MAC List | <input type="button" value="Scan"/> |
| Remote AP MAC 1             | <input type="text"/>                |
| Remote AP MAC 2             | <input type="text"/>                |
| Remote AP MAC 3             | <input type="text"/>                |
| Remote AP MAC 4             | <input type="text"/>                |

| WDS Only Mode                    |                                  |  |
|----------------------------------|----------------------------------|--|
| Item                             | Value setting                    | Description  |
| <b>Green AP</b>                  | The box is unchecked by default. | Check the <b>Enable</b> box to activate <b>Green AP</b> function.  |
| <b>Time Schedule</b>             | A Must filled setting            | Apply a specific <b>Time Schedule</b> to this rule; otherwise leave it as <b>(0) Always</b> . If the dropdown list is empty ensure <b>Time Schedule</b> is pre-configured. Refer to <b>Object Definition &gt; Scheduling &gt; Configuration</b> tab. |
| <b>Scan Remote AP's MAC List</b> | N/A                              | Press the <b>Scan</b> button to scan the spatial AP information, and then select one from the AP list, the MAC of selected AP will be auto filled in the following Remote AP MAC table.  |
| <b>Remote AP MAC 1~4</b>         | A Must filled setting            | Enter the remote AP's MAC manually, or via auto-scan approach, The device will bridge the traffic to the remote AP when associated successfully.   |

| 2.4G VAP List <input type="button" value="Add"/> <input type="button" value="Delete"/> |       |            |                |            |                                     |                                     |                                     |   |
|--|-------|------------|----------------|------------|-------------------------------------|-------------------------------------|-------------------------------------|---|
| ID   | VAP   | SSID       | Authentication | Encryption | STA Isolation                       | Broadcast SSID                      | Enable                              | Actions   |
| 1  | VAP 1 | Staff_2.4G | WPA2-PSK       | AES        | <input checked="" type="checkbox"/> | <input checked="" type="checkbox"/> | <input checked="" type="checkbox"/> | <input type="button" value="Edit"/> <input type="checkbox"/> Select |

By default, VAP 1 is enabled and security key is required to connect to the gateway wirelessly to enhance the security level and prevent unexpected access of un-authorized devices.

The default WiFi key is printed on both the device label and the Security Card. It is created randomly and differs from devices. So, you can connected to the VAP1 (SSID: Staff\_2.4G) with the provided key.

However, it is strongly recommended that you have to change the security key to an easy-to-remember one by clicking the Edit button.

Under **WDS Only** mode, only VAP1 is available for further specifying the required authentication and Encryption settings. Click **Edit** button in the VAP List screen and a VAP Configuration screen will appear for you to configure the required settings

| VAP Configuration |                                     |
|-------------------|-------------------------------------|
| Item              | Setting                             |
| ▶ VAP             | VAP1 ▾                              |
| ▶ SSID            | Staff_2.4G                          |
| ▶ Max. STA        | <input type="checkbox"/> Enable     |
| ▶ Authentication  | WPA2-PSK ▾                          |
| ▶ Encryption      | AES ▾                               |
| ▶ Preshared Key   | 1234567890                          |
| ▶ STA Isolation   | <input checked="" type="checkbox"/> |
| ▶ Broadcast SSID  | <input checked="" type="checkbox"/> |
| ▶ Enable          | <input checked="" type="checkbox"/> |

For the detail description about VAP configuration, please refer to the description stated in AP-Router section.

## WDS Hybrid Mode

For the WDS Hybrid mode, the device bridges all the wired **LAN** and **WLAN** clients to another WDS or WDS hybrid enabled WiFi devices which the device associated with.

|                             |  |
|-----------------------------|--|
| ▶ WiFi Operation Mode       | WDS Hybrid Mode ▾                          |
| ▶ Lazy Mode                 | <input type="checkbox"/> Enable            |
| ▶ Green AP                  | <input type="checkbox"/> Enable            |
| ▶ VAP Isolation             | <input checked="" type="checkbox"/> Enable |
| ▶ Time Schedule             | (0) Always ▾                               |
| ▶ Scan Remote AP's MAC List | <input type="button" value="Scan"/>        |
| Remote AP MAC 1             | <input type="text"/>                       |
| Remote AP MAC 2             | <input type="text"/>                       |
| Remote AP MAC 3             | <input type="text"/>                       |
| Remote AP MAC 4             | <input type="text"/>                       |

### WDS Hybrid Mode

| Item                             | Value setting                      | Description  |
|----------------------------------|------------------------------------|--|
| <b>Lazy Mode</b>                 | The box is checked by default.     | Check the <b>Enable</b> box to activate this function. With the function been enabled, the device can auto-learn WDS peers without manually entering other AP's MAC address. But at least one of the APs has to fill remote AP MAC addresses.        |
| <b>Green AP</b>                  | The box is unchecked by default.   | Check the <b>Enable</b> box to activate <b>Green AP</b> function.  |
| <b>VAP Isolation</b>             | The box is checked by default.     | Check the <b>Enable</b> box to activate this function. By default, the box is checked; it means that stations which associated to different VAPs cannot communicate with each other.   |
| <b>Time Schedule</b>             | A Must filled setting              | Apply a specific <b>Time Schedule</b> to this rule; otherwise leave it as <b>(0) Always</b> . If the dropdown list is empty ensure <b>Time Schedule</b> is pre-configured. Refer to <b>Object Definition &gt; Scheduling &gt; Configuration</b> tab. |
| <b>Scan Remote AP's MAC List</b> | Available when Lazy Mode disabled. | Press the <b>Scan</b> button to scan the spatial AP information, and then select one from the AP list, the MAC of selected AP will be auto filled in the following Remote AP MAC table.  |
| <b>Remote AP MAC 1~4</b>         | Available when Lazy Mode disabled. | Enter the remote AP's MAC manually, or via auto-scan approach, The device will bridge the traffic to the remote AP when associated successfully.   |

| <input type="checkbox"/> 2.4G VAP List <input type="button" value="Add"/> <input type="button" value="Delete"/> |       |            |                |            |                                     |                                     |                                     |   |
|---|-------|------------|----------------|------------|-------------------------------------|-------------------------------------|-------------------------------------|---|
| ID  | VAP   | SSID       | Authentication | Encryption | STA Isolation                       | Broadcast SSID                      | Enable                              | Actions   |
| 1   | VAP 1 | Staff_2.4G | WPA2-PSK       | AES        | <input checked="" type="checkbox"/> | <input checked="" type="checkbox"/> | <input checked="" type="checkbox"/> | <input type="button" value="Edit"/> <input type="checkbox"/> Select |

By default, VAP 1 is enabled and security key is required to connect to the gateway wirelessly to enhance the security level and prevent unexpected access of un-authorized devices.

The default WiFi key is printed on both the device label and the Security Card. It is created randomly and differs from devices. So, you can connected to the VAP1 (SSID: Staff\_2.4G) with the provided key.

However, it is strongly recommended that you have to change the security key to an easy-to-remember one by clicking the Edit button.

Under **WDS Hybrid** mode, the VAP function is available and you can further specifying the required VAP settings for connecting with wireless client devices.

Click **Add / Edit** button in the VAP List screen to create or edit the settings for a VAP. A VAP Configuration screen will appear.

For VAP 1:

| VAP Configuration |                                     |
|-------------------|-------------------------------------|
| Item              | Setting                             |
| ▶ VAP             | VAP1 ▾                              |
| ▶ SSID            | Staff_2.4G                          |
| ▶ Max. STA        | <input type="checkbox"/> Enable     |
| ▶ Authentication  | WPA2-PSK ▾                          |
| ▶ Encryption      | AES ▾                               |
| ▶ Preshared Key   | 1234567890                          |
| ▶ STA Isolation   | <input checked="" type="checkbox"/> |
| ▶ Broadcast SSID  | <input checked="" type="checkbox"/> |
| ▶ Enable          | <input checked="" type="checkbox"/> |

For others:

| VAP Configuration |                                 |
|-------------------|---------------------------------|
| Item              | Setting                         |
| ▶ VAP             | VAP2 ▾                          |
| ▶ SSID            | default                         |
| ▶ Max. STA        | <input type="checkbox"/> Enable |
| ▶ Authentication  | Open ▾                          |
| ▶ Encryption      | None ▾                          |
| ▶ STA Isolation   | <input type="checkbox"/>        |
| ▶ Broadcast SSID  | <input type="checkbox"/>        |
| ▶ Enable          | <input type="checkbox"/>        |

For the detail description about VAP configuration, please refer to the description stated in AP-Router section.

### 2.3.2 Wireless Client List

The **Wireless Client List** page shows the information of wireless clients which are associated with this device.

Go to **Basic Network > WiFi > Wireless Client List** Tab.

#### Select Target WiFi

| Target WiFi <span style="float: right;">[ Help ]</span> |         |
|---|---------|
| Item  | Setting |
| ▶ Operation Band  | 2.4G ▾  |
| ▶ Multiple AP Names                                     | All ▾   |

| Target Configuration |                        |   |
|----------------------|------------------------|---|
| Item                 | Value setting          | Description   |
| Operation Band       | A Must filled setting. | Specify the intended operation band for the WiFi module. Basically, this setting is fixed and cannot be changed once the module is integrated into the product. However, there is some module with selectable band for user to choose according to his network environment. Under such situation, you can specify which operation band is suitable for the application. |

|                          |   |   |
|--------------------------|---|---|
| <b>Multiple AP Names</b> | 1. A Must filled setting.<br>2. All is selected by default. | Specify the VAP to show the associated clients information in the following Client List. By default, All VAP is selected. |
|--------------------------|---|---|

## Show Client List

The following Client List shows the information for wireless clients that is associated with the selected VAP(s).

| Client List                        |           |             |      |      |       |       |        |           |
|------------------------------------|-----------|-------------|------|------|-------|-------|--------|-----------|
| IP Address Configuration & Address | Host Name | MAC Address | Mode | Rate | RSSI0 | RSSI1 | Signal | Interface |

| Target Configuration Item          | Value setting | Description   |
|------------------------------------|---------------|---|
| IP Address Configuration & Address | N/A           | It shows the Client's IP address and the deriving method. <b>Dynamic</b> means the IP address is derived from a DHCP server. <b>Static</b> means the IP address is a fixed one that is self-filled by client. |
| Host Name                          | N/A           | It shows the host name of client.   |
| MAC Address                        | N/A           | It shows the MAC address of client.   |
| Mode                               | N/A           | It shows what kind of <b>Wi-Fi system</b> the client used to associate with this device.  |
| Rate                               | N/A           | It shows the <b>data rate</b> between client and this device.   |
| RSSI0, RSSI1                       | N/A           | It shows the RX sensitivity (RSSI) value for each radio path.   |
| Signal                             | N/A           | The <b>signal strength</b> between client and this device.  |
| Interface                          | N/A           | It shows the VAP ID that the client associated with.  |
| Refresh                            | N/A           | Click the <b>Refresh</b> button to update the Client List immediately.  |

### 2.3.3 Advanced Configuration

This device provides advanced wireless configuration for professional user to optimize the wireless performance under the specific installation environment. Please note that if you are not familiar with the WiFi technology, just leave the advanced configuration with its default values, or the connectivity and performance may get worse with improper settings.

Go to **Basic Network > WiFi > Advanced Configuration** Tab.

#### Select Target WiFi

| Target WiFi [ Help ] |         |
|----------------------|---------|
| Item                 | Setting |
| ▶ Operation Band     | 2.4G ▼  |



| Target Configuration |                        |   |
|----------------------|------------------------|---|
| Item                 | Value setting          | Description   |
| Module Select        | A Must filled setting. | Select the WiFi module to check the information of connected clients. For those single WiFi module products, this option is hidden.   |
| Operation Band       | A Must filled setting. | Specify the intended operation band for the WiFi module. Basically, this setting is fixed and cannot be changed once the module is integrated into the product. However, there is some module with selectable band for user to choose according to his network environment. |

## Setup Advanced Configuration

| Advanced Configuration |  |
|------------------------|--|
| Item                   | Setting                                    |
| ▶ Regulatory Domain    | (1-13)                                     |
| ▶ Beacon Interval      | 100 Range: (1~1000 msec)                   |
| ▶ DTIM Interval        | 3 Range: (1~255)                           |
| ▶ RTS Threshold        | 2347 Range: (1~2347)                       |
| ▶ Fragmentation        | 2346 Range: (256~2346)                     |
| ▶ WMM                  | <input checked="" type="checkbox"/> Enable |
| ▶ Short GI             | 400ns ▾                                    |
| ▶ TX Rate              | Best ▾                                     |
| ▶ RF Bandwidth         | HT20 ▾                                     |
| ▶ Transmit Power       | 100% ▾                                     |
| ▶ WIDS                 | <input type="checkbox"/> Enable            |

| Advanced Configuration |   |  |
|------------------------|---|--|
| Item                   | Value setting   | Description  |
| Regulatory Domain      | The default setting is according to where the product sale to | It limits the available radio channel of this device. The permissible channels depend on the <b>Regulatory Domain</b> .  |
| Beacon Interval        | 100   | It shows the time interval between each beacon packet broadcasted. The beacon packet contains <b>SSID</b> , <b>Channel ID</b> and <b>Security setting</b> .  |
| DTIM Interval          | 3   | A <b>DTIM (Delivery Traffic Indication Message)</b> is a countdown informing clients of the next window for listening to broadcast message. When the device has buffered broadcast message for associated client, it sends the next DTIM with a DTIM value.      |
| RTS Threshold          | 2347  | <b>RTS (Request to send) Threshold</b> means when the packet size is over the setting value, then active <b>RTS</b> technique. RTS/CTS is a <b>collision avoidance</b> technique. It means RTS <b>never</b> activated when the threshold is set to <b>2347</b> . |
| Fragmentation          | 2346  | Wireless frames can be divided into smaller units (fragments) to <b>improve performance</b> in the presence of RF interference at the limits of RF coverage.   |
| WMM                    | The box is checked by default                                 | <b>WMM (Wi-Fi Multimedia)</b> can help control <b>latency</b> and <b>jitter</b> when transmitting <b>multimedia content</b> over a wireless connection.  |

|                       |                                     |   |
|-----------------------|-------------------------------------|---|
| <b>Short GI</b>       | By default <b>400ns</b> is selected | <b>Short GI (Guard Interval)</b> is defined to set the sending interval between each packet. Note that lower <b>Short GI</b> could <b>increase</b> not only the <b>transition rate</b> but also <b>error rate</b> . |
| <b>TX Rate</b>        | By default <b>Best</b> is selected  | It means the <b>data transition rate</b> . When <b>Best</b> is selected, the device will choose a proper <b>data rate</b> according to <b>signal strength</b> .   |
| <b>RF Bandwidth</b>   | By default <b>Auto</b> is selected  | The setting of RF bandwidth limits the maximum data rate.   |
| <b>Transmit Power</b> | By default <b>100%</b> is selected  | Normally the wireless transmitter operates at 100% power. By setting the <b>transmit power</b> to control the Wi-Fi <b>coverage</b> .   |
| <b>WIDS</b>           | The box is unchecked by default     | The WIDS (Wireless Intrusion Detection System) will analyze all packets and make a statistic table in WiFi status.<br>Go to <b>Status &gt; Basic Network &gt; WiFi</b> tab for detailed WIDS status.                |
| <b>Save</b>           | N/A                                 | Click the <b>Save</b> button to save the current configuration.   |
| <b>Undo</b>           | N/A                                 | Click the <b>Undo</b> button to restore configuration to previous setting before saving.  |

### 2.3.4 Uplink Profile

This device provides WiFi Uplink function for connecting to a wireless access point just like connected to a wired WAN or cellular WAN connection. It can operate as a NAT gateway and link the devices wirelessly to the uplink network or hosts.

To connect to the wireless access point, user has to enable the wireless Uplink function for a certain WiFi Module (refer to **Basic Network > WAN & Uplink > Physical Interface, Internet Setup** tabs) first, and then configure the Uplink profile(s) for the access point to be connected to in the **Uplink Profile** page.

Go to **Basic Network > WiFi > Uplink Profile** tab for configuring the Uplink Profile page.

### Uplink Profile Setting

| Setting           |   |
|-------------------|---|
| Item              | Setting   |
| ▶ Profile         | <input type="checkbox"/> Enable   |
| ▶ Operation Band  | 2.4G ▾  |
| ▶ Priority        | <input checked="" type="radio"/> By Signal Strength <input type="radio"/> By User-defined |
| ▶ Current Profile |   |

| Setting              |  |  |
|----------------------|--|--|
| Item                 | Value setting  | Description  |
| <b>Profile</b>       | 1. A Must filled setting.<br>2. <b>Unchecked</b> by default. | Check the <b>Enable</b> box to activate the profile function.<br>It is available only when the selected WiFi module is configured at WiFi Uplink mode. |
| <b>Module Select</b> | A Must filled setting.                                       | Select the WiFi module to check or configure the expected uplink profile(s).<br>For those single WiFi module products, this option is hidden.          |

|                       |   |   |
|-----------------------|---|---|
| <b>Operation Band</b> | A Must filled setting.  | Specify the intended operation band for the WiFi module. Basically, this setting is fixed and cannot be changed once the module is integrated into the router product. However, there are some module with selectable band for user to choose according to his network environment. Under such situation, you can specify which operation band is suitable for the application.   |
| <b>Priority</b>       | <ol style="list-style-type: none"> <li>1. A Must filled setting.</li> <li>2. <b>By Signal Strength</b> is selected by default.</li> </ol> | Specify the network selection methodology for connection to an available wireless uplink network. It can be <b>By Signal Strength</b> or <b>By User-defined</b> priority. When <b>By Signal Strength</b> is selected, the router will try to connect to the available uplink network whose wireless signal strength is the strongest. When <b>By User-defined</b> is selected, the router will try to connect to the available uplink network whose priority is the highest (1 is the highest priority, and 16 is the lowest priority). |

**Note:** to apply the defined Uplink profile(s) for the router to find a best fit profile for connecting to a certain uplink network, user has to **Enable** the Profile auto-connect function (Refer to **Basic Network > WiFi > (Module 1/ Module 2) WiFi Configuration** tab).

### Create/Edit Uplink Profile

| <input type="checkbox"/> Profile List <input type="button" value="Add"/> <input type="button" value="Delete"/> <input type="button" value="Get Signal Strength"/> |              |      |         |                |            |             |                 |          |        |         |
|---|--------------|------|---------|----------------|------------|-------------|-----------------|----------|--------|---------|
| ID  | Profile Name | SSID | Channel | Authentication | Encryption | MAC Address | Signal Strength | Priority | Enable | Actions |

The Profile List shows the settings for the created uplink profiles. The information includes Profile Name, SSID, Channel, Authentication, Encryption, MAC Address, Signal Strength, Priority, and Enable.

When **Add** button is applied, **Profile Configuration** screen will appear.

| Profile Configuration |  |
|-----------------------|--|
| Item                  | Setting  |
| ▶ Profile Name        | <input type="text"/>                                     |
| ▶ Network ID (SSID)   | <input type="text"/> <input type="button" value="Scan"/> |
| ▶ Channel             | Auto ▼   |
| ▶ Authentication      | Open ▼   |
| ▶ Encryption          | None ▼   |
| ▶ MAC Address         | <input type="text"/>                                     |
| ▶ Priority            | 16 ▼   |
| ▶ Enable              | <input checked="" type="checkbox"/>                      |

| Profile Configuration    |   |  |
|--------------------------|---|--|
| Item                     | Value setting   | Description  |
| <b>Profile Name</b>      | <ol style="list-style-type: none"> <li>String format can be any text</li> <li>A Must filled setting</li> </ol>        | <p>Enter a profile name for the uplink network specified below. It is a name that is easy for you to understand.</p> <p><b>Value Range: 1 ~ 64 characters.</b></p>   |
| <b>Network ID (SSID)</b> | <ol style="list-style-type: none"> <li>String format : Any text</li> <li>The box is checked by default.</li> </ol>    | <p>Enter the SSID for the VAP, and decide whether to broadcast the SSID or not. The <b>SSID</b> is used for identifying from another AP, and client stations will associate with AP according to SSID. If the broadcast SSID option is enabled, it means the SSID will be broadcasted, and the stations can associate with this device by scanning SSID.</p>   |
| <b>Channel</b>           | <ol style="list-style-type: none"> <li>A Must filled setting.</li> <li><b>Auto</b> is selected by default.</li> </ol> | <p>Select a radio channel for the VAP. Each channel is corresponding to different radio band. The permissible channels depend on the <b>Regulatory Domain</b>. There are two available options when <b>Auto</b> is selected:</p> <ul style="list-style-type: none"> <li>● <b>By AP Numbers</b><br/>The channel will be selected according to AP numbers (The less, the better).</li> <li>● <b>By Less Interference</b><br/>The channel will be selected according to interference. (The lower, the better).</li> </ul> |
| <b>Authentication</b>    | <ol style="list-style-type: none"> <li>A Must filled setting</li> <li><b>Open</b> is selected by default.</li> </ol>  | <p>Specify the authentication method for connecting with the uplink network. It can be <b>Open, Shared, WPA-SPK, or WPA2-PSK</b>.</p> <p>When <b>Open</b> is selected, the pre-shared WEP key could be set for authentication;</p> <p>When <b>Shared</b> is selected, the pre-shared WEP key should be set for authentication;</p> <p>When <b>WPA-PSK</b> or <b>WPA2-PSK</b> is selected, The TKIP or AES pre-shared key should be set for authentication;</p>   |

|                    |   |  |
|--------------------|---|--|
| <b>Encryption</b>  | <ol style="list-style-type: none"> <li>1. A Must filled setting.</li> <li>2. <b>None</b> is selected by default.</li> </ol> | <p>Select a suitable encryption method and enter the required key(s). The available method in the dropdown list depends on the Authentication you selected.</p> <p><b>None</b><br/>It means that the device is open system without encrypting.</p> <p><b>WEP</b><br/>Up to 4 WEP keys can be set, and you have to select one as current key. The key type can set to <b>HEX</b> or <b>ASCII</b>.<br/>If <b>HEX</b> is selected, the key should consist of (0 to 9) and (A to F).<br/>If <b>ASCII</b> is selected, the key should consist of ASCII table.</p> <p><b>TKIP</b><br/>TKIP was proposed instead of WEP without upgrading hardware. Enter a Pre-shared Key for it. The length of key is from 8 to 63 characters.</p> <p><b>AES</b><br/>The newest encryption system in WiFi, it also designed for the fast 802.11n high bitrates schemes. Enter a Pre-shared Key for it. The length of key is from 8 to 63 characters.<br/>You are recommended to use <b>AES</b> encryption instead of any others for security.</p> |
| <b>MAC Address</b> | <ol style="list-style-type: none"> <li>1. MAC Address string Format</li> <li>2. A Must fill setting</li> </ol>              | Specify the <b>MAC Address</b> of the access point (with the Network ID) to be connected to.   |
| <b>Priority</b>    | <ol style="list-style-type: none"> <li>1. An Optional filled setting.</li> <li>2. <b>16</b> is set by default.</li> </ol>   | Specify a priority setting for the uplink profile when the <b>By User-defined</b> methodology is selected. The priority value can be 1 ~ 16. 1 is the highest priority, and 16 is the lowest priority).  |
| <b>Enable</b>      | The box is checked by default.  | Click the <b>Enable</b> box to activate this profile.  |
| <b>Save</b>        | N/A   | Click the <b>Save</b> button to save the configuration.  |
| <b>Undo</b>        | N/A   | Click the <b>Undo</b> button to restore what you just configured back to the previous setting.   |
| <b>Back</b>        | N/A   | When the <b>Back</b> button is clicked, the screen will return to the Profile List page.   |

Instead of manually enter the information for the uplink network, you can also click the **Scan** button to get the available wireless networks around the device, and select one as the uplink network.

When the **Scan** button is applied, **Wireless AP List** will appear after few seconds.

| Wireless AP List |         |         |                |            |                   |                       |
|------------------|---------|---------|----------------|------------|-------------------|-----------------------|
| SSID             | Channel | Quality | Authentication | Encryption | MAC Address       | Select                |
| PDE              | 1       | 65%     | WPA2-PSK       | AES        | 00:22:88:02:6b:e4 | <input type="radio"/> |
| skynet           | 1       | 0%      | WPA2-PSK       | AES        | ec:24:b8:4b:dc:ab | <input type="radio"/> |
| workbench        | 1       | 29%     | WPA2-PSK       | AES        | 00:22:88:02:0d:c0 | <input type="radio"/> |
| Ranc_FreeWiFi    | 1       | 0%      | WPA2-PSK       | AES        | b0:48:7a:ca:6a:d0 | <input type="radio"/> |
| Ubytovna 5       | 2       | 0%      | WPA2-PSK       | AES        | e4:be:ed:bd:06:67 | <input type="radio"/> |
| WLAN11_2G        | 2       | 0%      | WPA2-PSK       | AES        | 1c:49:7b:c6:48:98 | <input type="radio"/> |
| KALIBR           | 2       | 0%      | WPA2-PSK       | AES        | cc:b2:55:94:5a:c6 | <input type="radio"/> |
| TP_LINK          | 8       | 0%      | WPA2-PSK       | AES        | 18:a6:f7:7a:f8:fc | <input type="radio"/> |
| Internet_AA      | 12      | 0%      | WPA2-PSK       | AES        | f8:8e:85:72:d0:ab | <input type="radio"/> |
| advantech        | 13      | 5%      | WPA2-PSK       | AES        | 00:3a:98:22:8d:00 | <input type="radio"/> |

Once you selected an AP from the AP list, the channel, SSID, Authentication, Encryption, and MAC address will be automatically filled into the profile, you just have to enter a key for the uplink connection, if required.

## 2.4 GNSS

The configuration steps include following items.

- Activate GNSS feature in gateway and finish settings of cellular WAN.
- Support NMEA 0183 (compatible to 3.0) protocol, and allow customized prefix and suffix.
- Configurable GPS data logging on local microSD card storage for route record tracking.
- Indicate remote host, time interval, TCP/UDP, and type of GPS data that would be sent.

Please note the available GNSS features on different models may be different. Please check product datasheet for details.

### GPS Message Type

This item shows all supported types of NMEA 0183 data format. NMEA 0183 data format was defined and maintained by National Marine Electronics Association (NMEA). Select one or more types that you want to use for transmitting GPS data. In most case, this configuration depends on which data format that your central server can recognize. Only select the type you need, otherwise it will consume unnecessary network bandwidth. The table below shows more information for different types of NMEA 0183 message.

| GPS Message Type |  |   |
|------------------|--|---|
| Type             | Description                            | Example   |
| GGA              | Fix Information                        | \$GPGGA,123519,4807.038,N,01131.000,E,1,08,0.9,545.4,M,46.9,M,,*47    |
| GLL              | Lat/Lon Data                           | \$GPGLL,4916.45,N,12311.12,W,225444,A,*1D                             |
| GSA              | Overall Satellite Data                 | \$GPGSA,A,3,04,05,,09,12,,,24,,,,,2.5,1.3,2.1*39                      |
| GSV              | Detailed Satellite Data                | \$GPGSV,2,1,08,01,40,083,46,02,17,308,41,12,07,344,39,14,22,228,45*75 |
| RMC              | Recommended Minimum Data               | \$GPRMC,123519,A,4807.038,N,01131.000,E,022.4,084.4,230394,003.1,W*6A |
| VTG              | Vector Track and Speed Over the Ground | \$GPVTG,054.7,T,034.4,M,005.5,N,010.2,K*48                            |

Please note this option is hardware dependent. The available options of GPS message type show on this page is according to product specification. You may not see all options if your product doesn't support all of them.

### Assisted GPS

Assisted GPS (as known as A-GPS) is used for speeding up location fix, especially when satellite signal is weak. If activating this option, gateway will download almanac data from A-GPS server through IP network instead of from satellite. You can also choose different valid period of almanac data. The shorter almanac data will get higher accuracy. However, the almanac data with shorter valid period needs to be updated more frequently. It will consume more network bandwidth. Please note this option is hardware dependent. You may not see this option if your product doesn't support it.

**Data to Storage**

Besides transmitting location data to remote server, you can also store location data into internal storage (e.g. microSD card) or external storage (e.g. USB drive) if any. Regarding to data format, either can be NMEA 0183 raw data format or save it as GPX file format. The location data will be saved to a new file if the original file size is bigger than the pre-defined file size. The “Download log file” button allows you to browse all saved log files and download to your personal devices.

**Scenario of location tracking for fleet management**

A fleet owner would like to see the locations of his trucks in real time. He also likes to know where his trucks have been passed through with time information. In his operation office, there is a server (IP: 100.100.100.1) which can interpret NMEA RMC data format and shows truck’s location and track on map. This server is listening on TCP port 888 to receive NMEA RMC packet from trucks. IMEI number will be added before NMEA RMC data for identification of each truck. Hereunder is the configuration on each truck.

| <b>Basic Settings</b>     |                              |
|---------------------------|------------------------------|
| <b>Configuration Path</b> | <b>[GNSS]-[Cofiguration]</b> |
| GGA                       | Enable                       |
| GLL                       | GPS                          |
| GSA                       | RMC                          |
| GSV                       | Enable                       |
| RMC                       | Enable, 1                    |
| VTG                       | Disable                      |

| <b>Settings for Remote Host</b> |  |
|---------------------------------|--|
| <b>Configuration Path</b>       | <b>[GNSS]-[Remote Host Cofiguration]</b> |
| Host Name                       | Truck-1                                  |
| Host IP                         | 100.100.100.1                            |
| Protocol Type                   | TCP                                      |
| Port Number                     | 888                                      |
| Interval(s)                     | 15                                       |
| Prefix Message                  | 123456789012345                          |
| Suffix Message                  | [blank]                                  |
| Enable Checkbox                 | [Checked]                                |



## GNSS Setting

Go to **Service>Location Tracking> GNSS** Tab.

The **GNSS** allows user to set the configuration of GNSS, log NMEA data to storage, and send data to remote host. Ensure GNSS is enabled and saved

### Setup GNSS Configuration

| Item                 | Setting   |
|----------------------|---|
| ▶ GNSS               | <input checked="" type="checkbox"/> Enable  |
| ▶ GNSS Type          | GPS ▼   |
| ▶ GNSS Message Types | <input checked="" type="checkbox"/> RMC   |
| ▶ Assisted GPS       | <input checked="" type="checkbox"/> Enable  |
| ▶ Data to Storage    | <input type="checkbox"/> Enable    Select Device: Internal ▼<br>Interval: 5 (s)<br>Data format: RAW ▼<br>Data file name: <input type="text"/><br>Split file: <input type="checkbox"/> Enable    Size: 200 KB ▼<br><input type="button" value="Download log file"/> <input type="button" value="Delete log file"/> |

### GNSS Configuration

| Item                      | Value setting                      | Description  |
|---------------------------|------------------------------------|--|
| <b>GNSS Enable</b>        | The box is unchecked by default    | Check <b>Enable</b> box to activate GNSS functions.  |
| <b>GNSS Type</b>          | <b>GPS</b> is selected by default  | Select a <b>GNSS Type</b> (GNSS System) that you want to use. Please note this option is hardware dependent. The available options of GNSS type show on this page is according to product specification. You may not see all of these four options if your product doesn't support all of them.  |
| <b>GNSS Message Types</b> | These box is unchecked by default. | Select one or more <b>GNSS Message Types</b> that you want to use for transmitting or recording GPS data. There are many sentences in the NMEA standard for selecting, <b>GGA, GLL, GSA, GSV, RMC</b> and <b>VTG</b> . <b>ALL Other</b> includes DTM, GNS, GRS, GST, ZDA, and GBS sentences. Only select the type you need, otherwise it will consume unnecessary network bandwidth. Note: The supported message type is hardware dependent. |
| <b>Assisted GPS</b>       | The box is checked by default      | Check <b>Enable</b> box to activate Assisted GPS (A-GPS). Select the duration for downloading the <b>Differential Almanac Corrections</b> data from A-GPS server through IP network. Note: Some devices may not support this function.   |

|                        |                          |   |
|------------------------|--------------------------|---|
| <b>Data to Storage</b> | Recommended Minimum Data | <ul style="list-style-type: none"> <li>• <b>Enable</b> (The box is unchecked by default)<br/>Check <b>Enable</b> box to activate data to storage function.</li> <li>• <b>Select Device</b> (A Must filled setting)<br/>Select <b>Internal</b> or <b>External</b> device to store log data.</li> <li>• <b>Interval</b> (A Must filled setting)<br/>Specify the time interval between two continuous data log. By default, 5 second is set.<br/><i>Value Range:</i> 5 ~ 60 seconds.</li> <li>• <b>Data Format</b>(A Must filled setting)<br/>Select data format (<b>RAW</b>, or <b>GPX</b>) to store.</li> <li>• <b>Data file name</b>(A Must filled setting)<br/>Define file name to store.</li> <li>• <b>Split Enable</b><br/>Check <b>Enable</b> box to activate file splitting function.</li> <li>• <b>Split Size&amp; Unit</b><br/>Define file size and unit for log file. By default, 200 KB is defined.<br/><i>Value Range:</i> &gt;= 10KB (Minimum file size is 10 KB).</li> <li>• <b>Download log file</b><br/>Select a log file and Click <b>Download log file</b> to download through Web GUI. If the log format which is specified to download is GPX, we will convert standard GPX format for used.</li> </ul> |
| <b>Save</b>            | N/A                      | Click the <b>Save</b> button to save the configuration  |

## Create / Edit Remote Host

The Remote Host allows you to customize your rules for sending NMEA data to specific IP address and Port. The router supports up to a maximum of 10 rule sets.

| Remote Host List  |           |         |               |             |             |                |                |        |         |
|---|-----------|---------|---------------|-------------|-------------|----------------|----------------|--------|---------|
| <div style="float: right;"> <input type="button" value="Add"/> <input type="button" value="Delete"/> </div> |           |         |               |             |             |                |                |        |         |
| ID  | Host Name | Host IP | Protocol Type | Port Number | Interval(s) | Prefix Message | Suffix Message | Enable | Actions |

When **Add** button is applied, **Remote Host Configuration** screen will appear.

| Remote Host Configuration |                          |
|---------------------------|--------------------------|
| Item                      | Setting                  |
| ▶ Host Name               | <input type="text"/>     |
| ▶ Host IP                 | <input type="text"/>     |
| ▶ Protocol Type           | TCP ▼                    |
| ▶ Port Number             | <input type="text"/>     |
| ▶ Interval(s)             | 1                        |
| ▶ Prefix Message          | <input type="text"/>     |
| ▶ Suffix Message          | <input type="text"/>     |
| ▶ Enable                  | <input type="checkbox"/> |

| Remote Host Configuration |                                 |   |
|---------------------------|---------------------------------|---|
| Item                      | Value setting                   | Description   |
| Host Name                 | String format: any text         | Enter the host name for the designated remote host.<br><i>Value Range:</i> -1 ~ 64 characters.  |
| Host IP                   | A Must filled setting           | Specify the <b>IP Address</b> of remote host. It will be use as destination IP for sending NMEA packets.  |
| Protocol Type             | TCP is selected by default      | Specify the <b>Protocol (TCP or UDP)</b> to use for sending NMEA packets.   |
| Port Number               | A Must filled setting           | Specify a <b>Port Number</b> as destination port for sending NMEA packets.<br><i>Value Range:</i> 1 ~ 65535.  |
| Interval(s)               | A Must filled setting           | Specify the time <b>interval</b> (seconds) between two NMEA packets.<br><i>Value Range:</i> 1 ~255 seconds.   |
| Prefix Message            | String format: any text         | Specify optional prefix string with specific information if your backend server can recognize.<br>For example, you can input the IMEI code of this device here, and then your backend server can recognize this GPS data is sent from this device. You can also leave this field blank. |
| Suffix Message            | String format: any text         | Specify optional suffix string with specific information if your backend server can recognize.  |
| Enable                    | The box is unchecked by default | Check <b>Enable</b> box to activate this remote host rule.  |
| Save                      | N/A                             | Click the <b>Save</b> button to save the configuration  |

## 2.5 IPv6

The growth of the Internet has created a need for more addresses than are possible with IPv4. IPv6 (Internet Protocol version 6) is a version of the Internet Protocol (IP) intended to succeed IPv4, which is the protocol currently used to direct almost all Internet traffic. IPv6 also implements additional features not present in IPv4. It simplifies aspects of address assignment (stateless address auto-configuration), network renumbering and router announcements when changing Internet connectivity providers.

### 2.5.1 IPv6 Configuration

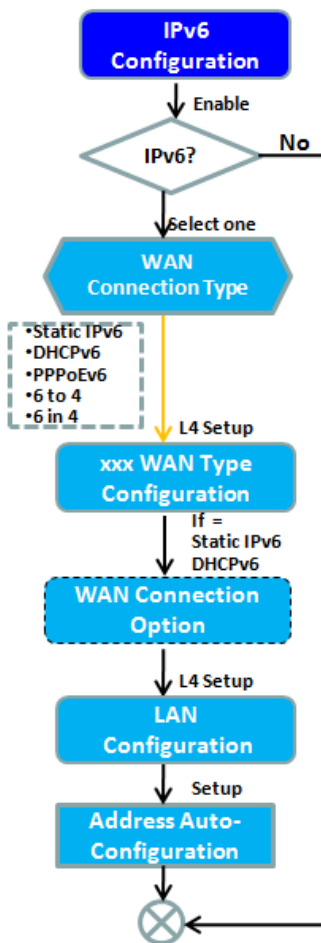

| IPv6 Configuration [ Help ]     |   |
|---------------------------------|---|
| Item                            | Setting   |
| ▶ IPv6                          | <input type="checkbox"/> Enable   |
| ▶ WAN Connection Type           | IPv6 ▾  |
| DHCPv6 WAN Type Configuration   |   |
| ▶ DNS                           | <input checked="" type="radio"/> From Server <input type="radio"/> Specific DNS |
| ▶ Primary DNS                   | <input type="text"/>  |
| ▶ Secondary DNS                 | <input type="text"/>  |
| ▶ MLD Snooping                  | <input type="checkbox"/> Enable   |
| LAN Configuration               |   |
| ▶ Global Address                | <input type="text"/>  |
| ▶ Link-local Address            | fe80::2d0:c9ff:fe5d:53f3  |
| Address Auto-configuration      |   |
| ▶ Auto-configuration            | <input checked="" type="checkbox"/> Enable                                      |
| ▶ Auto-configuration Type       | Stateless ▾   |
| ▶ Router Advertisement Lifetime | <input type="text" value="200"/> (seconds)                                      |

The **IPv6 Configuration** setting allows user to set the IPv6 connection type to access the IPv6 network. This router supports various types of IPv6 connection, including **Static IPv6**, **DHCPv6**, and **PPPoEv6**

**Note:** For the products just having 3G/4G WAN interface, only **IPv6** is supported. Please contact your ISP for the IPv6 supports before you proceed with IPv6 setup.

## IPv6 WAN Connection Type

### Static IPv6

Static IPv6 does the same function as static IPv4. The static IPv6 provides manual setting of IPv6 address, IPv6 default router address, and IPv6 DNS.

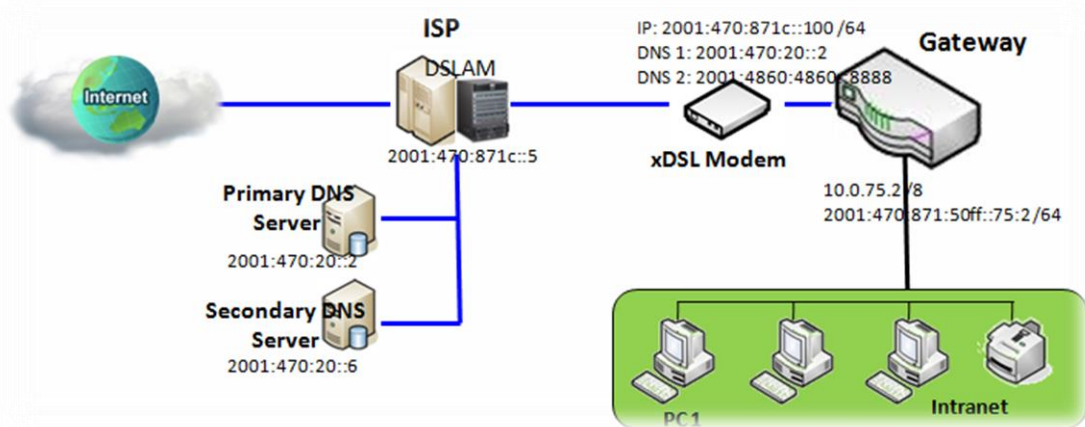

Above diagram depicts the IPv6 IP addressing, type in the information provided by your ISP to setup the IPv6 network.

### DHCPv6

DHCP in IPv6 does the same function as DHCP in IPv4. The DHCP server sends IP address, DNS server addresses and other possible data to the DHCP client to configure automatically. The server also sends a lease time of the address and time to re-contact the server for IPv6 address renewal. The client has then to resend a request to renew the IPv6 address.

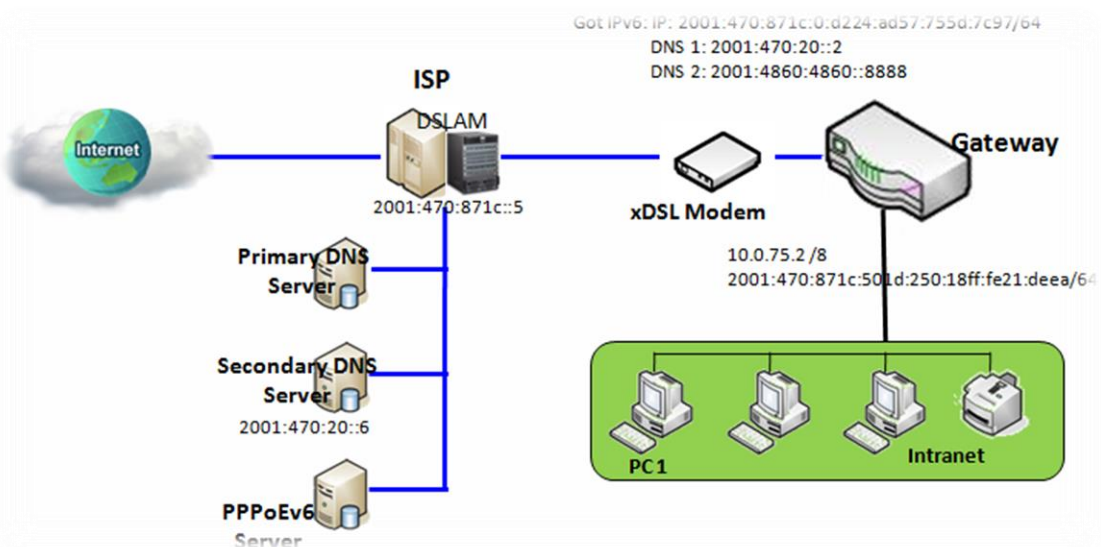

Above diagram depicts DHCP IPv6 IP addressing, the DHCPv6 server on the ISP side assigns IPv6 address, IPv6 default router address, and IPv6 DNS to client host's automatically.

**PPPoEv6**

PPPoEv6 in IPv6 does the same function as PPPoE in IPv4. The PPPoEv6 server provides configuration parameters based on PPPoEv6 client request. When PPPoEv6 server gets client request and successfully authenticates it, the server sends IP address, DNS server addresses and other required parameters to automatically configure the client.

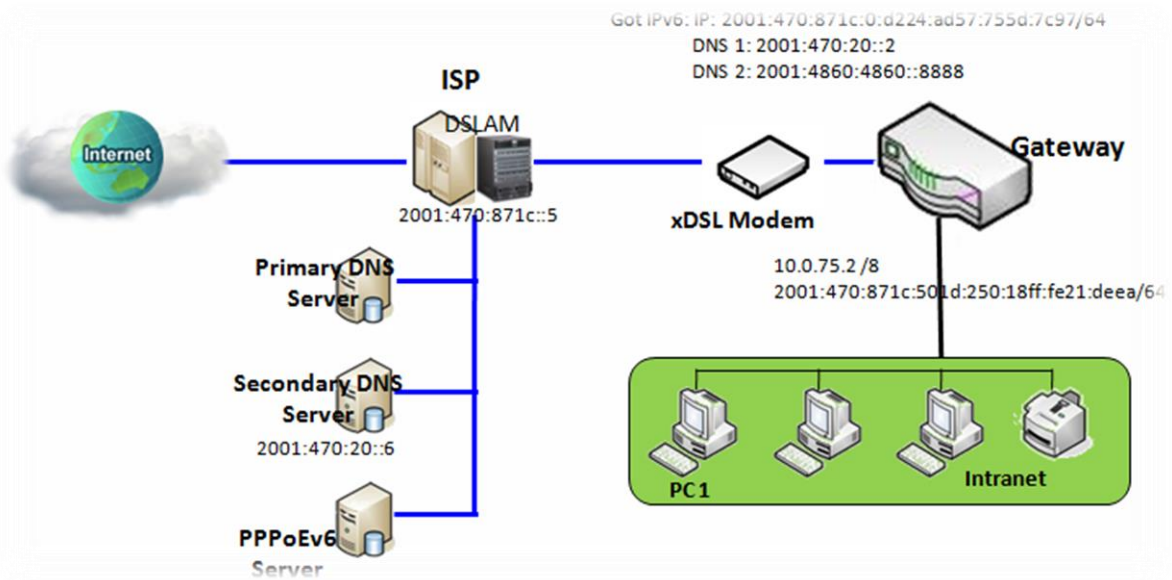

The diagram above depicts the IPv6 addressing through PPPoE, PPPoEv6 server (DSLAM) on the ISP side provides IPv6 configuration upon receiving PPPoEv6 client request. When PPPoEv6 server gets client request and successfully authenticates it, the server sends IP address, DNS server addresses and other required parameters to automatically configure the client.

## IPv6 Configuration Setting

Go to **Basic Network > IPv6 > Configuration** Tab.

The **IPv6 Configuration** setting allows user to set the IPv6 connection type to access the IPv6 network.

| IPv6 Configuration [ Help ] |  |
|-----------------------------|--|
| Item                        | Setting                                    |
| ▶ IPv6                      | <input checked="" type="checkbox"/> Enable |
| ▶ WAN Connection Type       | IPv6 ▾                                     |

| IPv6 Configuration  |  |  |
|---------------------|--|--|
| Item                | Value setting  | Description  |
| IPv6                | The box is unchecked by default,                                     | Check the <b>Enable</b> box to activate the IPv6 function.   |
| WAN Connection Type | 1. Only can be selected when IPv6 Enable<br>2. A Must filled setting | Define the selected IPv6 WAN Connection Type to establish the IPv6 connectivity. For this product only <b>IPv6</b> is supported. |

## DHCPv6 WAN Type Configuration

| DHCPv6 WAN Type Configuration |   |
|-------------------------------|---|
| ▶ DNS                         | <input checked="" type="radio"/> From Server <input type="radio"/> Specific DNS |
| ▶ Primary DNS                 | <input type="text"/>  |
| ▶ Secondary DNS               | <input type="text"/>  |
| ▶ MLD Snooping                | <input type="checkbox"/> Enable   |

| DHCPv6 WAN Type Configuration |   |  |
|-------------------------------|---|--|
| Item                          | Value setting                                   | Description  |
| DNS                           | The option [From Server] is selected by default | Select the [Specific DNS] option to active Primary DNS and Secondary DNS. Then fill the DNS information. |
| Primary DNS                   | Cannot modified by default                      | Enter the WAN <b>primary DNS Server</b> .  |
| Secondary DNS                 | Cannot modified by default                      | Enter the WAN <b>secondary DNS Server</b> .  |
| MLD                           | The box is unchecked by default                 | Enable/Disable the MLD Snooping function   |

## LAN Configuration

|                      |                          |
|----------------------|--------------------------|
| LAN Configuration    |                          |
| ▶ Global Address     |                          |
| ▶ Link-local Address | fe80::2d0:c9ff:febd:53f3 |

| LAN Configuration  |                    |  |
|--------------------|--------------------|--|
| Item               | Value setting      | Description  |
| Global Address     | Value auto-created | Enter the LAN IPv6 Address for the router.               |
| Link-local Address | Value auto-created | Show the link-local address for LAN interface of router. |

Then go to **Address Auto-configuration (summary)** for setting LAN environment.

If above setting is configured, click the **Save** button to save the configuration, and click **Reboot** button to reboot the router.

## Address Auto-configuration

|                                 |  |
|---------------------------------|--|
| Address Auto-configuration      |  |
| ▶ Auto-configuration            | <input checked="" type="checkbox"/> Enable |
| ▶ Auto-configuration Type       | Stateless ▾                                |
| ▶ Router Advertisement Lifetime | 200 (seconds)                              |

| Address Auto-configuration |   |  |
|----------------------------|---|--|
| Item                       | Value setting   | Description  |
| Auto-configuration         | The box is unchecked by default   | Check to enable the Auto configuration feature.  |
| Auto-configuration Type    | 1. Only can be selected when <b>Auto-configuration</b> enabled<br>2. Stateless is selected by default | Define the selected IPv6 WAN Connection Type to establish the IPv6 connectivity.<br>Select <b>Stateless</b> to manage the Local Area Network to be SLAAC + RDNSS<br><b>Router Advertisement Lifetime</b> (A Must filled setting): Enter the Router Advertisement Lifetime (in seconds). 200 is set by default.<br><i>Value Range:</i> 0 ~ 65535. |



## 2.6 Port Forwarding

Network address translation (NAT) is a methodology of remapping one IP address space into another by modifying network address information in Internet Protocol (IP) datagram packet headers while they are in transit across a traffic routing device. The technique was originally used for ease of rerouting traffic in IP networks without renumbering every host. It has become a popular and essential tool in conserving global address space allocations in face of IPv4 address exhaustion. The product you purchased embeds and activates the NAT function. You also can disable the NAT function in **[Basic Network]-[WAN & Uplink]-[Internet Setup]-[WAN Type Configuration]** page.

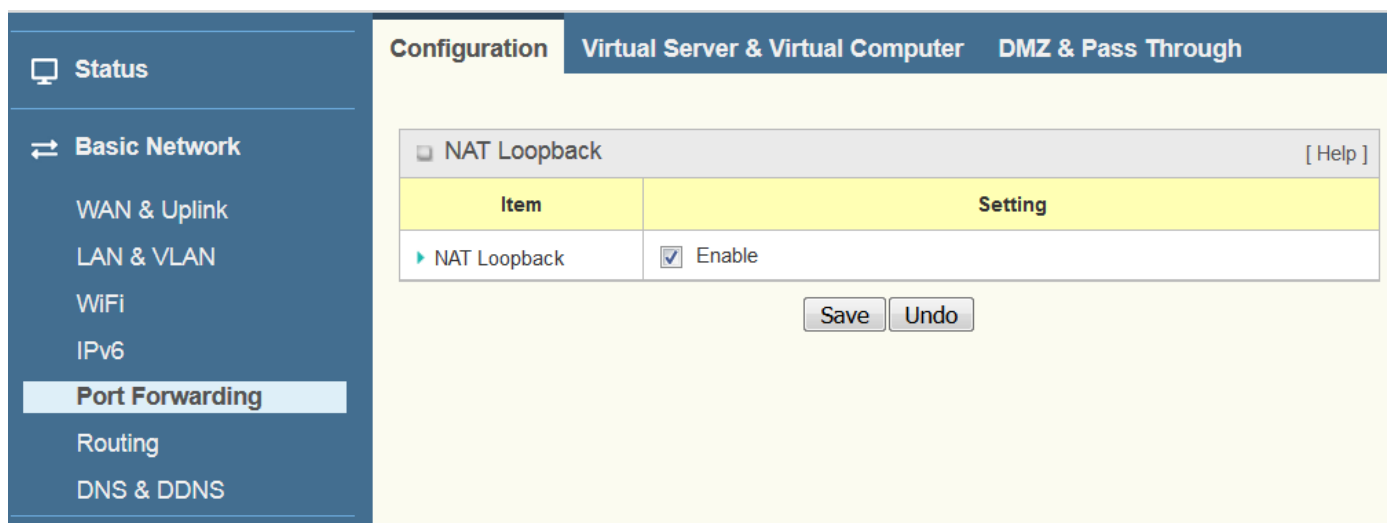

Usually all local hosts or servers behind corporate router are protected by NAT firewall. NAT firewall will filter out unrecognized packets to protect your Intranet. So, all local hosts are invisible to the outside world. Port forwarding or port mapping is function that redirects a communication request from one address and port number combination to assigned one. This technique is most commonly used to make services on a host residing on a protected or masqueraded (internal) network available to hosts on the opposite side of the router (external network), by remapping the destination IP address and port number

There are several optional Port Forwarding related functions in this router. They are Virtual Server, Virtual Computer, IP Translation, Special AP & ALG, DMZ and Pass Through, etc. The available functions might be different for the purchased model.

## 2.6.1 Configuration

### NAT Loopback

This feature allows you to access the WAN global IP address from your inside NAT local network. It is useful when you run a server inside your network. For example, if you set a mail server at LAN side, your local devices can access this mail server through router’s global IP address when enable NAT loopback feature. On either side are you in accessing the email server, at the LAN side or at the WAN side, you don’t need to change the IP address of the mail server.

### Configuration Setting

Go to **Basic Network > Port Forwarding > Configuration** tab.

The NAT Loopback allows user to access the WAN IP address from inside your local network.

### Enable NAT Loopback

| <input type="checkbox"/> NAT Loopback <span style="float: right;">[ Help ]</span> |  |
|---|--|
| Item  | Setting                                    |
| ▶ NAT Loopback  | <input checked="" type="checkbox"/> Enable |

| Configuration |                               |   |
|---------------|-------------------------------|---|
| Item          | Value setting                 | Description   |
| NAT Loopback  | The box is checked by default | Check the <b>Enable</b> box to activate this NAT function |
| Save          | N/A                           | Click the <b>Save</b> button to save the settings.        |
| Undo          | N/A                           | Click the <b>Undo</b> button to cancel the settings       |

### 2.6.2 Virtual Server & Virtual Computer

▣ Configuration

| Item               | Setting                                    |
|--------------------|--|
| ▶ Virtual Server   | <input checked="" type="checkbox"/> Enable |
| ▶ Virtual Computer | <input checked="" type="checkbox"/> Enable |

▣ Virtual Server List
Add
Delete

| ID | WAN Interface | Server IP   | Protocol         | Public Port | Private Port | Time Schedule | Enable                              | Actions  |
|----|---------------|-------------|------------------|-------------|--------------|---------------|-------------------------------------|--|
| 1  | All           | 10.0.75.101 | TCP(6) & UDP(17) | 25          | 25           | (0) Always    | <input checked="" type="checkbox"/> | <input type="button" value="Edit"/> <input type="checkbox"/><br>Select |
| 2  | All           | 10.0.75.101 | TCP(6) & UDP(17) | 110         | 110          | (0) Always    | <input checked="" type="checkbox"/> | <input type="button" value="Edit"/> <input type="checkbox"/><br>Select |

▣ Virtual Computer List
Add
Delete

| ID | Global IP    | Local IP    | Enable                              | Actions  |
|----|--------------|-------------|-------------------------------------|--|
| 1  | 118.18.81.44 | 10.0.75.102 | <input checked="" type="checkbox"/> | <input type="button" value="Edit"/> <input type="checkbox"/><br>Select |

There are some important Port Forwarding functions implemented within the router, including "Virtual Server", "NAT loopback" and "Virtual Computer".

It is necessary for cooperate staffs who travel outside and want to access various servers behind office router. You can set up those servers by using "Virtual Server" feature. After trip, if want to access those servers from LAN side by global IP, without change original setting, NAT Loopback can achieve it.

"Virtual computer" is a host behind NAT router whose IP address is a global one and is visible to the outside world. Since it is behind NAT, it is protected by router firewall. To configure Virtual Computer, you just have to map the local IP of the virtual computer to a global IP.

### Virtual Server & NAT Loopback

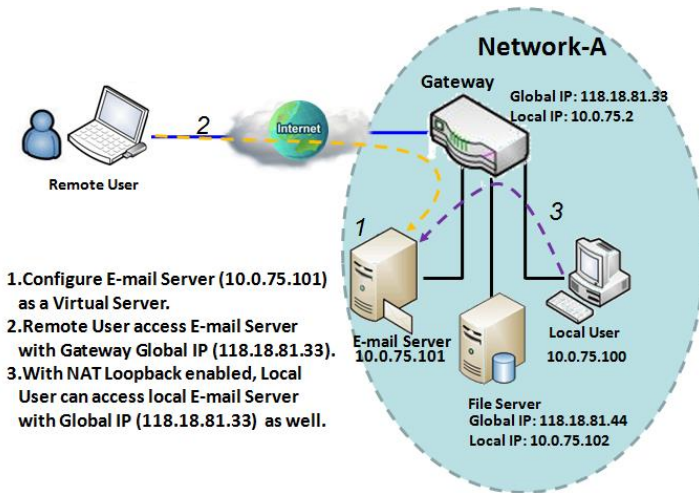

1. Configure E-mail Server (10.0.75.101) as a Virtual Server.
2. Remote User access E-mail Server with Gateway Global IP (118.18.81.33).
3. With NAT Loopback enabled, Local User can access local E-mail Server with Global IP (118.18.81.33) as well.

"Virtual Server" allows you to access servers with the global IP address or FQDN of the gateway as if they are servers existed in the Internet. But in fact, these servers are located in the Intranet and are physically behind the gateway. The gateway serves the service requests by port forwarding the requests to the LAN servers and transfers the replies from LAN servers to the requester on the WAN side. As shown in example, an E-mail virtual server is defined to be located at a server with IP address 10.0.75.101 in the Intranet of Network-A, including SMTP service port 25 and POP3 service port 110. So, the remote user can access the E-mail server with the gateway's global IP 118.18.81.33 from its WAN side. But the real E-mail server is located at LAN side and the gateway is the port forwarder for E-mail service.

NAT Loopback allows you to access the WAN global IP address from your inside NAT local network. It is useful when you run a server inside your network. For example, if you set a mail server at LAN side, your local devices can access this mail server through gateway's global IP address when enable NAT loopback feature. On either side are you in accessing the email server, at the LAN side or at the WAN side, you don't need to change the IP address of the mail server.

### Virtual Computer

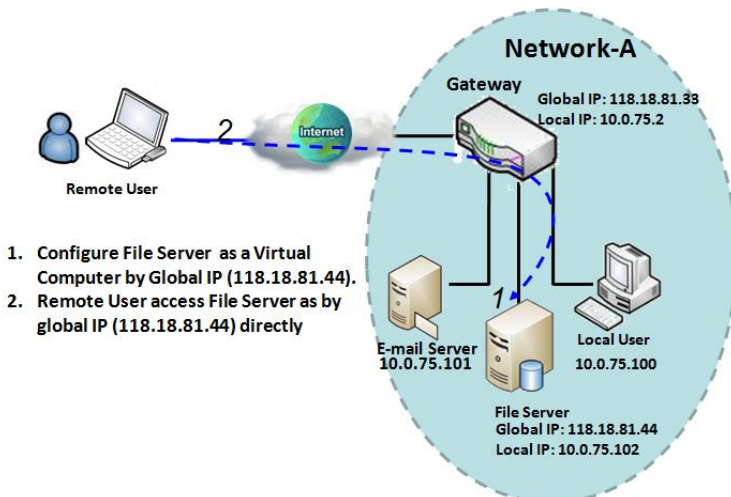

1. Configure File Server as a Virtual Computer by Global IP (118.18.81.44).
2. Remote User access File Server as by global IP (118.18.81.44) directly

"Virtual Computer" allows you to assign LAN hosts to global IP addresses, so that they can be visible to outside world. While so, they are also protected by the gateway firewall as being client hosts in the Intranet. For example, if you set a FTP file server at LAN side with local IP address 10.0.75.102 and global IP address 118.18.82.44, a remote user can access the file server while it is hidden behind the NAT gateway. That is because the gateway takes care of all accessing to the IP address 118.18.82.44, including to forward the access requests to the file server and to send the replies from the server to outside world.

## Virtual Server & Virtual Computer Setting

Go to **Basic Network > Port Forwarding > Virtual Server & Virtual Computer** tab.

### Enable Virtual Server and Virtual Computer

| Configuration      |  |
|--------------------|--|
| Item               | Setting                                    |
| ▶ Virtual Server   | <input checked="" type="checkbox"/> Enable |
| ▶ Virtual Computer | <input checked="" type="checkbox"/> Enable |

| Configuration    |                                 |   |
|------------------|---------------------------------|---|
| Item             | Value setting                   | Description   |
| Virtual Server   | The box is unchecked by default | Check the <b>Enable</b> box to activate this port forwarding function |
| Virtual Computer | The box is checked by default   | Check the <b>Enable</b> box to activate this port forwarding function |
| Save             | N/A                             | Click the <b>Save</b> button to save the settings.                    |
| Undo             | N/A                             | Click the <b>Undo</b> button to cancel the settings.                  |

### Create / Edit Virtual Server

The router allows you to custom your Virtual Server rules. It supports up to a maximum of 20 rule-based Virtual Server sets.

| Virtual Server List <input type="button" value="Add"/> <input type="button" value="Delete"/> |               |           |          |             |              |               |        |         |
|--|---------------|-----------|----------|-------------|--------------|---------------|--------|---------|
| ID   | WAN Interface | Server IP | Protocol | Public Port | Private Port | Time Schedule | Enable | Actions |

When **Add** button is applied, **Virtual Server Rule Configuration** screen will appear.

| Virtual Server Rule Configuration |   |
|-----------------------------------|---|
| Item                              | Setting   |
| ▶ WAN Interface                   | <input checked="" type="checkbox"/> All <input type="checkbox"/> WAN-1 <input type="checkbox"/> WAN-2 |
| ▶ Server IP                       | <input type="text"/>  |
| ▶ Protocol                        | TCP(6) & UDP(17) ▼  |
| ▶ Public Port                     | Single Port ▼ <input type="text"/>  |
| ▶ Private Port                    | Single Port ▼ <input type="text"/>  |
| ▶ Time Schedule                   | (0) Always ▼  |
| ▶ Rule                            | <input type="checkbox"/> Enable   |

| Virtual Server Rule Configuration                            |  |  |
|--|--|--|
| Item   | Value setting  | Description  |
| <b>WAN Interface</b>   | 1. A Must filled setting<br>2. Default is <b>ALL</b> . | Define the selected interface to be the packet-entering interface of the router.<br>If the packets to be filtered are coming from <b>WAN-x</b> then select <b>WAN-x</b> for this field.<br>Select <b>ALL</b> for packets coming into the router from any interface.<br>It can be selected <b>WAN-x</b> box when <b>WAN-x</b> enabled.<br><b>Note:</b> The available check boxes ( <b>WAN-1 ~ WAN-4</b> ) depend on the number of WAN interfaces for the product.   |
| <b>Server IP</b>   | A Must filled setting                                  | This field is to specify the IP address of the interface selected in the WAN Interface setting above.  |
| <b>Protocol</b><br><b>Public Port</b><br><b>Private Port</b> | A Must filled setting                                  | When " <b>ICMPv4</b> " is selected<br>It means the option "Protocol" of packet filter rule is ICMPv4.<br>Apply <b>Time Schedule</b> to this rule, otherwise leave it as <b>Always</b> . (refer to <b>Scheduling setting</b> under <b>Object Definition</b> )<br>Then check <b>Enable</b> box to enable this rule.<br><br>When " <b>TCP</b> " is selected<br>It means the option "Protocol" of packet filter rule is TCP.<br><b>Public Port</b> selected a predefined port from <b>Well-known Service</b> , and <b>Private Port</b> is the same with <b>Public Port</b> number.<br><b>Public Port</b> is selected <b>Single Port</b> and specify a port number, and <b>Private Port</b> can be set a <b>Single Port</b> number.<br><b>Public Port</b> is selected <b>Port Range</b> and specify a port range, and <b>Private Port</b> can be selected <b>Single Port</b> or <b>Port Range</b> .<br><u>Value Range:</u> 1 ~ 65535 for Public Port, Private Port. |

|                      |  |   |
|----------------------|--|---|
|                      |  | <p>When <b>“UDP”</b> is selected<br/>It means the option “Protocol” of packet filter rule is UDP.<br/><b>Public Port</b> selected a predefined port from <b>Well-known Service</b>, and <b>Private Port</b> is the same with <b>Public Port</b> number.<br/><b>Public Port</b> is selected <b>Single Port</b> and specify a port number, and <b>Private Port</b> can be set a <b>Single Port</b> number.<br/><b>Public Port</b> is selected <b>Port Range</b> and specify a port range, and <b>Private Port</b> can be selected <b>Single Port</b> or <b>Port Range</b>.<br/><u>Value Range</u>: 1 ~ 65535 for Public Port, Private Port.</p>                   |
|                      |  | <p>When <b>“TCP &amp; UDP”</b> is selected<br/>It means the option “Protocol” of packet filter rule is TCP and UDP.<br/><b>Public Port</b> selected a predefined port from <b>Well-known Service</b>, and <b>Private Port</b> is the same with <b>Public Port</b> number.<br/><b>Public Port</b> is selected <b>Single Port</b> and specify a port number, and <b>Private Port</b> can be set a <b>Single Port</b> number.<br/><b>Public Port</b> is selected <b>Port Range</b> and specify a port range, and <b>Private Port</b> can be selected <b>Single Port</b> or <b>Port Range</b>.<br/><u>Value Range</u>: 1 ~ 65535 for Public Port, Private Port.</p> |
|                      |  | <p>When <b>“GRE”</b> is selected<br/>It means the option “Protocol” of packet filter rule is GRE.</p>   |
|                      |  | <p>When <b>“ESP”</b> is selected<br/>It means the option “Protocol” of packet filter rule is ESP.</p>   |
|                      |  | <p>When <b>“SCTP”</b> is selected<br/>It means the option “Protocol” of packet filter rule is SCTP.</p>   |
|                      |  | <p>When <b>“User-defined”</b> is selected<br/>It means the option “Protocol” of packet filter rule is User-defined.<br/>For <b>Protocol Number</b>, enter a port number.</p>  |
| <b>Time Schedule</b> | <ol style="list-style-type: none"> <li>1. An optional filled setting</li> <li>2. <b>(0)Always</b> Is selected by default.</li> </ol> | Apply Time Schedule to this rule; otherwise leave it as <b>(0)Always</b> . (refer to Scheduling setting under Object Definition)  |
| <b>Rule</b>          | <ol style="list-style-type: none"> <li>1. An optional filled setting</li> <li>2. The box is unchecked by default.</li> </ol>         | Check the Enable box to activate the rule.  |
| <b>Save</b>          | N/A  | Click the <b>Save</b> button to save the settings.  |
| <b>Undo</b>          | N/A  | Click the <b>Undo</b> button to cancel the settings.  |
| <b>Back</b>          | N/A  | When the <b>Back</b> button is clicked the screen will return to previous page.   |

### Create / Edit Virtual Computer

The router allows you to custom your Virtual Computer rules. It supports up to a maximum of 20 rule-based Virtual Computer sets.

| <input type="checkbox"/> Virtual Computer List <input type="button" value="Add"/> <input type="button" value="Delete"/> |           |          |        |         |
|---|-----------|----------|--------|---------|
| ID  | Global IP | Local IP | Enable | Actions |

When **Add** button is applied, **Virtual Computer Rule Configuration** screen will appear.

| <input type="checkbox"/> Virtual Computer Rule Configuration    [ Help ] |                      |                          |
|--|----------------------|--------------------------|
| Global IP  | Local IP             | Enable                   |
| <input type="text"/>   | <input type="text"/> | <input type="checkbox"/> |
| <input type="button" value="Save"/>                                      |                      |                          |

| Virtual Computer Rule Configuration |                       |  |
|-------------------------------------|-----------------------|--|
| Item                                | Value setting         | Description  |
| Global IP                           | A Must filled setting | This field is to specify the IP address of the WAN IP. |
| Local IP                            | A Must filled setting | This field is to specify the IP address of the LAN IP. |
| Enable                              | N/A                   | Then check <b>Enable</b> box to enable this rule.      |
| Save                                | N/A                   | Click the <b>Save</b> button to save the settings.     |

### 2.6.3 Special AP & ALG

As a NAT gateway, it doesn't allow an active connection request from outside world. All this kind of requests will be ignored by the NAT gateway. But at the client hosts in the Intranet, users may use applications that need more service ports to be allowed for passing through the NAT gateway. The "Special AP (application)" feature in the gateway can solve this problem. That is, some applications require multiple connections, like Internet games, Video conferencing, Internet telephony, etc. Because of the firewall function, these applications cannot work with a pure NAT gateway. The Special AP feature allows some of these applications to work with this product.

Besides, application-level gateway (ALG) allows customized NAT traversal filters to be plugged into the gateway to support address and port translation for certain application layer "control/data" protocols such as FTP, BitTorrent, SIP, RTSP, file transfer in IM applications, etc. In order for these protocols to work through NAT or a firewall, either the application has to know about an address/port number combination that allows incoming packets, or the NAT has to monitor the control traffic and open up port mappings (firewall pinhole) dynamically as required. Legitimate application data can thus be passed through the



security checks of the firewall or NAT that would have otherwise restricted the traffic for not meeting its limited filter criteria.

**Special AP**

| Special AP List <input type="button" value="Add"/> <input type="button" value="Delete"/> |               |              |                       |               |                                     |   |
|--|---------------|--------------|-----------------------|---------------|-------------------------------------|---|
| ID   | WAN Interface | Trigger Port | Incoming Ports        | Time Schedule | Enable                              | Actions   |
| 1  | ALL           | 554          | 6970-6999             | (0) Always    | <input checked="" type="checkbox"/> | <input type="button" value="Edit"/> <input type="checkbox"/> Select |
| 2  | ALL           | 47624        | 2300-2400,28800-29000 | (0) Always    | <input type="checkbox"/>            | <input type="button" value="Edit"/> <input type="checkbox"/> Select |

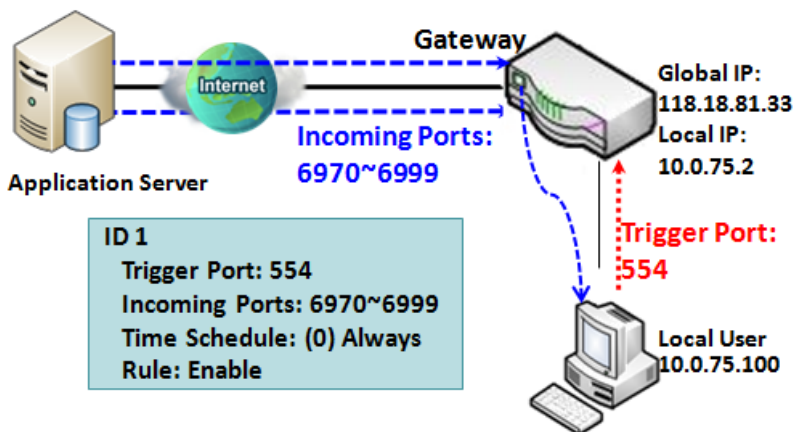

The Special AP feature allows you to request the gateway open a pre-defined service ports for incoming packets to pass through once the trigger port is activated by local hosts. As shown in the diagram, special AP rule define port **554** as trigger port and **6970~6999** as incoming ports. With such setting, local user at host 10.0.75.100 can enjoy the music by using Quick Time application,

whose media server is located in the Internet. When you open application, it will activate Trigger Port and then incoming data packet from remote application server will pass through incoming port 6970~6999.

**SIP ALG**

This gateway supports the SIP ALG feature to allow one SIP phone behind the NAT gateway can call another SIP phone in the Internet, even the gateway executes its NAT mechanism between the Intranet and the Internet. The NAT gateway monitors the control traffic and open up port mappings (firewall pinhole) dynamically as required to know about an address/port number combination that allows incoming packets, so it will support address and port translation for SIP application layer "control/data" protocols as shown in following diagram. The NAT Gateway enables the SIP ALG feature, so it will monitor the SIP Phone #1 actions, open up the required ports and make the address and port translation in a SIP voice communication.

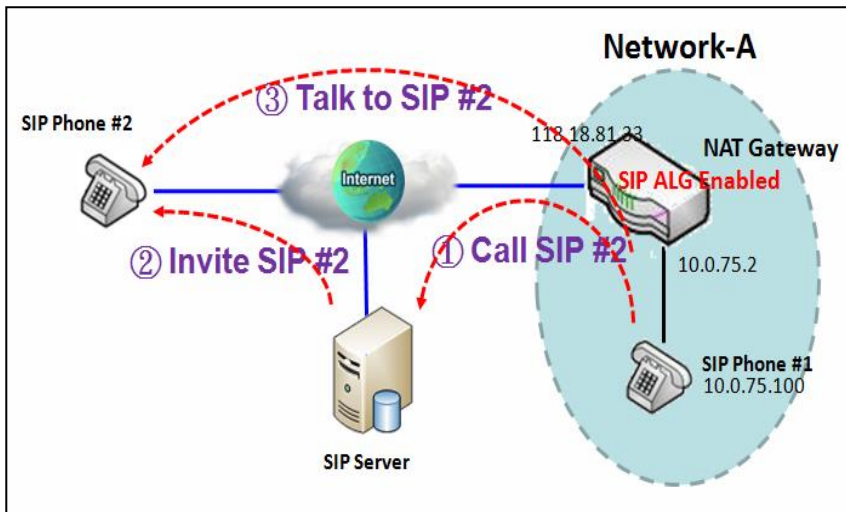

As shown in the diagram, the calling starts from the SIP Phone #1 to the SIP server via the NAT gateway. Then the SIP server invites the SIP Phone #2 and finally, the SIP Phone #1 talks to the SIP Phone #2. But for the NAT gateway, SIP Phone #2 is an unknown host, so the active access from the Phone #2 will be treated as unexpected traffic and will be blocked out. With the SIP ALG function enabled, the NAT gateway will monitor the control traffic for the SIP calls, and recognized the traffic from SIP Phone #2 is part of the connection sessions with SIP Phone #1.

### Special AP & ALG Setting

Go to **Basic Network > Port Forwarding > Special AP & ALG** tab.

The Special AP setting allows some applications require multiple connections. The ALG setting allows user to Support some SIP ALG, like STUN.

### Enable Special AP & ALG

| Configuration |   |
|---------------|---|
| Item          | Setting                                     |
| ▶ Special AP  | <input checked="" type="checkbox"/> Enable  |
| ▶ ALG Enable  | <input checked="" type="checkbox"/> SIP ALG |

| Configuration |                               |  |
|---------------|-------------------------------|--|
| Item          | Value setting                 | Description  |
| Special AP    | The box is checked by default | Check the <b>Enable</b> box to activate the Special AP function. |
| ALG Enable    | The box is checked by default | Check the <b>Enable</b> box to activate the SIP ALG function.    |
| Save          | N/A                           | Click the <b>Save</b> button to save the settings.               |
| Undo          | N/A                           | Click the <b>Undo</b> button to cancel the settings              |

## Create / Edit Special AP Rule

The gateway allows you to custom your Special AP rules. It supports up to a maximum of 8 rule-based Special AP sets.

| Special AP List <input type="button" value="Add"/> <input type="button" value="Delete"/> |               |              |                |               |        |         |
|--|---------------|--------------|----------------|---------------|--------|---------|
| ID   | WAN Interface | Trigger Port | Incoming Ports | Time Schedule | Enable | Actions |

When **Add** button is applied, **Special AP Rule Configuration** screen will appear.

| Special AP Rule Configuration <span style="float: right;">[ Help ]</span> |   |
|---|---|
| Item  | Setting   |
| ▶ WAN Interface   | <input checked="" type="checkbox"/> ALL <input type="checkbox"/> WAN-1 <input type="checkbox"/> WAN-2 |
| ▶ Trigger Port  | Port : <input type="text"/> Popular Applications : <input type="text" value="User-defined"/>          |
| ▶ Incoming Ports  | <input type="text"/>  |
| ▶ Time Schedule   | <input type="text" value="(0) Always"/>   |
| ▶ Rule  | <input type="checkbox"/>  |
| <input type="button" value="Save"/>                                       |   |

| IP Translation Configuration |  |  |
|------------------------------|--|--|
| Item                         | Value setting  | Description  |
| WAN Interface                | 1. A Must filled setting<br>2. <b>All</b> is checked by default.           | Check the interface box(es) to apply the Special AP rule.<br>By default, <b>All</b> is checked, and the Special AP rule will be applied to all WAN interfaces.   |
| Trigger Port                 | 1. A Must filled setting<br>2. <b>User-defined</b> is selected by default. | Enter the expected trigger port (or port range) if <b>User-defined</b> is selected in the dropdown list.<br>If you select other popular application from the dropdown list, the corresponding trigger port(s) and incoming ports will be defined automatically.<br><b>Value Range:</b> 1 ~ 65535.  |
| Incoming Ports               | 1. A Must filled setting   | Enter the expected Incoming ports if <b>User-defined</b> is selected in the Trigger Port dropdown list.<br>If you select other popular application from the dropdown list, the corresponding incoming ports will be defined automatically.<br><b>Value Range:</b> 1 ~ 65535; It can be a single port, multiple ports separated by “,”, .or port range. |
| Time Schedule                | 1. An Must filled setting<br>2. <b>(0) Always</b> is selected by default.  | Apply <b>Time Schedule</b> to this rule, otherwise leave it as Always.<br>If the dropdown list is empty ensure <b>Time Schedule</b> is pre-configured.<br>Refer to <b>Object Definition &gt; Scheduling &gt; Configuration</b> tab.  |
| Rule                         | The box is unchecked by default  | Check the <b>Enable</b> box to activate the special AP rule.   |
| Save                         | N/A  | Click the <b>Save</b> button to save the settings.   |
| Undo                         | N/A  | Click the <b>Undo</b> button to cancel the settings  |

### 2.6.4 DMZ & Pass Through

DMZ (De Militarized Zone) Host is a host that is exposed to the Internet cyberspace but still within the protection of firewall by router device. So, the function allows a computer to execute 2-way communication for Internet games, Video conferencing, Internet telephony and other special applications. In some cases when a specific application is blocked by NAT mechanism, you can indicate that LAN computer as a DMZ host to solve this problem.

| Configuration <span style="float: right;">[ Help ]</span> |   |
|---|---|
| Item  | Setting   |
| ▶ DMZ   | <input checked="" type="checkbox"/> Enable <input checked="" type="checkbox"/> All <input type="checkbox"/> WAN-1 <input type="checkbox"/> WAN-2<br>DMZ Host : <input type="text" value="10.0.75.100"/> |
| ▶ Pass Through Enable                                     | <input checked="" type="checkbox"/> IPSec <input checked="" type="checkbox"/> PPTP <input checked="" type="checkbox"/> L2TP   |

The DMZ function allows you to ask the router pass through all normal packets to the DMZ host behind the NAT router only when these packets are not expected to receive by applications in the router or by other client hosts in the Intranet. Certainly, the DMZ host is also protected by the router firewall. Activate the feature and specify the DMZ host with a host in the Intranet when needed.

### DMZ Scenario

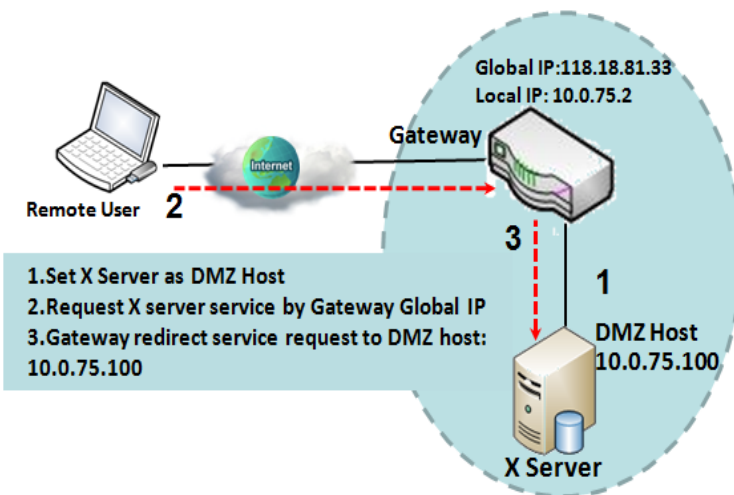

When the network administrator wants to set up some service daemons in a host behind NAT gateway to allow remote users request for services from server actively, you just have to configure this host as DMZ Host. As shown in the diagram, there is an X server installed as DMZ host, whose IP address is 10.0.75.100. Then, remote user can request services from X server just as it is provided by the gateway whose global IP address is 118.18.81.33. The gateway will forward those packets, not belonging to any configured virtual server or applications, directly to the DMZ host.

### VPN Pass through Scenario

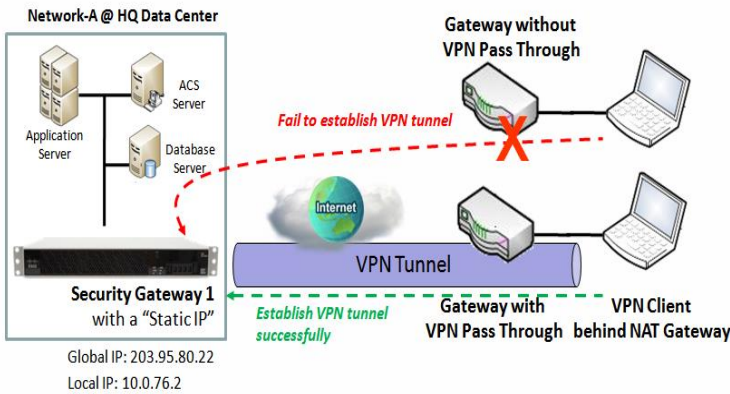

Since VPN traffic is different from that of TCP or UDP connection, it will be blocked by NAT gateway. To support the pass through function for the VPN connections initiating from VPN clients behind NAT gateway, the gateway must implement some kind of VPN pass through function for such application. The gateway support the pass through function for IPSec, PPTP, and L2TP connections, you just have to check the corresponding checkbox to activate it.

### DMZ & Pass Through Setting

Go to **Basic Network > Port Forwarding > DMZ & Pass Through** tab.

The DMZ host is a host that is exposed to the Internet cyberspace but still within the protection of firewall by router device.

### Enable DMZ and Pass Through

| Configuration [ Help ] |  |
|------------------------|--|
| Item                   | Setting  |
| DMZ                    | <input type="checkbox"/> Enable <input checked="" type="checkbox"/> All <input type="checkbox"/> WAN-1 <input type="checkbox"/> WAN-2<br>DMZ Host : <input type="text"/> |
| Pass Through Enable    | <input checked="" type="checkbox"/> IPSec <input checked="" type="checkbox"/> PPTP <input checked="" type="checkbox"/> L2TP  |

| Configuration |  |   |
|---------------|--|---|
| Item          | Value setting  | Description   |
| DMZ           | 1. A Must filled setting<br>2. Default is <b>ALL</b> . | Check the <b>Enable</b> box to activate the DMZ function<br>Define the selected interface to be the packet-entering interface of the router, and fill in the IP address of Host LAN IP in <b>DMZ Host</b> field.<br>If the packets to be filtered are coming from <b>WAN-x</b> then select <b>WAN-x</b> for this field.<br>Select <b>ALL</b> for packets coming into the router from any interfaces.<br>It can be selected <b>WAN-x</b> box when <b>WAN-x</b> enabled.<br><br><b>Note:</b> The available check boxes ( <b>WAN-1 ~ WAN-4</b> ) depend on the number of WAN interfaces for the product. |

|                            |                                  |  |
|----------------------------|----------------------------------|--|
| <b>Pass Through Enable</b> | The boxes are checked by default | Check the box to enable the pass through function for the <b>IPSec</b> , <b>PPTP</b> , and <b>L2TP</b> .<br>With the pass through function enabled, the VPN hosts behind the router still can connect to remote VPN servers. |
| <b>Save</b>                | N/A                              | Click the <b>Save</b> button to save the settings.   |
| <b>Undo</b>                | N/A                              | Click the <b>Undo</b> button to cancel the settings  |

## 2.7 Routing

The screenshot shows the router's web interface for configuring routing. On the left is a navigation menu with options like Status, Basic Network, WAN & Uplink, LAN & VLAN, WiFi, IPv6, Port Forwarding, Routing (selected), and DNS & DDNS. The main content area has three tabs: Static Routing, Dynamic Routing, and Routing Information. Under the Static Routing tab, there is a 'Configuration' section with a table:

| Item           | Setting                         |
|----------------|---------------------------------|
| Static Routing | <input type="checkbox"/> Enable |

Below this is an 'IPv4 Static Routing Rule List' section with 'Add' and 'Delete' buttons. It contains a table with the following columns: ID, Destination IP, Subnet Mask, Gateway IP, Interface, Metric, Enable, and Actions. At the bottom of the configuration area are 'Save' and 'Undo' buttons.

If you have more than one router and subnet, you will need to enable routing function to allow packets to find proper routing path and allow different subnets to communicate with each other. Routing is the process of selecting best paths in a network. It is performed for many kinds of networks, like electronic data networks (such as the Internet), by using packet switching technology. The routing process usually directs forwarding on the basis of routing tables which maintain a record of the routes to various network destinations. Thus, constructing routing tables, which are held in the router's memory, is very important for efficient routing. Most routing algorithms use only one network path at a time.

The routing tables record your pre-defined routing paths for some specific destination subnets. It is **static routing**. However, if the contents of routing tables record the obtained routing paths from neighbor routers by using some protocols, such as RIP, OSPF and BGP. It is **dynamic routing**. These both routing approaches will be illustrated one after one. In addition, the router also built in one advanced configurable routing software Quagga for more complex routing applications, you can configure it if required via Telnet CLI.

2.7.1 Static Routing

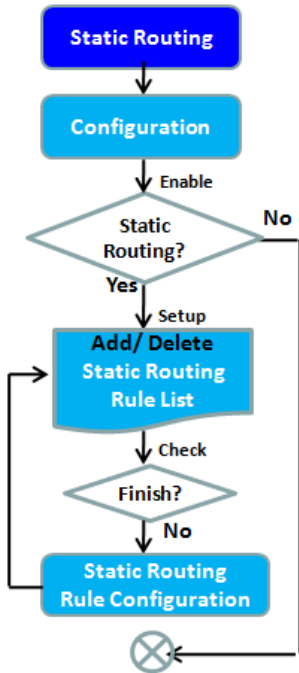

| Configuration [ Help ] |  |
|------------------------|--|
| Item                   | Setting                                    |
| Static Routing         | <input checked="" type="checkbox"/> Enable |

| IPv4 Static Routing Rule List [ Add ] [ Delete ] |                |             |            |           |        |        |         |
|--|----------------|-------------|------------|-----------|--------|--------|---------|
| ID   | Destination IP | Subnet Mask | Gateway IP | Interface | Metric | Enable | Actions |
|  |                |             |            |           |        |        |         |

| IPv4 Static Routing Rule Configuration |                                 |
|--|---------------------------------|
| Item                                   | Setting                         |
| Destination IP                         | <input type="text"/>            |
| Subnet Mask                            | 255.255.255.0 (/24) ▾           |
| Gateway IP                             | <input type="text"/>            |
| Interface                              | Auto ▾                          |
| Metric                                 | <input type="text"/>            |
| Rule                                   | <input type="checkbox"/> Enable |

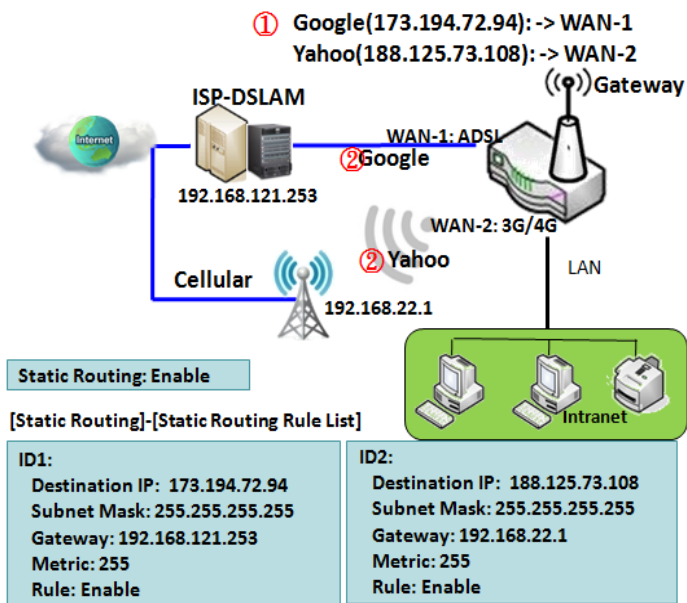

"Static Routing" function lets you define the routing paths for some dedicated hosts/servers or subnets to store in the routing table of the router. The router routes incoming packets to different peer gateways based on the routing table. You need to define the static routing information in gateway routing rule list.

When the administrator of the gateway wants to specify what kinds of packets to be transferred via which gateway interface and which peer gateway to their destination. It can be carried out by the "Static Routing" feature. Dedicated packet flows from the Intranet will be routed to their destination via the pre-defined peer gateway and corresponding gateway interface that are defined in the system routing table by manual.

As shown in the diagram, when the destination is Google access, rule 1 set interface as ADSL, routing gateway as IP-DSLAM gateway 192.168.121.253. All the packets to Google will go through WAN-1. And the same way applied to rule 2 of access Yahoo. Rule 2 sets 3G/4G as interface.

### Static Routing Setting

Go to **Basic Network > Routing > Static Routing** Tab.

There are three configuration windows for static routing feature, including "Configuration", "Static Routing Rule List" and "Static Routing Rule Configuration" windows. "Configuration" window lets you activate the global static routing feature. Even there are already routing rules, if you want to disable routing temporarily, just uncheck the Enable box to disable it. "Static Routing Rule List" window lists all your defined static routing rule entries. Using "Add" or "Edit" button to add and create one new static routing rule or to modify an existed one.

When "**Add**" or "**Edit**" button is applied, the "Static Routing Rule Configuration" window will appear to let you define a static routing rule.

### Enable Static Routing

Just check the **Enable** box to activate the "Static Routing" feature.

| <input type="checkbox"/> Configuration <span style="float: right;">[ Help ]</span> |  |
|--|--|
| Item   | Setting                                    |
| ▶ Static Routing   | <input checked="" type="checkbox"/> Enable |

| Static Routing |                                 |   |
|----------------|---------------------------------|---|
| Item           | Value setting                   | Description   |
| Static Routing | The box is unchecked by default | Check the <b>Enable</b> box to activate this function |

### Create / Edit Static Routing Rules

The Static Routing Rule List shows the setup parameters of all static routing rule entries. To configure a static routing rule, you must specify related parameters including the destination IP address and subnet mask of dedicated host/server or subnet, the IP address of peer gateway, the metric and the rule activation.

| <input type="checkbox"/> IPv4 Static Routing Rule List <input type="button" value="Add"/> <input type="button" value="Delete"/> |                |             |            |           |        |        |         |
|---|----------------|-------------|------------|-----------|--------|--------|---------|
| ID  | Destination IP | Subnet Mask | Gateway IP | Interface | Metric | Enable | Actions |

The router allows you to custom your static routing rules. It supports up to a maximum of 64 rule sets. When **Add** button is applied, **Static Routing Rule Configuration** screen will appear, while the **Edit** button at the end of each static routing rule can let you modify the rule.



| IPv4 Static Routing Rule Configuration |                                 |
|--|---------------------------------|
| Item                                   | Setting                         |
| ▶ Destination IP                       | <input type="text"/>            |
| ▶ Subnet Mask                          | 255.255.255.0 (/24) ▼           |
| ▶ Gateway IP                           | <input type="text"/>            |
| ▶ Interface                            | Auto ▼                          |
| ▶ Metric                               | <input type="text"/>            |
| ▶ Rule                                 | <input type="checkbox"/> Enable |

| IPv4 Static Routing   |  |  |
|-----------------------|--|--|
| Item                  | Value setting  | Description  |
| <b>Destination IP</b> | 1. IPv4 Format<br>2. A Must filled setting           | Specify the Destination IP of this static routing rule.  |
| <b>Subnet Mask</b>    | 255.255.255.0 (/24) is set by default                | Specify the Subnet Mask of this static routing rule.   |
| <b>Gateway IP</b>     | 1. IPv4 Format<br>2. A Must filled setting           | Specify the Gateway IP of this static routing rule.  |
| <b>Interface</b>      | Auto is set by default                               | Select the Interface of this static routing rule. It can be <b>Auto</b> , or the available WAN / LAN interfaces. |
| <b>Metric</b>         | 1. Numeric String Format<br>2. A Must filled setting | The Metric of this static routing rule.<br><i>Value Range: 0 ~ 255.</i>  |
| <b>Rule</b>           | The box is unchecked by default.                     | Click <b>Enable</b> box to activate this rule.   |
| <b>Save</b>           | NA   | Click the <b>Save</b> button to save the configuration   |
| <b>Undo</b>           | NA   | Click the <b>Undo</b> button to restore what you just configured back to the previous setting.                   |
| <b>Back</b>           | NA   | When the <b>Back</b> button is clicked the screen will return to the Static Routing Configuration page.          |

2.7.2 Dynamic Routing

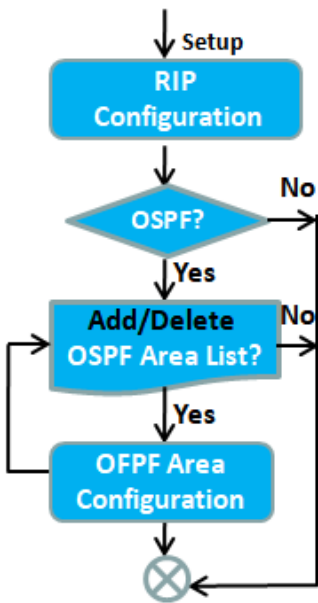

| RIP Configuration [ Help ]  |  |         |        |         |
|---|--|---------|--------|---------|
| Item  | Setting                                    |         |        |         |
| ▶ RIP Enable  | Disable ▾                                  |         |        |         |
| OSPF Configuration  |  |         |        |         |
| Item  | Setting                                    |         |        |         |
| ▶ OSPF  | <input checked="" type="checkbox"/> Enable |         |        |         |
| ▶ Router ID   | <input type="text"/>                       |         |        |         |
| ▶ Authentication  | None ▾                                     |         |        |         |
| ▶ Backbone Subnet   | <input type="text"/>                       |         |        |         |
| OSPF Area List <input type="button" value="Add"/> <input type="button" value="Delete"/> |  |         |        |         |
| ID  | Area Subnet                                | Area ID | Enable | Actions |
| OSPF Area Configuration   |  |         |        |         |
| Item  | Setting                                    |         |        |         |
| ▶ Area Subnet   | <input type="text"/>                       |         |        |         |
| ▶ Area ID   | <input type="text"/>                       |         |        |         |
| ▶ Area  | <input type="checkbox"/> Enable            |         |        |         |
| <input type="button" value="Save"/>   |  |         |        |         |

Dynamic Routing, also called adaptive routing, describes the capability of a system, through which routes are characterized by their destination, to alter the path that the route takes through the system in response to a change in network conditions.

This router supports dynamic routing protocols, including RIPv1/RIPv2 (Routing Information Protocol), and OSPF (Open Shortest Path First), for you to establish routing table automatically. The feature of dynamic routing will be very useful when there are lots of subnets in your network. Generally speaking, RIP is suitable for small network. OSPF is more suitable for medium network.

The supported dynamic routing protocols are described as follows:

## RIP Scenario

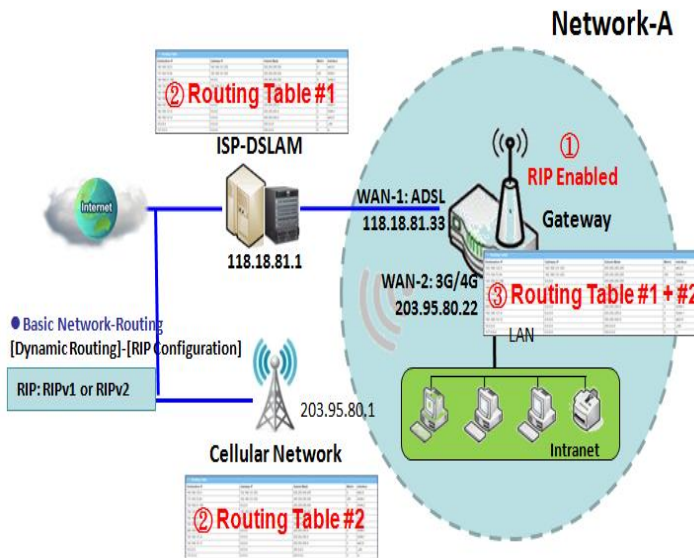

The Routing Information Protocol (RIP) is one of the oldest distance-vector routing protocols, which employs the hop count as a routing metric. RIP prevents routing loops by implementing a limit on the number of hops allowed in a path from the source to a destination. The maximum number of hops allowed for RIP is 15. This hop limit, however, also limits the size of networks that RIP can support. A hop count of 16 is considered an infinite distance, in other words the route is considered unreachable. RIP implements the split horizon, route poisoning and hold-down mechanisms to prevent incorrect routing information from being propagated.

## OSPF Scenario

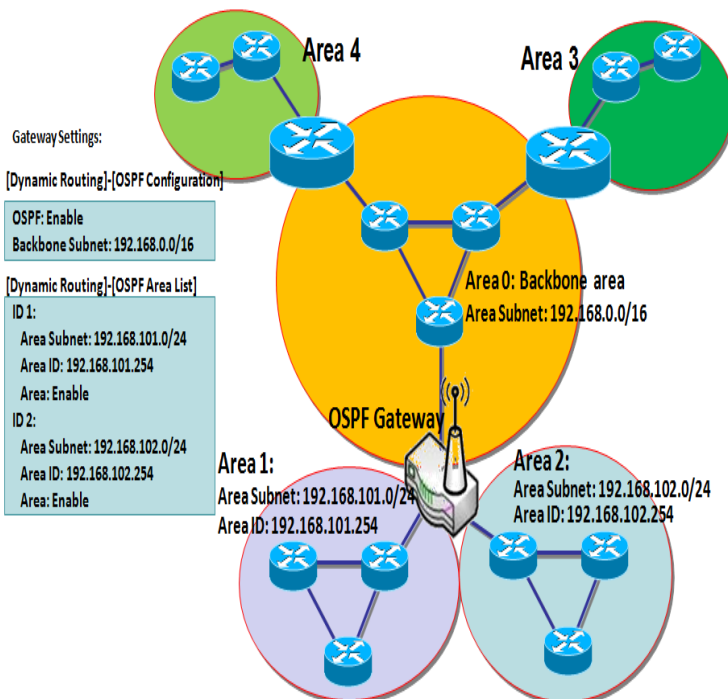

Open Shortest Path First (OSPF) is a routing protocol that uses link state routing algorithm. It is the most widely used interior gateway protocol (IGP) in large enterprise networks. It gathers link state information from available routers and constructs a topology map of the network. The topology is presented as a routing table which routes datagrams based solely on the destination IP address.

Network administrator can deploy OSPF gateway in large enterprise network to get its routing table from the enterprise backbone, and forward routing information to other routers, which are no linked to the enterprise backbone. Usually, an OSPF network is subdivided into routing areas to simplify administration and optimize traffic and resource utilization.

As shown in the diagram, OSPF gateway gathers routing information from the backbone gateways in area 0, and will forward its routing information to the routers in area 1 and area 2 which are not in the backbone.

## Dynamic Routing Setting

Go to **Basic Network > Routing > Dynamic Routing** Tab.

The dynamic routing setting allows user to customize RIP, and OSPF protocols through the router based on their office setting.

In the "Dynamic Routing" page, there are several configuration windows for dynamic routing feature. They are the "RIP Configuration" window, "OSPF Configuration" window, "OSPF Area List", and "OSPF Area Configuration" window. RIP, and OSPF protocols can be configured individually.

The "RIP Configuration" window lets you choose which version of RIP protocol to be activated or disable it. The "OSPF Configuration" window can let you activate the OSPF dynamic routing protocol and specify its backbone subnet. Moreover, the "OSPF Area List" window lists all defined areas in the OSPF network.

## RIP Configuration

The RIP configuration setting allows user to customize RIP protocol through the router based on their office setting.

| RIP Configuration <span style="float: right;">[ Help ]</span> |           |
|---|-----------|
| Item  | Setting   |
| ▶ RIP Enable  | Disable ▼ |

| RIP Configuration |                           |  |
|-------------------|---------------------------|--|
| Item              | Value setting             | Description  |
| RIP Enable        | Disable is set by default | Select <b>Disable</b> will disable RIP protocol.<br>Select <b>RIP v1</b> will enable RIPv1 protocol.<br>Select <b>RIP v2</b> will enable RIPv2 protocol. |

## OSPF Configuration

The OSPF configuration setting allows user to customize OSPF protocol through the router based on their office setting.

| OSPF Configuration |                                 |
|--------------------|---------------------------------|
| Item               | Setting                         |
| ▶ OSPF             | <input type="checkbox"/> Enable |
| ▶ Router ID        | <input type="text"/>            |
| ▶ Authentication   | None ▾                          |
| ▶ Backbone Subnet  | <input type="text"/>            |

| OSPF Configuration     |   |   |
|------------------------|---|---|
| Item                   | Value setting   | Description   |
| <b>OSPF</b>            | Disable is set by default   | Click <b>Enable</b> box to activate the OSPF protocol.  |
| <b>Router ID</b>       | 1. IPv4 Format<br>2. A Must filled setting  | The Router ID of this router on OSPF protocol   |
| <b>Authentication</b>  | None is set by default  | The Authentication method of this router on OSPF protocol.<br>Select <b>None</b> will disable Authentication on OSPF protocol.<br>Select <b>Text</b> will enable Text Authentication with entered the Key in this field on OSPF protocol.<br>Select <b>MD5</b> will enable MD5 Authentication with entered the ID and Key in these fields on OSPF protocol. |
| <b>Backbone Subnet</b> | 1. Classless Inter Domain Routing (CIDR) Subnet Mask Notation. (Ex: 192.168.1.0/24)<br>2. A Must filled setting | The Backbone Subnet of this router on OSPF protocol.  |

### Create / Edit OSPF Area Rules

The router allows you to custom your OSPF Area List rules. It supports up to a maximum of 32 rule sets.

| <input type="checkbox"/> OSPF Area List <input type="button" value="Add"/> <input type="button" value="Delete"/> |             |         |        |         |
|--|-------------|---------|--------|---------|
| ID   | Area Subnet | Area ID | Enable | Actions |

When **Add** button is applied, **OSPF Area Rule Configuration** screen will appear.

| <input type="checkbox"/> OSPF Area Configuration |                                 |
|--|---------------------------------|
| Item   | Setting                         |
| ▶ Area Subnet                                    | <input type="text"/>            |
| ▶ Area ID  | <input type="text"/>            |
| ▶ Area   | <input type="checkbox"/> Enable |
| <input type="button" value="Save"/>              |                                 |

| OSPF Area Configuration |   |  |
|-------------------------|---|--|
| Item                    | Value setting   | Description  |
| <b>Area Subnet</b>      | 1. Classless Inter Domain Routing (CIDR) Subnet Mask Notation. (Ex: 192.168.1.0/24)<br>2. A Must filled setting | The Area Subnet of this router on OSPF Area List.      |
| <b>Area ID</b>          | 1. IPv4 Format<br>2. A Must filled setting  | The Area ID of this router on OSPF Area List.          |
| <b>Area</b>             | The box is unchecked by default.  | Click <b>Enable</b> box to activate this rule.         |
| <b>Save</b>             | N/A   | Click the <b>Save</b> button to save the configuration |

### 2.7.3 Routing Information

The routing information allows user to view the routing table and policy routing information.

Go to **Basic Network > Routing > Routing Information Tab.**

| Routing Table  |                 |            |        |           |
|----------------|-----------------|------------|--------|-----------|
| Destination IP | Subnet Mask     | Gateway IP | Metric | Interface |
| 10.177.141.44  | 255.255.255.252 | 0.0.0.0    | 0      | WAN-1     |
| 192.168.123.0  | 255.255.255.0   | 0.0.0.0    | 0      | LAN       |
| 169.254.0.0    | 255.255.0.0     | 0.0.0.0    | 0      | LAN       |
| 118.0.0.0      | 255.0.0.0       | 0.0.0.0    | 0      | WAN-1     |
| 127.0.0.0      | 255.0.0.0       | 0.0.0.0    | 0      | lo        |

| Routing Table  |               |  |
|----------------|---------------|--|
| Item           | Value setting | Description                                      |
| Destination IP | N/A           | Routing record of Destination IP. IPv4 Format.   |
| Subnet Mask    | N/A           | Routing record of Subnet Mask. IPv4 Format.      |
| Gateway IP     | N/A           | Routing record of Gateway IP. IPv4 Format.       |
| Metric         | N/A           | Routing record of Metric. Numeric String Format. |
| Interface      | N/A           | Routing record of Interface Type. String Format. |

## 2.8 DNS & DDNS

How does user access your server if your WAN IP address changes all the time? One way is to register a new domain name, and maintain your own DNS server. Another simpler way is to apply a domain name to a third-party DDNS service provider. The service can be free or charged. If you want to understand the basic concepts of DNS and Dynamic DNS, you can refer to Wikipedia website<sup>1</sup>.

### 2.8.1 DNS & DDNS Configuration

#### Dynamic DNS

To host your server on a changing IP address, you have to use dynamic domain name service (DDNS). Therefore, anyone wishing to reach your host only needs to know the domain name. Dynamic DNS will map the name of your host to your current IP address, which changes each time you connect your Internet service provider.

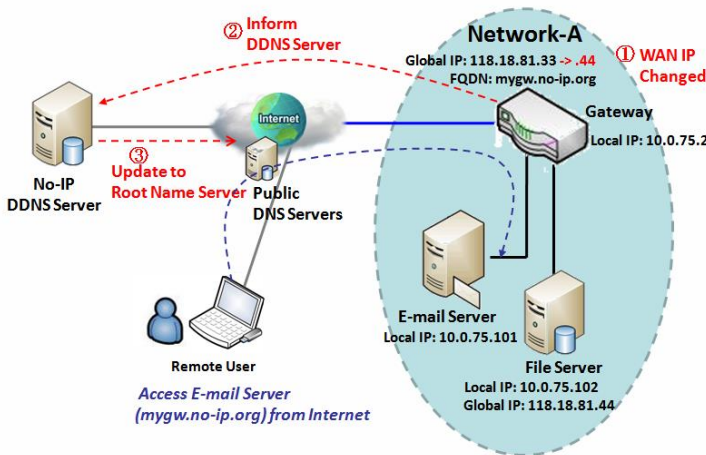

The Dynamic DNS service allows the gateway to alias a public dynamic IP address to a static domain name, allowing the gateway to be more easily accessed from various locations on the Internet. As shown in the diagram, user registered a domain name to a third-party DDNS service provider (NO-IP) to use DDNS function. Once the IP address of designated WAN interface has changed, the dynamic DNS agent in the gateway will inform the DDNS server with the new IP address. The server automatically re-maps your domain name with the changed IP address. So, other hosts or remote users in the Internet world are able to link to your gateway by using your domain name regardless of the changing global IP address.

<sup>1</sup> [http://en.wikipedia.org/wiki/Domain\\_Name\\_System](http://en.wikipedia.org/wiki/Domain_Name_System), [http://en.wikipedia.org/wiki/Dynamic\\_DNS](http://en.wikipedia.org/wiki/Dynamic_DNS)



## DNS & DDNS Setting

Go to **Basic Network > DNS & DDNS > Configuration** Tab.

The DNS & DDNS setting allows user to setup Dynamic DNS feature and DNS redirect rules.

### Setup Dynamic DNS

The router allows you to custom your Dynamic DNS settings.

| Dynamic DNS [ Help ] |                                 |
|----------------------|---------------------------------|
| Item                 | Setting                         |
| ▶ DDNS               | <input type="checkbox"/> Enable |
| ▶ WAN Interface      | WAN-1 ▼                         |
| ▶ Provider           | DynDNS.org(Dynamic) ▼           |
| ▶ Host Name          | <input type="text"/>            |
| ▶ User Name / E-Mail | <input type="text"/>            |
| ▶ Password / Key     | <input type="text"/>            |

| DDNS (Dynamic DNS) Configuration |  |  |
|----------------------------------|--|--|
| Item                             | Value setting  | Description  |
| DDNS                             | The box is unchecked by default                              | Check the <b>Enable</b> box to activate this function.   |
| WAN Interface                    | WAN 1 is set by default                                      | Select the WAN Interface IP Address of the router.   |
| Provider                         | <b>DynDNS.org (Dynamic)</b> is set by default                | Select your DDNS provider of Dynamic DNS. It can be <b>DynDNS.org(Dynamic)</b> , <b>DynDNS.org(Custom)</b> , <b>NO-IP.com</b> , etc... |
| Host Name                        | 1. String format can be any text<br>2. A Must filled setting | Your registered host name of Dynamic DNS.<br><b>Value Range: 0 ~ 63 characters.</b>  |
| User Name / E-Mail               | 1. String format can be any text<br>2. A Must filled setting | Enter your User name or E-mail address of Dynamic DNS.   |
| Password / Key                   | 1. String format can be any text<br>2. A Must filled setting | Enter your Password or Key of Dynamic DNS.   |
| Save                             | N/A  | Click <b>Save</b> to save the settings   |
| Undo                             | N/A  | Click <b>Undo</b> to cancel the settings   |

### Setup DNS Redirect

DNS redirect is a special function to redirect certain traffics to a specified host. Administrator can manage the internet / intranet traffics that are going to access some restricted DNS and force those traffics to be redirected to a specified host.

| <input type="checkbox"/> DNS Redirect |                                 |
|---------------------------------------|---------------------------------|
| Item                                  | Setting                         |
| <input type="checkbox"/> DNS Redirect | <input type="checkbox"/> Enable |

| DNS Redirect Configuration |                                 |  |
|----------------------------|---------------------------------|--|
| Item                       | Value setting                   | Description  |
| DNS Redirect               | The box is unchecked by default | Check the <b>Enable</b> box to activate this function. |
| Save                       | N/A                             | Click <b>Save</b> to save the settings                 |
| Undo                       | N/A                             | Click <b>Undo</b> to cancel the settings               |

If you enabled the DNS Redirect function, you have to further specify the redirect rules. According to the rules, the router can redirect the traffic that matched the DNS to corresponding pre-defined IP address.

| <input type="checkbox"/> Redirect Rule <input type="button" value="Add"/> <input type="button" value="Delete"/> |              |           |             |        |        |
|---|--------------|-----------|-------------|--------|--------|
| ID  | Mapping Rule | Condition | Description | Enable | Action |

When **Add** button is applied, **Redirect Rule** screen will appear.

| <input type="checkbox"/> Redirect Rule <input type="button" value="Save"/> <input type="button" value="Back"/> |  |             |    |                                  |                      |
|--|--|-------------|----|----------------------------------|----------------------|
| Item   | Setting  |             |    |                                  |                      |
| Mapping Rule   | <table border="1"> <tr> <th>Domain Name</th> <th>IP</th> </tr> <tr> <td> <input type="text"/> (* for Any)           </td> <td> <input type="text"/> </td> </tr> </table> | Domain Name | IP | <input type="text"/> (* for Any) | <input type="text"/> |
|  | Domain Name  | IP          |    |                                  |                      |
| <input type="text"/> (* for Any)   | <input type="text"/>   |             |    |                                  |                      |
| Condition  | <input type="text" value="Always"/>  |             |    |                                  |                      |
| Description  | <input type="text"/>   |             |    |                                  |                      |
| Enable   | <input type="checkbox"/> Enable  |             |    |                                  |                      |

| Redirect Rule Configuration |  |   |
|-----------------------------|--|---|
| Item                        | Value setting  | Description   |
| <b>Domain Name</b>          | 1. String format can be any text<br>2. A Must filled setting         | Enter a domain name to be redirect. The traffic to specified domain name will be redirect to the following IP address.<br><b>Value Range:</b> at least 1 character is required; '*' for any.  |
| <b>IP</b>                   | 1. IPv4 format<br>2. A Must filled setting                           | Enter an IP Address as the target for the DNS redirect.   |
| <b>Condition</b>            | 1. A Must filled setting<br>2. <b>Always is selected by default.</b> | Specify when the DNS redirect action can be applied.<br>It can be <b>Always</b> , or <b>WAN Block</b> .<br><b>Always:</b> The DNS redirect function can be applied to the matched DNS all the time.<br><b>WAN Block:</b> The DNS redirect function can be applied to the matched DNS only when the WAN connection is disconnected, or un-reachable. |
| <b>Description</b>          | 1. String format can be any text<br>2. A Must filled setting         | Enter a brief description for this rule.<br><b>Value Range:</b> 0 ~ 63 characters.  |
| <b>Enable</b>               | The box is unchecked by default                                      | Click the <b>Enable</b> button to activate this rule.   |
| <b>Save</b>                 | N/A  | Click <b>Save</b> to save the settings  |
| <b>Undo</b>                 | N/A  | Click <b>Undo</b> to cancel the settings  |

### 3. Object Definition

#### 3.1 Scheduling

Scheduling provides ability of adding/deleting time schedule rules, which can be applied to other functionality.

##### 3.1.1 Scheduling Configuration

Go to **Object Definition > Scheduling > Configuration** tab.

| <input type="checkbox"/> Time Schedule List <input type="button" value="Add"/> <input type="button" value="Delete"/> |           |         |
|--|-----------|---------|
| ID   | Rule Name | Actions |

| Button description |               |   |
|--------------------|---------------|---|
| Item               | Value setting | Description   |
| Add                | N/A           | Click the <b>Add</b> button to configure time schedule rule |
| Delete             | N/A           | Click the <b>Delete</b> button to delete selected rule(s)   |

When **Add** button is applied, Time Schedule Configuration and Time Period Definition screens will appear.

| <input type="checkbox"/> Time Schedule Configuration |  |
|--|--|
| Item   | Setting  |
| ▶ Rule Name  | <input type="text"/>   |
| ▶ Rule Policy  | <input type="button" value="Inactivate"/> the Selected Days and Hours Below. |

| Time Schedule Configuration |                    |   |
|-----------------------------|--------------------|---|
| Item                        | Value Setting      | Description   |
| Rule Name                   | String: any text   | Set rule name   |
| Rule Policy                 | Default Inactivate | Inactivate/activate the function been applied to in the time period below |

| Time Period Definition |                    |                      |                      |
|------------------------|--------------------|----------------------|----------------------|
| ID                     | Week Day           | Start Time (hh:mm)   | End Time (hh:mm)     |
| 1                      | -- choose one -- ▼ | <input type="text"/> | <input type="text"/> |
| 2                      | -- choose one -- ▼ | <input type="text"/> | <input type="text"/> |
| 3                      | -- choose one -- ▼ | <input type="text"/> | <input type="text"/> |
| 4                      | -- choose one -- ▼ | <input type="text"/> | <input type="text"/> |
| 5                      | -- choose one -- ▼ | <input type="text"/> | <input type="text"/> |
| 6                      | -- choose one -- ▼ | <input type="text"/> | <input type="text"/> |
| 7                      | -- choose one -- ▼ | <input type="text"/> | <input type="text"/> |
| 8                      | -- choose one -- ▼ | <input type="text"/> | <input type="text"/> |

| Time Period Definition |                     |  |
|------------------------|---------------------|--|
| Item                   | Value Setting       | Description  |
| <b>Week Day</b>        | Select from menu    | Select everyday or one of weekday                                  |
| <b>Start Time</b>      | Time format (hh:mm) | Start time in selected weekday                                     |
| <b>End Time</b>        | Time format (hh:mm) | End time in selected weekday                                       |
| <b>Save</b>            | N/A                 | Click <b>Save</b> to save the settings                             |
| <b>Undo</b>            | N/A                 | Click <b>Undo</b> to cancel the settings                           |
| <b>Refresh</b>         | N/A                 | Click the <b>Refresh</b> button to refresh the time schedule list. |

### 3.2 External Server

Go to **Object Definition > External Server > External Server** tab.

The External Server setting allows user to add external server.

| External Server List <input type="button" value="Add"/> <input type="button" value="Delete"/> |             |             |                |             |               |         |
|---|-------------|-------------|----------------|-------------|---------------|---------|
| ID  | Server Name | Server Type | Server IP/FQDN | Server Port | Server Enable | Actions |

When **Add** button is applied, **External Server Configuration** screen will appear.

| External Server Configuration   |  |
|---|--|
| Item  | Setting  |
| ▶ Server Name   | <input type="text"/>   |
| ▶ Server Type   | Email Server <input type="button" value="v"/><br>User Name: <input type="text"/><br>Password: <input type="text"/> |
| ▶ Server IP/FQDN  | <input type="text"/>   |
| ▶ Server Port   | <input type="text" value="25"/>  |
| ▶ Server  | <input checked="" type="checkbox"/> Enable   |
| <input type="button" value="Save"/> <input type="button" value="Undo"/> |  |

| External Server Configuration |  |  |
|-------------------------------|--|--|
| Item                          | Value setting  | Description  |
| Sever Name                    | 1. String format can be any text<br>2. A Must filled setting | Enter a server name. Enter a name that is easy for you to understand.  |
| Server Type                   | A Must filled setting  | <p>Specify the Server Type of the external server, and enter the required settings for the accessing the server.</p> <p><b>Email Server</b> (A Must filled setting) :<br/>When <b>Email Server</b> is selected, <b>User Name</b>, and <b>Password</b> are also required.<br/><b>User Name</b> (String format: any text)<br/><b>Password</b> (String format: any text)</p> <p><b>Syslog Server</b></p> <p><b>RADIUS Server</b> (A Must filled setting) :<br/>When <b>RADIUS Server</b> is selected, the following settings are also required.<br/>Primary :<br/><b>Shared Key</b> (String format: any text)<br/>Authentication Protocol (By default CHAP is selected)<br/>Session Timeout (By default <b>1</b>)<br/>The values must be between 1 and 60.<br/>Idle Timeout: (By default <b>1</b>)<br/>The values must be between 1 and 15.<br/>Secondary :<br/><b>Shared Key</b> (String format: any text)<br/>Authentication Protocol (By default CHAP is selected)<br/>Session Timeout (By default <b>1</b>)<br/>The values must be between 1 and 60.<br/>Idle Timeout: (By default <b>1</b>)<br/>The values must be between 1 and 15.</p> |
| Server IP/FQDN                | A Must filled setting  | Specify the IP address or FQDN used for the external server.   |
| Server Port                   | A Must filled setting  | <p>Specify the Port used for the external server. If you selected a certain server type, the default server port number will be set.</p> <p>For <b>Email Server</b> 25 will be set by default;<br/>For <b>Syslog Server</b>, port 514 will be set by default;<br/>For <b>RADIUS Server</b>, port 1812 will be set by default;<br/><b>Value Range: 1 ~ 65535.</b></p>   |
| Account Port                  | 1. A Must filled setting<br>2. <b>1813 is set by default</b> | <p>Specify the accounting port used if you selected external RADIUS server.<br/><b>Value Range: 1 ~ 65535.</b></p>   |
| Server                        | The box is checked by default                                | Click <b>Enable</b> to activate this External Server.  |
| Save                          | N/A  | Click <b>Save</b> to save the settings   |
| Undo                          | N/A  | Click <b>Undo</b> to cancel the settings   |
| Refresh                       | N/A  | Click the <b>Refresh</b> button to refresh the external server list.   |

### 3.3 Certificate

In cryptography, a public key certificate (also known as a digital certificate or identity certificate) is an electronic document used to prove ownership of a public key. The certificate includes information about the key, information about its owner's identity, and the digital signature of an entity that has verified the certificate's contents are genuine. If the signature is valid, and the person examining the certificate trusts the signer, then they know they can use that key to communicate with its owner<sup>1</sup>.

In a typical public-key infrastructure (PKI) scheme, the signer is a certificate authority (CA), usually a company such as VeriSign which charges customers to issue certificates for them. In a web of trust scheme, the signer is either the key's owner (a self-signed certificate) or other users ("endorsements") whom the person examining the certificate might know and trust. The device also plays as a CA role.

Certificates are an important component of Transport Layer Security (TLS, sometimes called by its older name SSL), where they prevent an attacker from impersonating a secure website or other server. They are also used in other important applications, such as email encryption and code signing. Here, it can be used in IPSec tunneling for user authentication.

#### 3.3.1 My Certificate

My Certificate includes a Local Certificate List. Local Certificate List shows all generated certificates by the root CA for the router. And it also stores the generated Certificate Signing Requests (CSR) which will be signed by other external CAs. The signed certificates can be imported as the local ones of the router.

#### Self-signed Certificate Usage Scenario

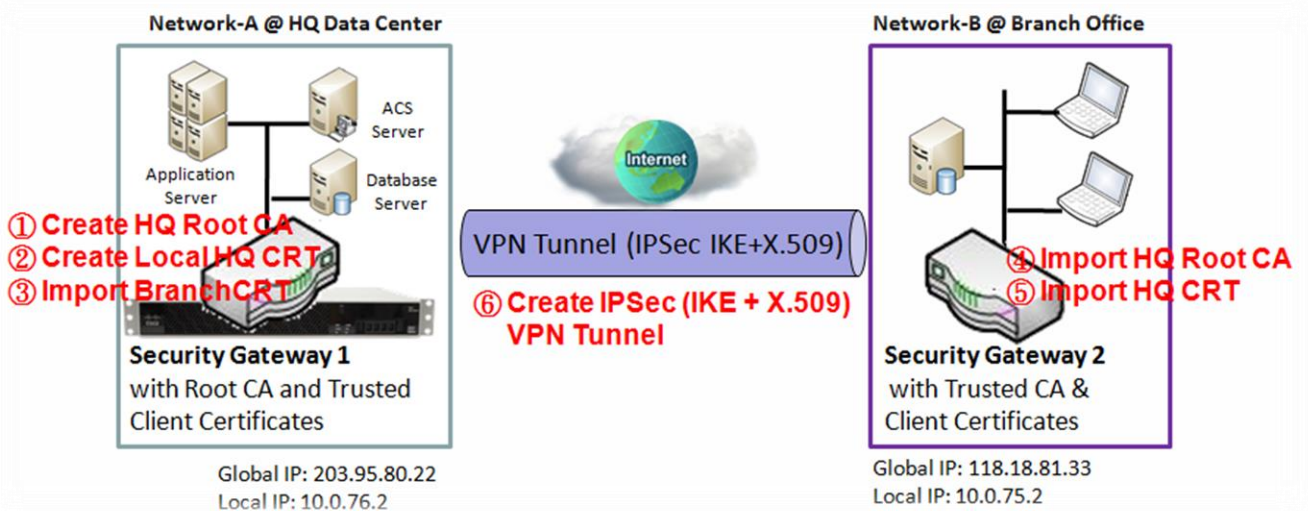

#### Scenario Application Timing

- When the enterprise router owns the root CA and VPN tunneling function, it can generate its own local certificates by being signed by itself or import any local certificates that are signed by other external CAs.
- Also import the trusted certificates for other CAs and Clients. In addition, since it has the root CA, it also

<sup>1</sup> [http://en.wikipedia.org/wiki/Public\\_key\\_certificate](http://en.wikipedia.org/wiki/Public_key_certificate)



can sign Certificate Signing Requests (CSR) to form corresponding certificates for others.

- These certificates can be used for two remote peers to make sure their identity during establishing a VPN tunnel.

### Scenario Description

- Gateway 1 generates the root CA and a local certificate (HQCRT) signed by itself. Import a trusted certificate (BranchCRT) –a BranchCSR certificate of Gateway 2 signed by root CA of Gateway 1.
- Gateway 2 creates a CSR (BranchCSR) to let the root CA of the Gateway 1 sign it to be the BranchCRT certificate. Import the certificate into the Gateway 2 as a local certificate. In addition, also import the certificates of the root CA of the Gateway 1 into the Gateway 2 as the trusted ones. (Please also refer to following two sub-sections.)
- Establish an IPsec VPN tunnel with IKE and X.509 protocols by starting from either peer, so that all client hosts in these both subnets can communicate with each other.

### Parameter Setup Example

#### For Network-A at HQ

- Following tables list the parameter configuration as an example for the "My Certificate" function used in the user authentication of IPsec VPN tunnel establishing, as shown in above diagram.
- The configuration example must be combined with the ones in following two sections to complete the whole user scenario.
- Use default value for those parameters that are not mentioned in the tables.

| Configuration Path | [My Certificate]-[Root CA Certificate Configuration]   |
|--------------------|--|
| Name               | <i>HQRootCA</i>  |
| Key                | Key Type: <i>RSA</i> Key Length: <i>1024-bits</i>  |
| Subject Name       | Country(C): <i>TW</i> State(ST): <i>Taiwan</i> Location(L): <i>Tainan</i><br>Organization(O): <i>AMITHQ</i> Organization Unit(OU): <i>HQRD</i><br>Common Name(CN): <i>HQRootCA</i> E-mail: <i>hqrootca@amit.com.tw</i> |

| Configuration Path | [My Certificate]-[Local Certificate Configuration]  |
|--------------------|---|
| Name               | <i>HQCRT</i> Self-signed: <input checked="" type="checkbox"/>   |
| Key                | Key Type: <i>RSA</i> Key Length: <i>1024-bits</i>   |
| Subject Name       | Country(C): <i>TW</i> State(ST): <i>Taiwan</i> Location(L): <i>Tainan</i><br>Organization(O): <i>AMITHQ</i> Organization Unit(OU): <i>HQRD</i><br>Common Name(CN): <i>HQCRT</i> E-mail: <i>hqcert@amit.com.tw</i> |

| Configuration Path | [IPSec]-[Configuration] |
|--------------------|-------------------------|
| IPSec              | ■ <i>Enable</i>         |

| Configuration Path | [IPSec]-[Tunnel Configuration] |
|--------------------|--------------------------------|
| Tunnel             | ■ <i>Enable</i>                |
| Tunnel Name        | <i>s2s-101</i>                 |
| Interface          | <i>WAN 1</i>                   |
| Tunnel Scenario    | <i>Site to Site</i>            |
| Operation Mode     | <i>Always on</i>               |

| Configuration Path | [IPSec]-[Local & Remote Configuration] |
|--------------------|--|
| Local Subnet       | <i>10.0.76.0</i>                       |
| Local Netmask      | <i>255.255.255.0</i>                   |
| Full Tunnel        | <i>Disable</i>                         |
| Remote Subnet      | <i>10.0.75.0</i>                       |
| Remote Netmask     | <i>255.255.255.0</i>                   |
| Remote Gateway     | <i>118.18.81.33</i>                    |

| Configuration Path | [IPSec]-[Authentication]  |
|--------------------|---|
| Key Management     | <i>IKE+X.509</i> Local Certificate: <i>HQCRT</i> Remote Certificate: <i>BranchCRT</i> |
| Local ID           | <i>User Name Network-A</i>  |
| Remote ID          | <i>User Name Network-B</i>  |

| Configuration Path | [IPSec]-[IKE Phase] |
|--------------------|---------------------|
| Negotiation Mode   | <i>Main Mode</i>    |
| X-Auth             | <i>None</i>         |

### For Network-B at Branch Office

- Following tables list the parameter configuration as an example for the "My Certificate" function used in the user authentication of IPSec VPN tunnel establishing, as shown in above diagram.
- The configuration example must be combined with the ones in following two sections to complete the whole user scenario.
- Use default value for those parameters that are not mentioned in the tables.

| Configuration Path | [My Certificate]-[Local Certificate Configuration]   |
|--------------------|--|
| Name               | <i>BranchCRT</i> Self-signed: <input type="checkbox"/>   |
| Key                | Key Type: <i>RSA</i> Key Length: <i>1024-bits</i>  |
| Subject Name       | Country(C): <i>TW</i> State(ST): <i>Taiwan</i> Location(L): <i>Tainan</i><br>Organization(O): <i>AMITBranch</i> Organization Unit(OU): <i>BranchRD</i><br>Common Name(CN): <i>BranchCRT</i> E-mail: <i>branchcrt@amit.com.tw</i> |

| Configuration Path | [IPSec]-[Configuration] |
|--------------------|-------------------------|
| IPSec              | ■ <i>Enable</i>         |

| Configuration Path | [IPSec]-[Tunnel Configuration] |
|--------------------|--------------------------------|
| Tunnel             | ■ <i>Enable</i>                |
| Tunnel Name        | <i>s2s-102</i>                 |
| Interface          | <i>WAN 1</i>                   |
| Tunnel Scenario    | <i>Site to Site</i>            |
| Operation Mode     | <i>Always on</i>               |

| Configuration Path | [IPSec]-[Local & Remote Configuration] |
|--------------------|--|
| Local Subnet       | <i>10.0.75.0</i>                       |
| Local Netmask      | <i>255.255.255.0</i>                   |
| Full Tunnel        | <i>Disable</i>                         |
| Remote Subnet      | <i>10.0.76.0</i>                       |
| Remote Netmask     | <i>255.255.255.0</i>                   |
| Remote Gateway     | <i>203.95.80.22</i>                    |

| Configuration Path | [IPSec]-[Authentication]  |
|--------------------|---|
| Key Management     | <i>IKE+X.509</i> Local Certificate: <i>BranchCRT</i> Remote Certificate: <i>HQCRT</i> |
| Local ID           | <i>User Name Network-B</i>  |
| Remote ID          | <i>User Name Network-A</i>  |

| Configuration Path | [IPSec]-[IKE Phase] |
|--------------------|---------------------|
| Negotiation Mode   | <i>Main Mode</i>    |
| X-Auth             | <i>None</i>         |

### Scenario Operation Procedure

- In above diagram, "Gateway 1" is the gateway of Network-A in headquarters and the subnet of its Intranet is 10.0.76.0/24. It has the IP address of 10.0.76.2 for LAN interface and 203.95.80.22 for WAN-1 interface. "Gateway 2" is the gateway of Network-B in branch office and the subnet of its Intranet is 10.0.75.0/24. It has the IP address of 10.0.75.2 for LAN interface and 118.18.81.33 for WAN-1 interface. They both serve as the NAT security gateways.
- Gateway 1 generates the root CA and a local certificate (HQCRT) that is signed by itself. Import the certificates of the root CA and HQCRT into the "Trusted CA Certificate List" and "Trusted Client Certificate List" of Gateway 2.
- Gateway 2 generates a Certificate Signing Request (BranchCSR) for its own certificate (BranchCRT) (Please generate one not self-signed certificate in the Gateway 2, and click on the "View" button for that CSR. Just downloads it). Take the CSR to be signed by the root CA of Gateway 1 and obtain the BranchCRT certificate (you need rename it). Import the certificate into the "Trusted Client Certificate List" of the Gateway 1 and the "Local Certificate List" of Gateway 2.
- Gateway 2 can establish an IPSec VPN tunnel with "Site to Site" scenario and IKE and X.509 protocols to Gateway 1.
- Finally, the client hosts in two subnets of 10.0.75.0/24 and 10.0.76.0/24 can communicate with each other.

### My Certificate Setting

Go to **Object Definition > Certificate > My Certificate** tab.

The My Certificate setting allows user to create local certificates. In "My Certificate" page, there are two configuration windows for the "My Certificate" function. The "Local Certificate List" window shows the stored certificates or CSRs for representing the gateway. The "Local Certificate Configuration" window can let you fill required information necessary for corresponding certificate to be generated by itself, or corresponding CSR to be signed by other CAs.

### Create Local Certificate

| <input type="checkbox"/> Local Certificate List <input type="button" value="Add"/> <input type="button" value="Import"/> <input type="button" value="Delete"/> |      |         |        |          |         |
|--|------|---------|--------|----------|---------|
| ID   | Name | Subject | Issuer | Vaild To | Actions |

When **Add** button is applied, **Local Certificate Configuration** screen will appear. The required information to be filled for the certificate or CSR includes the name, key and subject name. It is a certificate if the "Self-signed" box is checked; otherwise, it is a CSR.

| <input type="checkbox"/> Local Certificate Configuration |   |
|--|---|
| Item   | Setting   |
| ▶ Name   | <input type="text"/> Self-signed : <input type="checkbox"/>   |
| ▶ Key  | Key Type : <input type="text" value="RSA"/> Key Length : <input type="text" value="1024-bits"/> Digest Algorithm : <input type="text" value="SHA-1"/>   |
| ▶ Subject Name   | Country(C) : <input type="text"/> State(ST) : <input type="text"/> Location(L) : <input type="text"/><br>Organization(O) : <input type="text"/> Organization Unit(OU) : <input type="text"/><br>Common Name(CN) : <input type="text"/> Email : <input type="text"/> |
| ▶ Extra Attributes                                       | Challenge Password: <input type="text"/> Unstructured Name: <input type="text"/>  |

| Local Certificate Configuration |  |  |
|---------------------------------|--|--|
| Item                            | Value setting  | Description  |
| <b>Name</b>                     | 1. String format can be any text<br>2. A Must filled setting | Enter a certificate name. It will be a certificate file name<br>If <b>Self-signed</b> is checked, it will be signed by root CA. If <b>Self-signed</b> is not checked, it will generate a certificate signing request (CSR).  |
| <b>Key</b>                      | A Must filled setting  | This field is to specify the key attributes of certificate.<br><b>Key Type</b> to set public-key cryptosystems. Currently, only RSA is supported.<br><b>Key Length</b> to set the length in bits of the key used in a cryptographic algorithm. It can be 512/768/1024/1536/2048.<br><b>Digest Algorithm</b> to set identifier in the signature algorithm identifier of certificates. It can be MD5/SHA-1.  |
| <b>Subject Name</b>             | A Must filled setting  | This field is to specify the information of certificate.<br><b>Country(C)</b> is the two-letter ISO code for the country where your organization is located.<br><b>State(ST)</b> is the state where your organization is located.<br><b>Location(L)</b> is the location where your organization is located.<br><b>Organization(O)</b> is the name of your organization.<br><b>Organization Unit(OU)</b> is the name of your organization unit.<br><b>Common Name(CN)</b> is the name of your organization.<br><b>Email</b> is the email of your organization. It has to be email address setting only. |
| <b>Extra Attributes</b>         | A Must filled setting  | This field is to specify the extra information for generating a certificate.<br><b>Challenge Password</b> for the password you can use to request certificate revocation in the future.<br><b>Unstructured Name</b> for additional information.  |
| <b>Save</b>                     | N/A  | Click the <b>Save</b> button to save the configuration.  |
| <b>Back</b>                     | N/A  | When the <b>Back</b> button is clicked, the screen will return to previous page.   |

When **Import** button is applied, an Import screen will appear. You can import a certificate from an existed certificate file, or directly paste a PEM encoded string as the certificate.

Import

No file chosen

---

PEM Encoded

| Import      |  |   |
|-------------|--|---|
| Item        | Value setting  | Description   |
| Import      | A Must filled setting  | Select a certificate file from user's computer, and click the <b>Apply</b> button to import the specified certificate file to the router.   |
| PEM Encoded | 1. String format can be any text<br>2. A Must filled setting | This is an alternative approach to import a certificate. You can directly fill in (Copy and Paste) the PEM encoded certificate string, and click the <b>Apply</b> button to import the specified certificate to the router. |
| Apply       | N/A  | Click the <b>Apply</b> button to import the certificate.  |
| Cancel      | N/A  | Click the <b>Cancel</b> button to discard the import operation and the screen will return to the My Certificates page.  |

### 3.3.2 Trusted Certificate

Trusted Certificate includes Trusted CA Certificate List, Trusted Client Certificate List, and Trusted Client Key List. The Trusted CA Certificate List places the certificates of external trusted CAs. The Trusted Client Certificate List places the others' certificates what you trust. And the Trusted Client Key List places the others' keys what you trusted.

Self-signed Certificate Usage Scenario

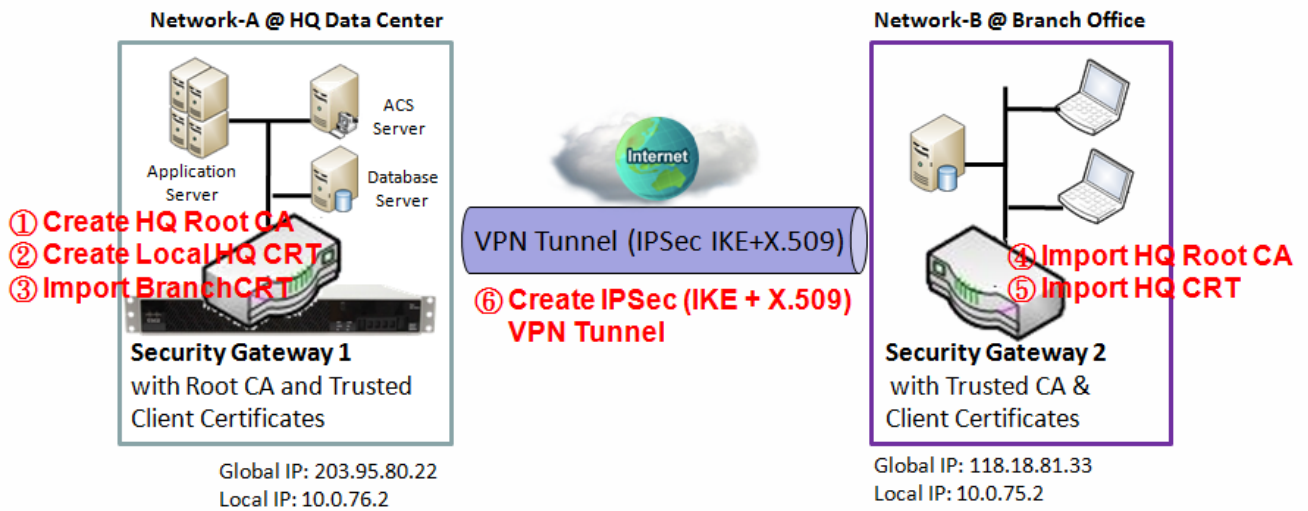

Scenario Application Timing (same as the one described in "My Certificate" section)

- When the enterprise router owns the root CA and VPN tunneling function, it can generate its own local certificates by being signed by itself. Also imports the trusted certificates for other CAs and Clients.
- These certificates can be used for two remote peers to make sure their identity during establishing a VPN tunnel.

Scenario Description (same as the one described in "My Certificate" section)

- Gateway 1 generates the root CA and a local certificate (HQCRT) signed by itself. Import a trusted certificate (BranchCRT) –a BranchCSR certificate of Gateway 2 signed by root CA of Gateway 1.
- Gateway 2 creates a CSR (BranchCSR) to let the root CA of the Gateway 1 sign it to be the BranchCRT certificate. Import the certificate into the Gateway 2 as a local certificate. In addition, also imports the certificates of the root CA of Gateway 1 into the Gateway 2 as the trusted ones. (Please also refer to "My Certificate" and "Issue Certificate" sections).
- Establish an IPsec VPN tunnel with IKE and X.509 protocols by starting from either peer, so that all client hosts in these both subnets can communicate with each other.

Parameter Setup Example (same as the one described in "My Certificate" section)

For Network-A at HQ

- Following tables list the parameter configuration as an example for the "Trusted Certificate" function used in the user authentication of IPsec VPN tunnel establishing, as shown in above diagram.
- The configuration example must be combined with the ones in "My Certificate" and "Issue Certificate" sections to complete the setup for the whole user scenario.

|                           |   |
|---------------------------|---|
| <b>Configuration Path</b> | [Trusted Certificate]-[Trusted Client Certificate List]               |
| <b>Command Button</b>     | Import  |
| <b>Configuration Path</b> | [Trusted Certificate]-[Trusted Client Certificate Import from a File] |
| <b>File</b>               | BranchCRT.crt   |

For Network-B at Branch Office

- Following tables list the parameter configuration as an example for the "Trusted Certificate" function used in the user authentication of IPsec VPN tunnel establishing, as shown in above diagram.
- The configuration example must be combined with the ones in "My Certificate" and "Issued Certificate" sections to complete the setup for the whole user scenario.

|                           |   |
|---------------------------|---|
| <b>Configuration Path</b> | [Trusted Certificate]-[Trusted CA Certificate List] |
| <b>Command Button</b>     | <i>Import</i>                                       |

|                           |   |
|---------------------------|---|
| <b>Configuration Path</b> | [Trusted Certificate]-[Trusted CA Certificate Import from a File] |
| <b>File</b>               | <i>HQRootCA.crt</i>   |

|                           |   |
|---------------------------|---|
| <b>Configuration Path</b> | [Trusted Certificate]-[Trusted Client Certificate List] |
| <b>Command Button</b>     | <i>Import</i>   |

|                           |   |
|---------------------------|---|
| <b>Configuration Path</b> | [Trusted Certificate]-[Trusted Client Certificate Import from a File] |
| <b>File</b>               | <i>HQCRT.crt</i>  |

**Scenario Operation Procedure** (same as the one described in "My Certificate" section)

- In above diagram, the "Gateway 1" is the gateway of Network-A in headquarters and the subnet of its Intranet is 10.0.76.0/24. It has the IP address of 10.0.76.2 for LAN interface and 203.95.80.22 for WAN-1 interface. The "Gateway 2" is the gateway of Network-B in branch office and the subnet of its Intranet is 10.0.75.0/24. It has the IP address of 10.0.75.2 for LAN interface and 118.18.81.33 for WAN-1 interface. They both serve as the NAT security gateways.
- In Gateway 2 import the certificates of the root CA and HQCRT that were generated and signed by Gateway 1 into the "Trusted CA Certificate List" and "Trusted Client Certificate List" of Gateway 2.
- Import the obtained BranchCRT certificate (the derived BranchCSR certificate after Gateway 1's root CA signature) into the "Trusted Client Certificate List" of the Gateway 1 and the "Local Certificate List" of the Gateway 2. For more details, refer to the Network-B operation procedure in "My Certificate" section of this manual.
- Gateway 2 can establish an IPsec VPN tunnel with "Site to Site" scenario and IKE and X.509 protocols to Gateway 1.
- Finally, the client hosts in two subnets of 10.0.75.0/24 and 10.0.76.0/24 can communicate with each other.



### Trusted Certificate Setting

Go to **Object Definition > Certificate > Trusted Certificate** tab.

The Trusted Certificate setting allows user to import trusted certificates and keys.

### Import Trusted CA Certificate

| <input type="checkbox"/> Trusted CA Certificate List <input type="button" value="Import"/> <input type="button" value="Delete"/> <input type="button" value="Get CA"/> |      |         |        |          |         |
|--|------|---------|--------|----------|---------|
| ID   | Name | Subject | Issuer | Vaild To | Actions |

When **Import** button is applied, a **Trusted CA import** screen will appear. You can import a Trusted CA certificate from an existed certificate file, or directly paste a PEM encoded string as the certificate.

Trusted CA Certificate Import from a File

No file chosen

---

Trusted CA Certificate Import from a PEM

#### Trusted CA Certificate List

| Item                      | Value setting  | Description  |
|---------------------------|--|--|
| <b>Import from a File</b> | A Must filled setting  | Select a CA certificate file from user's computer, and click the <b>Apply</b> button to import the specified CA certificate file to the router.  |
| <b>Import from a PEM</b>  | 1. String format can be any text<br>2. A Must filled setting | This is an alternative approach to import a CA certificate. You can directly fill in (Copy and Paste) the PEM encoded CA certificate string, and click the <b>Apply</b> button to import the specified CA certificate to the router. |
| <b>Apply</b>              | N/A  | Click the <b>Apply</b> button to import the certificate.   |
| <b>Cancel</b>             | N/A  | Click the <b>Cancel</b> button to discard the import operation and the screen will return to the Trusted Certificates page.  |

### Import Trusted Client Certificate

| Trusted Client Certificate List <input type="button" value="Import"/> <input type="button" value="Delete"/> |      |         |        |          |         |
|---|------|---------|--------|----------|---------|
| ID  | Name | Subject | Issuer | Vaild To | Actions |

When **Import** button is applied, a **Trusted Client Certificate Import** screen will appear. You can import a Trusted Client Certificate from an existed certificate file, or directly paste a PEM encoded string as the certificate.

Trusted Client Certificate Import from a File

No file chosen

Trusted Client Certificate Import from a PEM

| Trusted Client Certificate List |  |   |
|---------------------------------|--|---|
| Item                            | Value setting  | Description   |
| <b>Import from a File</b>       | A Must filled setting  | Select a certificate file from user's computer, and click the <b>Apply</b> button to import the specified certificate file to the router.   |
| <b>Import from a PEM</b>        | 1. String format can be any text<br>2. A Must filled setting | This is an alternative approach to import a certificate. You can directly fill in (Copy and Paste) the PEM encoded certificate string, and click the <b>Apply</b> button to import the specified certificate to the router. |
| <b>Apply</b>                    | N/A  | Click the <b>Apply</b> button to import certificate.  |
| <b>Cancel</b>                   | N/A  | Click the <b>Cancel</b> button to discard the import operation and the screen will return to the Trusted Certificates page.   |

### Import Trusted Client Key

Trusted Client Key List

| ID | Name | Actions |
|----|------|---------|
|----|------|---------|

When **Import** button is applied, a **Trusted Client Key Import** screen will appear. You can import a Trusted Client Key from an existed file, or directly paste a PEM encoded string as the key.

Trusted Client Key Import from a File

No file chosen

---

Trusted Client Key Import from a PEM

| Trusted Client Key List |  |   |
|-------------------------|--|---|
| Item                    | Value setting  | Description   |
| Import from a File      | A Must filled setting  | Select a certificate key file from user's computer, and click the <b>Apply</b> button to import the specified key file to the router.   |
| Import from a PEM       | 1. String format can be any text<br>2. A Must filled setting | This is an alternative approach to import a certificate key. You can directly fill in (Copy and Paste) the PEM encoded certificate key string, and click the <b>Apply</b> button to import the specified certificate key to the router. |
| Apply                   | N/A  | Click the <b>Apply</b> button to import the certificate key.  |
| Cancel                  | N/A  | Click the <b>Cancel</b> button to discard the import operation and the screen will return to the Trusted Certificates page.   |

## 4. Security

### 4.1 VPN

A virtual private network (VPN) extends a private network across a public network, such as the Internet. It enables a computer to send and receive data across shared or public networks as if it were directly connected to the private network, while benefitting from the functionality, security and management policies of the private network. This is done by establishing a virtual point-to-point connection through the use of dedicated connections, encryption, or a combination of the two. The tunnel technology supports data confidentiality, data origin authentication and data integrity of network information by utilizing encapsulation protocols, encryption algorithms, and hashing algorithms.

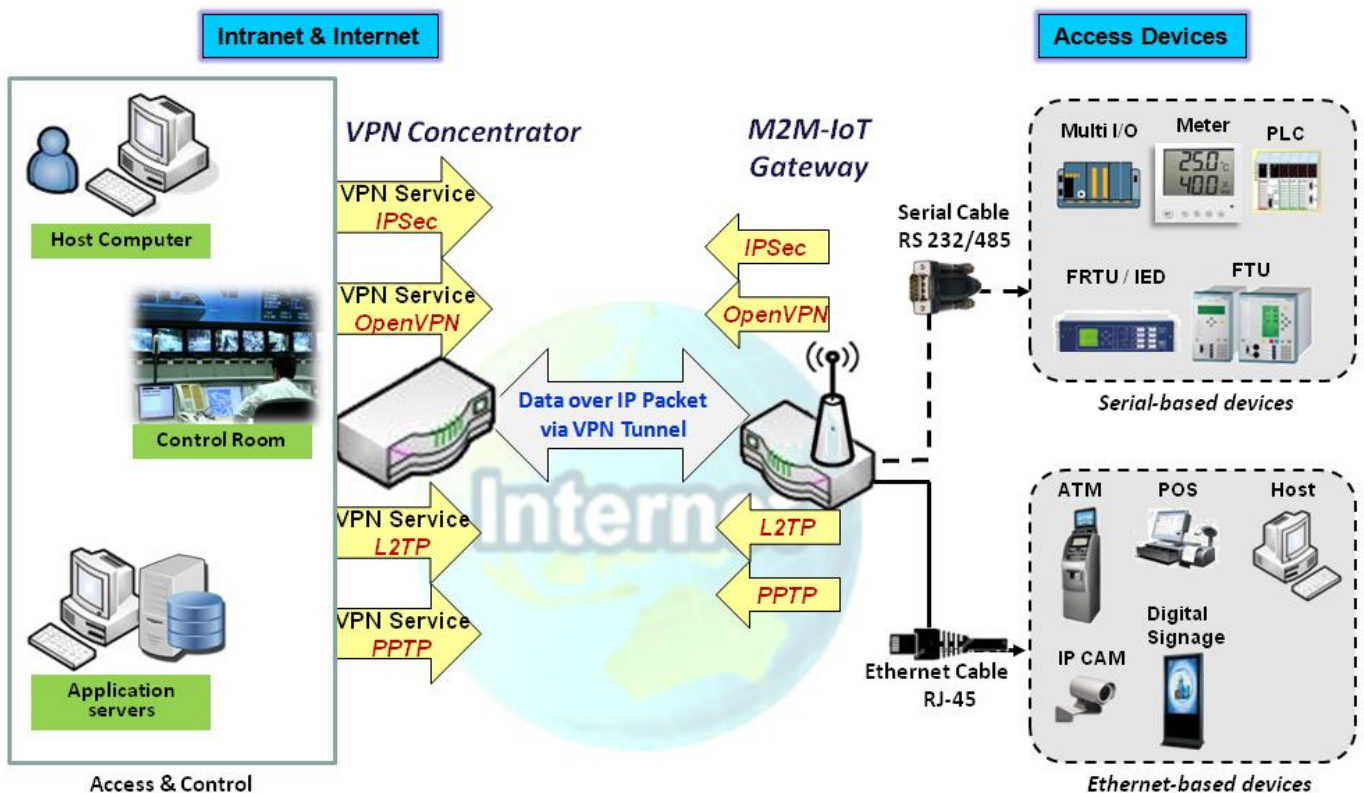

The product series supports different tunneling technologies to establish secure tunnels between multiple sites for data transferring, such as IPsec, OpenVPN, L2TP (over IPsec), PPTP and GRE. Besides, some advanced functions, like Full Tunnel, Tunnel Failover, NetBIOS over IPsec, NAT Traversal are also supported.

### 4.1.1 IPsec

| Configuration [ Help ]          |  |
|---------------------------------|--|
| Item                            | Setting                                    |
| ▶ IPsec                         | <input type="checkbox"/> Enable            |
| ▶ NetBIOS over IPsec            | <input type="checkbox"/> Enable            |
| ▶ NAT Traversal                 | <input checked="" type="checkbox"/> Enable |
| ▶ Max. Concurrent IPsec Tunnels | 3  |

| IPsec Tunnel List [ Add ] [ Delete ] [ Refresh ] |             |           |                 |                |               |        |        |         |
|--|-------------|-----------|-----------------|----------------|---------------|--------|--------|---------|
| ID   | Tunnel Name | Interface | Tunnel Scenario | Remote Gateway | Remote Subnet | Status | Enable | Actions |
|  |             |           |                 |                |               |        |        |         |

Internet Protocol Security (IPsec) is a protocol suite for securing Internet Protocol (IP) communications by authenticating and encrypting each IP packet of a communication session. IPsec includes protocols for establishing mutual authentication between agents at the beginning of the session and negotiation of cryptographic keys to be used during the session.

An IPsec VPN tunnel is established between IPsec client and server. Sometimes, we call the IPsec VPN client as the initiator and the IPsec VPN server as the responder. This router can be configured as different roles and establish number of tunnels with various remote devices. Before going to setup the VPN connections, you may need to decide the scenario type for the tunneling.

### IPsec Tunnel Scenarios

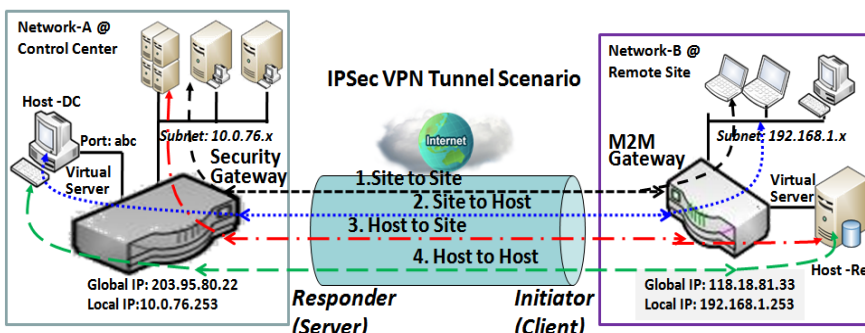

To build IPsec tunnel, you need to fill in remote gateway global IP, and optional subnet if the hosts behind IPsec peer can access to remote site or hosts. Under such configuration, there are four scenarios:

**Site to Site:** You need to setup remote gateway IP and subnet of both gateways. After the IPsec tunnel established, hosts behind both gateways can communication each other through the tunnel.

**Site to Host:** Site to Host is suitable for tunneling between clients in a subnet and an application server (host). As in the diagram, the clients behind the M2M gateway can access to the host "Host-DC" located in the control center through Site to Host VPN tunnel.

**Host to Site:** On the contrast, for a single host (or mobile user to) to access the resources located in an intranet, the Host to Site scenario can be applied.

**Host to Host:** Host to Host is a special configuration for building a VPN tunnel between two single hosts.

**Site to Site with "Full Tunnel" enabled**

In "Site to Site" scenario, client hosts in remote site can access the enterprise resources in the Intranet of HQ gateway via an established IPSec tunnel, as described above. However, Internet access originates from remote site still go through its regular WAN connection. If you want all packets from remote site to be routed via this IPSec tunnel, including HQ server access and Internet access, you can just enable the "Full Tunnel" setting. As a result, every time users surfs web or searching data on Internet, checking personal emails, or HQ server access, all traffics will go through the secure IPSec tunnel and route by the Security Gateway in control center.

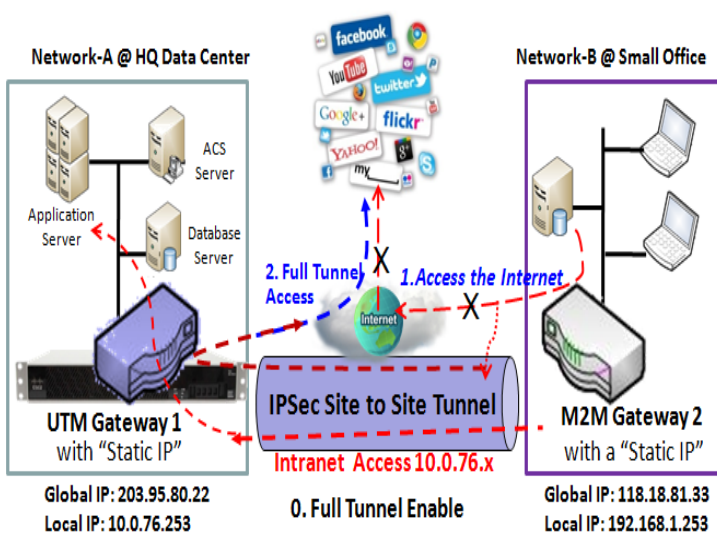

**Site to Site with "Hub and Spoke" mechanism**

For a control center to manage the secure Intranet among all its remote sites, there is a simple configuration, called **Hub and Spoke**, for the whole VPN network. A Hub and Spoke VPN Network is set up in organizations with centralized control center over all its remote sites, like shops or offices. The control center acts as the Hub role and the remote shops or Offices act as Spokes. All VPN tunnels from a remote sites terminate at this Hub, which acts as a concentrator. Site-to-site connections between spokes do not exist. Traffic originating from one spoke and destined for another spoke has to go via the Hub. Under such configuration, you don't need to maintain VPN tunnels between each two remote clients.

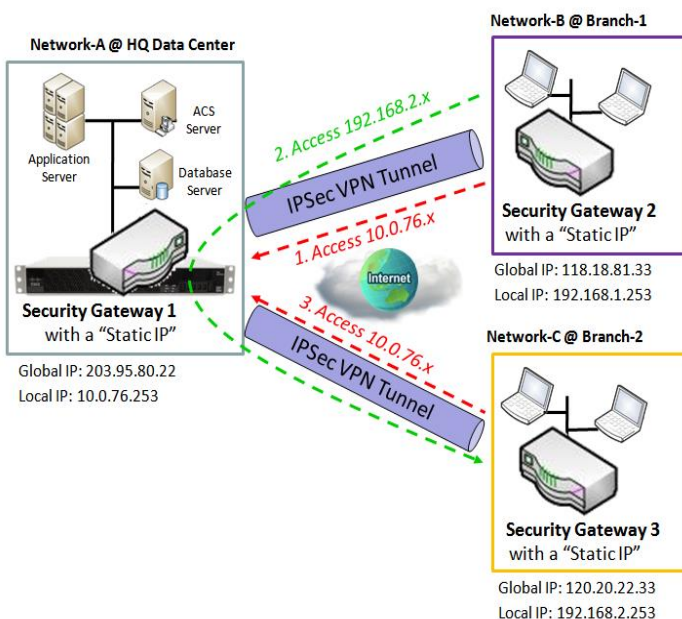

## IPSec Setting

Go to **Security > VPN > IPSec** tab.

The IPSec Setting allows user to create and configure IPSec tunnels.

### Enable IPSec

| Configuration <span style="float: right;">[ Help ]</span> |  |
|---|--|
| Item  | Setting                                    |
| ▶ IPSec   | <input type="checkbox"/> Enable            |
| ▶ NetBIOS over IPSec                                      | <input type="checkbox"/> Enable            |
| ▶ NAT Traversal   | <input checked="" type="checkbox"/> Enable |
| ▶ Max. Concurrent IPSec Tunnels                           | 3  |

| Configuration Window          |                                   |  |
|-------------------------------|-----------------------------------|--|
| Item                          | Value setting                     | Description  |
| IPSec                         | Unchecked by default              | Click the <b>Enable</b> box to enable IPSec function.  |
| NetBIOS over IPSec            | Unchecked by default              | Click the <b>Enable</b> box to enable NetBIOS over IPSec function.   |
| NAT Traversal                 | Checked by default                | Click the <b>Enable</b> box to enable NAT Traversal function.  |
| Max. Concurrent IPSec Tunnels | Depends on Product specification. | The specified value will limit the maximum number of simultaneous IPSec tunnel connection. The default value can be different for the purchased model. |
| Save                          | N/A                               | Click <b>Save</b> to save the settings   |
| Undo                          | N/A                               | Click <b>Undo</b> to cancel the settings   |

### Create/Edit IPSec tunnel

Ensure that the IPSec enable box is checked to enable before further configuring the IPSec tunnel settings.

| IPSec Tunnel List <span>Add</span> <span>Delete</span> <span>Refresh</span> |             |           |                 |                |               |        |        |         |
|---|-------------|-----------|-----------------|----------------|---------------|--------|--------|---------|
| ID  | Tunnel Name | Interface | Tunnel Scenario | Remote Gateway | Remote Subnet | Status | Enable | Actions |

When **Add/Edit** button is applied, a series of configuration screens will appear. They are Tunnel Configuration, Local & Remote Configuration, Authentication, IKE Phase, IKE Proposal Definition, IPSec Phase, and IPSec Proposal Definition. You have to configure the tunnel details for both local and remote VPN devices.

| Tunnel Configuration     |                                 |
|--------------------------|---------------------------------|
| Item                     | Setting                         |
| ▶ Tunnel                 | <input type="checkbox"/> Enable |
| ▶ Tunnel Name            | IPSec #1                        |
| ▶ Interface              | WAN1 ▼                          |
| ▶ Tunnel Scenario        | Site to Site ▼                  |
| ▶ Tunnel TCP MSS         | Auto ▼ 0 (64~1500 Bytes)        |
| ▶ Hub and Spoke          | None ▼                          |
| ▶ Operation Mode         | Always on ▼                     |
| ▶ Encapsulation Protocol | ESP ▼                           |

| Tunnel Configuration Window |   |  |
|-----------------------------|---|--|
| Item                        | Value setting   | Description  |
| <b>Tunnel</b>               | Unchecked by default  | Check the <b>Enable</b> box to activate the IPSec tunnel   |
| <b>Tunnel Name</b>          | 1. A Must fill setting<br>2. String format can be any text              | Enter a tunnel name. Enter a name that is easy for you to identify.<br><b>Value Range: 1 ~ 19 characters.</b>  |
| <b>Interface</b>            | 1. A Must fill setting<br>2. <b>WAN 1</b> is selected by default        | Select the interface on which IPSec tunnel is to be established. It can be the available WAN and LAN interfaces.   |
| <b>Tunnel Scenario</b>      | 1. A Must fill setting<br>2. <b>Site to site</b> is selected by default | Select an IPSec tunneling scenario from the dropdown box for your application. Select <b>Site-to-Site</b> , <b>Site-to-Host</b> , <b>Host-to-Site</b> , or <b>Host-to-Host</b> . If LAN interface is selected, only <b>Host-to-Host</b> scenario is available.<br><br>With <b>Site-to-Site</b> or <b>Site-to-Host</b> or <b>Host-to-Site</b> , IPSec operates in tunnel mode. The difference among them is the number of subnets. With <b>Host-to-Host</b> , IPSec operates in transport mode. |
| <b>Tunnel TCP MSS</b>       | 1. An optional setting<br>2. <b>Auto</b> is set by default              | Select from the dropdown box to define the size of Tunnel TCP MSS. Select <b>Auto</b> , and all devices will adjust this parameter automatically. Select <b>Manual</b> , and specify an expected value for Tunnel TCP MSS.<br><b>Value Range: 64 ~ 1500 bytes.</b>   |
| <b>Hub and Spoke</b>        | 1. An optional setting<br>2. <b>None</b> is set by default              | Select from the dropdown box to setup your router for Hub-and-Spoke IPSec VPN Deployments.<br>Select <b>None</b> if your deployments will not support Hub or Spoke encryption.<br>Select <b>Hub</b> for a Hub role in the IPSec design.<br>Select <b>Spoke</b> for a Spoke role in the IPSec design.<br>Note: Hub and Spoke are available only for Site-to-Site VPN tunneling specified in Tunnel Scenario.  |



|                               |  |  |
|-------------------------------|--|--|
| <b>Operation Mode</b>         | 1. A Must fill setting<br>2. <b>Always on</b> is selected by default | Define operation mode for the IPSec Tunnel. It can be <b>Always On</b> , or <b>Failover</b> . If this tunnel is set as a failover tunnel, you need to further select a primary tunnel from which to failover to.<br>Note: <b>Failover</b> mode is not available for the gateway with single WAN. |
| <b>Encapsulation Protocol</b> | 1. A Must fill setting<br>2. <b>ESP</b> is selected by default       | Select the Encapsulation Protocol from the dropdown box for this IPSec tunnel. Available encapsulations are <b>ESP</b> and <b>AH</b> .   |

Local & Remote Configuration

| Item  | Setting   |  |   |                                       |
|---|---|--|---|---------------------------------------|
| ▶ Local Subnet List                           | <b>ID</b>   | <b>Subnet IP Address</b>                   | <b>Subnet Mask</b>                              | <b>Actions</b>                        |
|   | 1   | <input type="text" value="192.168.123.0"/> | <input type="text" value="255.255.255.0(/24)"/> | <input type="button" value="Delete"/> |
|   | <input type="button" value="Add"/>                      |  |   |                                       |
|   | ▶ Redirect Traffic <input type="checkbox"/> Enable      |  |   |                                       |
| ▶ Full Tunnel <input type="checkbox"/> Enable |   |  |   |                                       |
| ▶ Remote Subnet List                          | <b>ID</b>   | <b>Subnet IP Address</b>                   | <b>Subnet Mask</b>                              | <b>Actions</b>                        |
|   | 1   | <input type="text"/>                       | <input type="text" value="255.255.255.0(/24)"/> | <input type="button" value="Delete"/> |
|   | <input type="button" value="Add"/>                      |  |   |                                       |
|   | ▶ Remote Gateway <input type="text"/> (IP Address/FQDN) |  |   |                                       |

| Local & Remote Configuration Window |                      |   |
|-------------------------------------|----------------------|---|
| Item                                | Value setting        | Description   |
| <b>Local Subnet List</b>            | A Must fill setting  | Specify the Local Subnet IP address and Subnet Mask.<br>Click the Add or Delete button to add or delete a Local Subnet.<br><br>Note_1: When Host-to-Site or Host-to-Host option in Tunnel Scenario is selected, Local Subnet will not be available.<br>Note_2: When Hub and Spoke option in Hub and Spoke is selected, there will be only one subnet available.   |
| <b>Redirect Traffic</b>             | Unchecked by default | Click <b>Enable</b> box to activate the Redirect Traffic function.<br><br>Note: Redirect Traffic is available only for Host-to-Site specified in Tunnel Scenario. By default, it is disabled, so it can prevent the un-expected and dangerous access to the peer subnet. If you enable such function, all the network devices behind the VPN host (actually, it is an NAT router) can access to the peer subnet with the host IP. |

|                           |  |  |
|---------------------------|--|--|
| <b>Full Tunnel</b>        | Unchecked by default   | Click <b>Enable</b> box to enable Full Tunnel.<br>Note: Full tunnel is available only for Site-to-Site specified in Tunnel Scenario. |
| <b>Remote Subnet List</b> | A Must fill setting  | Specify the Remote Subnet IP address and Subnet Mask.<br>Click the Add or Delete button to add or delete Remote Subnet setting.      |
| <b>Remote Gateway</b>     | 1. A Must fill setting.<br>2. Format can be a ipv4 address or FQDN | Specify the Remote Gateway.  |

Authentication

| Item             | Setting  |
|------------------|--|
| ▶ Key Management | <div style="display: flex; align-items: center;"> <div style="border: 1px solid #ccc; padding: 2px; margin-right: 5px;">                     IKE+Pre-shared Key ▼<br/> <small style="color: red;">(Min. 8 characters)</small> </div> <input style="width: 80%; height: 20px;" type="text"/> </div> |
| ▶ Local ID       | Type: <div style="border: 1px solid #ccc; padding: 2px; display: inline-block;">User Name ▼</div> ID: <input style="width: 60px;" type="text"/> (Optional)   |
| ▶ Remote ID      | Type: <div style="border: 1px solid #ccc; padding: 2px; display: inline-block;">User Name ▼</div> ID: <input style="width: 60px;" type="text"/>  |

| Authentication Configuration Window |   |  |
|-------------------------------------|---|--|
| Item                                | Value setting   | Description  |
| <b>Key Management</b>               | 1. A Must fill setting<br>2. Pre-shared Key 8 to 32 characters. | Select Key Management from the dropdown box for this IPSec tunnel.<br><b>IKE + Pre-shared Key:</b> user needs to set a key (8 ~ 32 characters).<br><b>IKE+X.509:</b> user needs Certificate to authenticate. IKE+X.509 will be available only when Certificate has been configured properly. Refer to Certificate section of this manual and also <b>Object Definition &gt; Certificate</b> in web-based utility.<br><b>Manually:</b> user needs to enter key ID to authenticate. Manual key configuration will be explained in the following Manual Key Management section. |
| <b>Local ID</b>                     | An optional setting   | Specify the Local ID for this IPSec tunnel to authenticate.<br>Select <b>User Name</b> for Local ID and enter the username. The username may include but can't be all numbers.<br>Select <b>FQDN</b> for Local ID and enter the FQDN.<br>Select <b>User@FQDN</b> for Local ID and enter the User@FQDN.<br>Select <b>Key ID</b> for Local ID and enter the Key ID (English alphabet or number).   |
| <b>Remote ID</b>                    | An optional setting   | Specify the Remote ID for this IPSec tunnel to authenticate.<br>Select <b>User Name</b> for Remote ID and enter the username. The username may include but can't be all numbers.<br>Select <b>FQDN</b> for Local ID and enter the FQDN.<br>Select <b>User@FQDN</b> for Remote ID and enter the User@FQDN.<br>Select <b>Key ID</b> for Remote ID and enter the Key ID (English alphabet or number).   |

| IKE Phase                   |  |
|-----------------------------|--|
| Item                        | Setting  |
| ▶ IKE Version               | v1 ▾   |
| ▶ Negotiation Mode          | Main Mode ▾  |
| ▶ X-Auth                    | None ▾ X-Auth Account (Optional)<br>User Name : <input type="text"/> Password : <input type="text"/>   |
| ▶ Dead Peer Detection (DPD) | <input checked="" type="checkbox"/> Enable<br>Timeout : <input type="text" value="180"/> (seconds) Delay : <input type="text" value="30"/> (seconds) |
| ▶ Phase1 Key Life Time      | <input type="text" value="3600"/> (seconds) (Max. 86400)   |

### IKE Phase Window

| Item                             | Value setting  | Description   |
|----------------------------------|--|---|
| <b>IKE Version</b>               | 1. A must fill setting<br>2. v1 is selected by default         | Specify the IKE version for this IPSec tunnel. Select v1 or v2<br>Note: IKE versions will not be available when AH option in Encapsulation Protocol is selected.  |
| <b>Negotiation Mode</b>          | Main Mode is set by default                                    | Specify the Negotiation Mode for this IPSec tunnel. Select Main Mode or Aggressive Mode.  |
| <b>X-Auth</b>                    | None is selected by default                                    | Specify the X-Auth role for this IPSec tunnel. Select Server, Client, or None.<br>Selected None no X-Auth authentication is required.<br>Selected Server this gateway will be an X-Auth server. Click on the X-Auth Account button to create remote X-Auth client account.<br>Selected Client this gateway will be an X-Auth client. Enter User name and Password to be authenticated by the X-Auth server gateway. |
| <b>Dead Peer Detection (DPD)</b> | 1. Checked by default<br>2. Default Timeout 180s and Delay 30s | Click <b>Enable</b> box to enable <b>DPD</b> function. Specify the <b>Timeout</b> and <b>Delay</b> time in seconds.<br><b>Value Range: 0 ~ 999 seconds for Timeout and Delay.</b>   |
| <b>Phase1 Key Life Time</b>      | 1. A Must fill setting<br>2. Default 3600s<br>3. Max. 86400s   | Specify the Phase1 Key Life Time.<br><b>Value Range: 30 ~ 86400.</b>  |

## ☐ IKE Proposal Definition

| ID | Encryption | Authentication | DH Group  | Definition                                 |
|----|------------|----------------|-----------|--|
| 1  | AES-auto ▼ | SHA1 ▼         | Group 2 ▼ | <input checked="" type="checkbox"/> Enable |
| 2  | AES-auto ▼ | MD5 ▼          | Group 2 ▼ | <input checked="" type="checkbox"/> Enable |
| 3  | DES ▼      | SHA1 ▼         | Group 2 ▼ | <input checked="" type="checkbox"/> Enable |
| 4  | 3DES ▼     | SHA1 ▼         | Group 2 ▼ | <input checked="" type="checkbox"/> Enable |

## IKE Proposal Definition Window

| Item                    | Value setting       | Description   |
|-------------------------|---------------------|---|
| IKE Proposal Definition | A Must fill setting | <p>Specify the Phase 1 Encryption method. It can be DES / 3DES / AES-auto / AES-128 / AES-192 / AES-256.</p> <p>Specify the Authentication method. It can be None / MD5 / SHA1 / SHA2-256.</p> <p>Specify the DH Group. It can be None / Group1 / Group2 / Group5 / Group14 / Group15 / Group16 / Group17 / Group18.</p> <p>Check Enable box to enable this setting</p> |

## ☐ IPsec Phase

| Item                   | Setting                      |
|------------------------|------------------------------|
| ▶ Phase2 Key Life Time | 28800 (seconds) (Max. 86400) |

## IPsec Phase Window

| Item                 | Value setting   | Description   |
|----------------------|---|---|
| Phase2 Key Life Time | <ol style="list-style-type: none"> <li>1. A Must fill setting</li> <li>2. 28800s is set by default</li> <li>3. Max. 86400s</li> </ol> | <p>Specify the Phase2 Key Life Time in second.</p> <p><b>Value Range: 30 ~ 86400.</b></p> |

| IPSec Proposal Definition |            |                |           |  |
|---------------------------|------------|----------------|-----------|--|
| ID                        | Encryption | Authentication | PFS Group | Definition                                 |
| 1                         | AES-auto ▼ | SHA1 ▼         | Group 2 ▼ | <input checked="" type="checkbox"/> Enable |
| 2                         | AES-auto ▼ | MD5 ▼          |           | <input checked="" type="checkbox"/> Enable |
| 3                         | DES ▼      | SHA1 ▼         |           | <input checked="" type="checkbox"/> Enable |
| 4                         | 3DES ▼     | SHA1 ▼         |           | <input checked="" type="checkbox"/> Enable |

| IPSec Proposal Definition Window |                     |   |
|----------------------------------|---------------------|---|
| Item                             | Value setting       | Description   |
| IPSec Proposal Definition        | A Must fill setting | <p>Specify the Encryption method. It can be None / DES / 3DES / AES-auto / AES-128 / AES-192 / AES-256.<br/>Note: None is available only when Encapsulation Protocol is set as <b>AH</b>; it is not available for <b>ESP</b> Encapsulation.</p> <p>Specify the Authentication method. It can be None / MD5 / SHA1 / SHA2-256.<br/>Note: None and SHA2-256 are available only when Encapsulation Protocol is set as <b>ESP</b>; they are not available for <b>AH</b> Encapsulation.</p> <p>Specify the PFS Group. It can be None / Group1 / Group2 / Group5 / Group14 / Group15 / Group16 / Group17 / Group18.</p> <p>Click <b>Enable</b> to enable this setting</p> |
| Save                             | N/A                 | Click <b>Save</b> to save the settings  |
| Undo                             | N/A                 | Click <b>Undo</b> to cancel the settings  |
| Back                             | N/A                 | Click <b>Back</b> to return to the previous page.   |

### Manual Key Management

When the Manually option is selected for Key Management as described in Authentication Configuration Window, a series of configuration windows for Manual IPSec Tunnel configuration will appear. The configuration windows are the Local & Remote Configuration, the Authentication, and the Manual Proposal.

| Authentication   |  |
|------------------|--|
| Item             | Setting  |
| ▶ Key Management | Manually ▼   |
| ▶ Local ID       | Type: KEY ID ▼ ID: <input type="text"/> (Optional) |
| ▶ Remote ID      | Type: KEY ID ▼ ID: <input type="text"/>            |

| Authentication Window |                     |   |
|-----------------------|---------------------|---|
| Item                  | Value setting       | Description   |
| Key Management        | A Must fill setting | Select Key Management from the dropdown box for this IPSec tunnel. In this section <b>Manually</b> is the option selected.                                  |
| Local ID              | An optional setting | Specify the <b>Local ID</b> for this IPSec tunnel to authenticate. Select the <b>Key ID</b> for Local ID and enter the Key ID (English alphabet or number). |
| Remote ID             | An optional setting | Specify the <b>Remote ID</b> for this IPSec tunnel to authenticate. Select <b>Key ID</b> for Remote ID and enter the Key ID (English alphabet or number).   |

▣ Local & Remote Configuration

| Item             | Setting                                    |
|------------------|--|
| ▶ Local Subnet   | <input type="text"/>                       |
| ▶ Local Netmask  | <input type="text" value="255.255.255.0"/> |
| ▶ Remote Subnet  | <input type="text"/>                       |
| ▶ Remote Netmask | <input type="text"/>                       |
| ▶ Remote Gateway | <input type="text"/> (IP Address/FQDN)     |

| Local & Remote Configuration Window |   |  |
|-------------------------------------|---|--|
| Item                                | Value setting   | Description  |
| Local Subnet                        | A Must fill setting   | Specify the Local Subnet IP address and Subnet Mask. |
| Local Netmask                       | A Must fill setting   | Specify the Local Subnet Mask.                       |
| Remote Subnet                       | A Must fill setting   | Specify the Remote Subnet IP address                 |
| Remote Netmask                      | A Must fill setting   | Specify the Remote Subnet Mask.                      |
| Remote Gateway                      | 1. A Must fill setting<br>2. An IPv4 address or FQDN format | Specify the Remote Gateway. The Remote Gateway       |

Under the Manually Key Management authentication configuration, only one subnet is supported for both Local and Remote IPSec peer.

| Manual Proposal  |                           |
|------------------|---------------------------|
| Item             | Setting                   |
| ▶ Outbound SPI   | 0x <input type="text"/>   |
| ▶ Inbound SPI    | 0x <input type="text"/>   |
| ▶ Encryption     | DES <input type="text"/>  |
| ▶ Authentication | None <input type="text"/> |

| Manual Proposal Window |   |  |
|------------------------|---|--|
| Item                   | Value setting                                   | Description  |
| <b>Outbound SPI</b>    | Hexadecimal format                              | Specify the Outbound SPI for this IPsec tunnel.<br><i>Value Range: 0 ~ FFFF.</i>   |
| <b>Inbound SPI</b>     | Hexadecimal format                              | Specify the Inbound SPI for this IPsec tunnel.<br><i>Value Range: 0 ~ FFFF.</i>  |
| <b>Encryption</b>      | 1. A Must fill setting<br>2. Hexadecimal format | Specify the Encryption Method and Encryption key.<br>Available encryption methods are DES/3DES/AES-128/AES-192/AES-256.<br>The key length for DES is 16, 3DES is 48, AES-128 is 32, AES-192 is 48, and AES-256 is 64.<br>Note: When <b>AH</b> option in Encapsulation is selected, encryption will not be available. |
| <b>Authentication</b>  | 1. A Must fill setting<br>2. Hexadecimal format | Specify the Authentication Method and Authentication key.<br>Available encryptions are None/MD5/SHA1/SHA2-256.<br>The key length for MD5 is 32, SHA1 is 40, and SHA2-256 is 64.<br>Note: When <b>AH</b> option in Encapsulation Protocol is selected, None option in Authentication will not be available.           |
| <b>Save</b>            | N/A   | Click <b>Save</b> to save the settings   |
| <b>Undo</b>            | N/A   | Click <b>Undo</b> to cancel the settings   |
| <b>Back</b>            | N/A   | Click <b>Back</b> to return to the previous page.  |

## 4.1.2 OpenVPN

OpenVPN is an application that implements virtual private network (VPN) techniques for creating secure point-to-point or site-to-site connections in routed or bridged configurations and remote access facilities. It uses a custom security protocol that utilizes SSL/TLS for key exchange. It is capable of traversing network address translators (NATs) and firewalls.

OpenVPN allows peers to authenticate each other using a Static Key (pre-shared key) or certificates. When used in a multi-client-server configuration, it allows the server to release an authentication certificate for every client, using signature and certificate authority. It uses the OpenSSL encryption library extensively, as well as the SSLv3/TLSv1 protocol, and contains many security and control features.

OpenVPN Tunneling is a Client and Server based tunneling technology. The OpenVPN Server must have a Static IP or a FQDN, and maintain a Client list. The OpenVPN Client may be a mobile user or mobile site with public IP or private IP, and requesting the OpenVPN tunnel connection. The product can only behave as an OpenVPN Client role for an OpenVPN tunnel connection.

There are two OpenVPN connection scenarios. They are the TAP and TUN scenarios. The product can create either a layer-3 based IP tunnel (TUN), or a layer-2 based Ethernet TAP that can carry any type of Ethernet traffic. In addition to configuring the device as a Server or Client, you have to specify which type of OpenVPN connection scenario is to be adopted.

### OpenVPN TUN Scenario

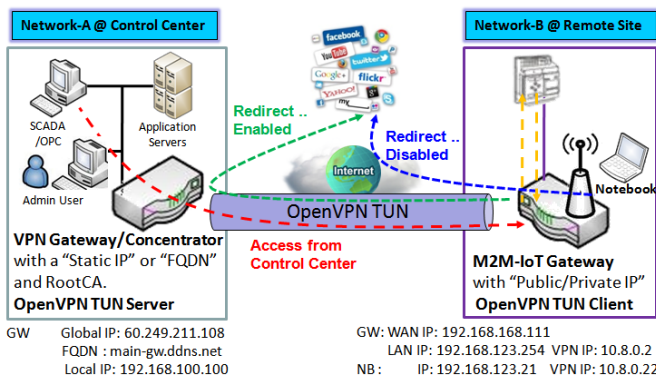

1. M2M-IoT Gateway (as OpenVPN TUN Client) connects to peer VPN Gateway/Concentrator (as OpenVPN TUN Server).
2. M2M-IoT Gateway will be assigned 10.8.0.2 IP Address after OpenVPN TUN Connection established. (10.8.0.x is a virtual subnet)
3. Local networked device will get a virtual IP 10.8.0.x if its traffic goes through the OpenVPN TUN connection (when NAT disabled & Redirect Internet Traffic enabled).
4. SCADA Server in Control Center can access remote attached device(s) with the assigned IP Address 10.8.0.2.

The term "TUN" mode is referred to routing mode and operates with layer 3 packets. In routing mode, the VPN client is given an IP address on a different subnet than the local LAN under the OpenVPN server. This virtual subnet is created for connecting to any remote VPN computers. In routing mode, the OpenVPN server creates a "TUN" interface with its own IP address pool which is different to the local LAN. Remote hosts that dial-in will get an IP address inside the virtual network and will have access only to the server where OpenVPN resides. If you want to offer remote access to a VPN server from client(s), and inhibit the access to remote LAN resources under VPN server, OpenVPN TUN mode is the simplest solution.

As shown in the diagram, the M2M-IoT Gateway is configured as an OpenVPN TUN Client, and connects to an OpenVPN UN Server. Once the OpenVPN TUN connection is established, the connected TUN client will be assigned a virtual IP (10.8.0.2) which is belong to a virtual subnet that is different to the local subnet in Control Center. With such connection, the local networked devices will get a virtual IP 10.8.0.x if its traffic goes through the OpenVPN TUN connection when Redirect Internet Traffic settings is enabled; Besides, the SCADA Server in Control Center can access remote attached serial device(s) with the virtual IP address (10.8.0.2).



## OpenVPN TAP Scenario

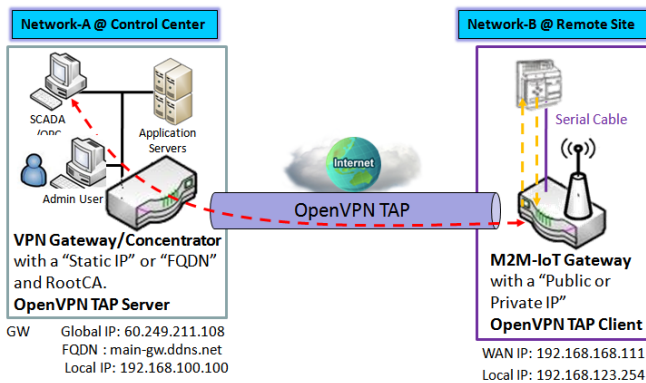

1. M2M-IoT Gateway (as OpenVPN TAP Client) connects to peer VPN Gateway/Concentrator (as OpenVPN TAP Server).
2. M2M-IoT Gateway will be assigned **192.168.100.210** IP Address after OpenVPN TAP Connection established. (same subnet as in Control Center)
3. SCADA Server in Control Center can access remote attached device(s) with the assigned IP Address 192.168.100.210.

The term "TAP" is referred to bridge mode and operates with layer 2 packets. In bridge mode, the VPN client is given an IP address on the same subnet as the LAN resided under the OpenVPN server. Under such configuration, the OpenVPN client can directly access to the resources in LAN. If you want to offer remote access to the entire remote LAN for VPN client(s), you have to setup OpenVPN in "TAP" bridge mode.

As shown in the diagram, the M2M-IoT Gateway is configured as an OpenVPN TAP Client, and connects to an OpenVPN TAP Server. Once the OpenVPN TAP connection is established, the connected TAP client will be assigned a virtual IP (192.168.100.210) which is the same subnet as that of local subnet in Control Center. With such connection, the SCADA Server in Control Center can access remote attached serial device(s) with the virtual IP address (192.168.100.210).

### Open VPN Setting

Go to **Security > VPN > OpenVPN** tab.

The OpenVPN setting allows user to create and configure OpenVPN tunnels.

### Enable OpenVPN

| Configuration |                                 |
|---------------|---------------------------------|
| Item          | Setting                         |
| ▶ OpenVPN     | <input type="checkbox"/> Enable |
| ▶ Client      | Client ▾                        |

| Configuration |                                       |  |
|---------------|---------------------------------------|--|
| Item          | Value setting                         | Description  |
| OpenVPN       | The box is unchecked by default       | Check the <b>Enable</b> box to activate the OpenVPN function.  |
| Client        | <b>Client</b> is selected by default. | Only <b>Client</b> is available, you can specify the client settings in another client configuration window. |

### As an OpenVPN Client

If **Client** is selected, an OpenVPN Client List screen will appear.

| OpenVPN Client List |             |           |          |      |                 |                |               |                           |     |                    |                   |                |        |         |
|---------------------|-------------|-----------|----------|------|-----------------|----------------|---------------|---------------------------|-----|--------------------|-------------------|----------------|--------|---------|
| ID                  | Client Name | Interface | Protocol | Port | Tunnel Scenario | Remote IP/FQDN | Remote Subnet | Redirect Internet Traffic | NAT | Authorization Mode | Encryption Cipher | Hash Algorithm | Enable | Actions |

When **Add** button is applied, OpenVPN Client Configuration screen will appear. **OpenVPN Client Configuration** window let you specify the required parameters for an OpenVPN VPN client, such as "OpenVPN Client Name", "Interface", "Protocol", "Tunnel Scenario", "Remote IP/FQDN", "Remote Subnet", "Authorization Mode", "Encryption Cipher", "Hash Algorithm" and tunnel activation.

| OpenVPN Client Configuration |  |
|------------------------------|--|
| Item                         | Setting  |
| ▶ OpenVPN Client Name        | OpenVPN Client #   |
| ▶ Interface                  | WAN 1 ▼  |
| ▶ Protocol                   | TCP ▼ Port: 443  |
| ▶ Tunnel Scenario            | TUN ▼  |
| ▶ Remote IP/FQDN             |  |
| ▶ Remote Subnet              | <input type="checkbox"/> Enable <input type="text"/> 255.255.255.0(/24) ▼  |
| ▶ Redirect Internet Traffic  | <input type="checkbox"/> Enable  |
| ▶ NAT                        | <input checked="" type="checkbox"/> Enable   |
| ▶ Authorization Mode         | TLS ▼<br>CA Cert.: ▼ Client Cert.: ▼ Client Key.: ▼ <span style="color: red;">Please set the Certificate.</span> |
| ▶ Encryption Cipher          | Blowfish ▼   |
| ▶ Hash Algorithm             | SHA-1 ▼  |
| ▶ LZO Compression            | Adaptive ▼   |
| ▶ Persist Key                | <input checked="" type="checkbox"/> Enable   |
| ▶ Persist Tun                | <input checked="" type="checkbox"/> Enable   |
| ▶ Advanced Configuration     | <input type="button" value="Edit"/>  |
| ▶ Tunnel                     | <input type="checkbox"/> Enable  |

| OpenVPN Client Configuration |   |  |
|------------------------------|---|--|
| Item                         | Value setting   | Description  |
| <b>OpenVPN Client Name</b>   | 1. A Must filled setting  | The <b>OpenVPN Client Name</b> will be used to identify the client in the tunnel list.<br><span style="color: red;"><b>Value Range:</b> 1 ~ 32 characters.</span>  |
| <b>Interface</b>             | 1. A Must filled setting<br>2. By default <b>WAN-1</b> is selected. | Define the physical interface to be used for this OpenVPN Client tunnel.   |
| <b>Protocol</b>              | 1. A Must filled setting<br>2. By default <b>TCP</b> is selected.   | Define the <b>Protocol</b> for the OpenVPN Client.<br><ul style="list-style-type: none"> <li>Select <b>TCP</b><br/>-&gt;The OpenVPN will use TCP protocol, and <b>Port</b> will be set as 443 automatically.</li> <li>Select <b>UDP</b><br/>-&gt; The OpenVPN will use UDP protocol, and <b>Port</b> will be set as 1194 automatically.</li> </ul> |
| <b>Port</b>                  | 1. A Must filled setting<br>2. By default <b>443</b> is set.        | Specify the <b>Port</b> for the OpenVPN Client to use.<br><span style="color: red;"><b>Value Range:</b> 1 ~ 65535.</span>  |

|                                   |   |   |
|-----------------------------------|---|---|
| <b>Tunnel Scenario</b>            | 1. A Must filled setting<br>2. By default <b>TUN</b> is selected. | Specify the type of <b>Tunnel Scenario</b> for the OpenVPN Client to use. It can be <b>TUN</b> for TUN tunnel scenario, or <b>TAP</b> for TAP tunnel scenario.  |
| <b>Remote IP/FQDN</b>             | A Must filled setting   | Specify the <b>Remote IP/FQDN</b> of the peer OpenVPN Server for this OpenVPN Client tunnel.<br>Fill in the IP address or FQDN.   |
| <b>Remote Subnet</b>              | 1. An Optional setting.<br>2. The box is unchecked by default.    | Check the <b>Enable</b> box to activate remote subnet function, and specify <b>Remote Subnet</b> of the peer OpenVPN Server for this OpenVPN Client tunnel.<br>Fill in the remote subnet address and remote subnet mask.  |
| <b>Redirect Internet Traffic</b>  | 1. An Optional setting.<br>2. The box is unchecked by default.    | Check the <b>Enable</b> box to activate the <b>Redirect Internet Traffic</b> function.  |
| <b>NAT</b>                        | 1. An Optional setting.<br>2. The box is unchecked by default.    | Check the <b>Enable</b> box to activate the <b>NAT</b> function.  |
| <b>Authorization Mode</b>         | 1. A Must filled setting<br>2. By default <b>TLS</b> is selected. | Specify the authorization mode for the OpenVPN Server. <ul style="list-style-type: none"> <li>• <b>TLS</b><br/>-&gt;The OpenVPN will use TLS authorization mode, and the following items <b>CA Cert.</b>, <b>Client Cert.</b> and <b>Client Key</b> will be displayed.<br/><b>CA Cert.</b> could be selected in Trusted CA Certificate List. Refer to <b>Object Definition &gt; Certificate &gt; Trusted Certificate</b>.<br/><b>Client Cert.</b> could be selected in Local Certificate List. Refer to <b>Object Definition &gt; Certificate &gt; My Certificate</b>.<br/><b>Client Key</b> could be selected in Trusted Client key List. Refer to <b>Object Definition &gt; Certificate &gt; Trusted Certificate</b>.</li> <li>• <b>Static Key</b><br/>-&gt;The OpenVPN will use static key authorization mode, and the following items <b>Local Endpoint IP Address</b>, <b>Remote Endpoint IP Address</b> and <b>Static Key</b> will be displayed.</li> </ul> |
| <b>Local Endpoint IP Address</b>  | A Must filled setting   | Specify the virtual <b>Local Endpoint IP Address</b> of this OpenVPN gateway.<br><b>Value Range:</b> The IP format is 10.8.0.x, the range of x is 1~254.<br><br>Note: Local Endpoint IP Address will be available only when Static Key is chosen in Authorization Mode.   |
| <b>Remote Endpoint IP Address</b> | A Must filled setting   | Specify the virtual <b>Remote Endpoint IP Address</b> of the peer OpenVPN gateway.<br><b>Value Range:</b> The IP format is 10.8.0.x, the range of x is 1~254.<br><br>Note: Remote Endpoint IP Address will be available only when Static Key is chosen in Authorization Mode.   |
| <b>Static Key</b>                 | A Must filled setting   | Specify the <b>Static Key</b> .<br>Note: Static Key will be available only when Static Key is chosen in Authorization Mode.   |
| <b>Encryption Cipher</b>          | By default <b>Blowfish</b> is selected.                           | Specify the <b>Encryption Cipher</b> .<br>It can be <b>Blowfish/AES-256/AES-192/AES-128/None</b> .  |

|                               |  |   |
|-------------------------------|--|---|
| <b>Hash Algorithm</b>         | By default <b>SHA-1</b> is selected.                         | Specify the <b>Hash Algorithm</b> .<br>It can be <b>SHA-1/MD5/MD4/SHA2-256/SHA2-512/None/Disable</b> .  |
| <b>LZO Compression</b>        | By default <b>Adaptive</b> is selected.                      | Specify the <b>LZO Compression</b> scheme.<br>It can be <b>Adaptive/YES/NO/Default</b> .  |
| <b>Persis Key</b>             | 1. An Optional setting.<br>2. The box is checked by default. | Check the <b>Enable</b> box to activate the <b>Persis Key</b> function.   |
| <b>Persis Tun</b>             | 1. An Optional setting.<br>2. The box is checked by default. | Check the <b>Enable</b> box to activate the <b>Persis Tun</b> function.   |
| <b>Advanced Configuration</b> | N/A  | Click the <b>Edit</b> button to specify the <b>Advanced Configuration</b> setting for the OpenVPN server.<br>If the button is clicked, <b>Advanced Configuration</b> will be displayed below. |
| <b>Tunnel</b>                 | The box is unchecked by default                              | Check the <b>Enable</b> box to activate this OpenVPN tunnel.  |
| <b>Save</b>                   | N/A  | Click <b>Save</b> to save the settings.   |
| <b>Undo</b>                   | N/A  | Click <b>Undo</b> to cancel the changes.  |
| <b>Back</b>                   | N/A  | Click <b>Back</b> to return to last page.   |

When **Advanced Configuration** is selected, an OpenVPN Client Advanced Configuration screen will appear.

| OpenVPN Advanced Client Configuration   |   |   |
|---|---|---|
| Item                                    | Value setting   | Description   |
| <b>TLS Cipher</b>                       | 1. A Must filled setting.<br>2. <b>TLS-RSA-WITH-AES128-SHA</b> is selected by default | Specify the <b>TLS Cipher</b> from the dropdown list.<br>It can be <b>None / TLS-RSA-WITH-RC4-MD5 / TLS-RSA-WITH-AES128-SHA / TLS-RSA-WITH-AES256-SHA / TLS-DHE-DSS-AES128-SHA / TLS-DHE-DSS-AES256-SHA.</b><br>Note: TLS Cipher will be available only when TLS is chosen in Authorization Mode. |
| <b>TLS Auth. Key</b>                    | 1. An Optional setting.<br>2. String format: any text                                 | Specify the <b>TLS Auth. Key</b> for connecting to an OpenVPN server, if the server required it.<br>Note: TLS Auth. Key will be available only when TLS is chosen in Authorization Mode.  |
| <b>User Name</b>                        | An Optional setting.  | Enter the <b>User account</b> for connecting to an OpenVPN server, if the server required it.<br>Note: User Name will be available only when TLS is chosen in Authorization Mode.   |
| <b>Password</b>                         | An Optional setting.  | Enter the <b>Password</b> for connecting to an OpenVPN server, if the server required it.<br>Note: User Name will be available only when TLS is chosen in Authorization Mode.   |
| <b>Bridge TAP to</b>                    | By default <b>VLAN 1</b> is selected  | Specify the setting of “ <b>Bridge TAP to</b> ” to bridge the TAP interface to a certain local network interface or VLAN.<br>Note: Bridge TAP to will be available only when TAP is chosen in Tunnel Scenario and NAT is unchecked.   |
| <b>Firewall Protection</b>              | The box is unchecked by default.  | Check the box to activate the <b>Firewall Protection</b> function.<br>Note: Firewall Protection will be available only when NAT is enabled.   |
| <b>Client IP Address</b>                | By default <b>Dynamic IP</b> is selected  | Specify the virtual IP Address for the OpenVPN Client.<br>It can be <b>Dynamic IP/Static IP.</b>  |
| <b>Tunnel MTU</b>                       | 1.A Must filled setting<br>2.The value is 1500 by default                             | Specify the value of <b>Tunnel MTU.</b><br><b>Value Range: 0 ~ 1500.</b>  |
| <b>Tunnel UDP Fragment</b>              | The value is 1500 by default  | Specify the value of <b>Tunnel UDP Fragment.</b><br><b>Value Range: 0 ~ 1500.</b><br>Note: Tunnel UDP Fragment will be available only when UDP is chosen in Protocol.   |
| <b>Tunnel UDP MSS-Fix</b>               | The box is unchecked by default.  | Check the <b>Enable</b> box to activate the <b>Tunnel UDP MSS-Fix</b> function.<br>Note: Tunnel UDP MSS-Fix will be available only when UDP is chosen in Protocol.  |
| <b>nsCerType Verification</b>           | The box is unchecked by default.  | Check the <b>Enable</b> box to activate the <b>nsCerType Verification</b> function.<br>Note: nsCerType Verification will be available only when TLS is chosen in Authorization Mode.  |
| <b>TLS Renegotiation Time (seconds)</b> | The value is 3600 by default  | Specify the time interval of <b>TLS Renegotiation Time.</b><br><b>Value Range: -1 ~ 86400.</b>  |
| <b>Connection Retry(seconds)</b>        | The value is -1 by default  | Specify the time interval of <b>Connection Retry.</b><br>The default -1 means that it is no need to execute connection retry.<br><b>Value Range: -1 ~ 86400, and -1 means no retry is required.</b>   |

|                                 |   |  |
|---------------------------------|---|--|
| <b>DNS</b>                      | By default <b>Automatically</b> is selected | Specify the setting of <b>DNS</b> . It can be <b>Automatically/Manually</b> .  |
| <b>Additional Configuration</b> | An Optional setting.                        | Enter optional configuration string here. Up to 256 characters is allowable.<br><b>Value Range: 0 ~ 256characters.</b> |
| <b>Save</b>                     | N/A   | Click <b>Save</b> to save the settings.  |
| <b>Undo</b>                     | N/A   | Click <b>Undo</b> to cancel the changes.   |
| <b>Back</b>                     | N/A   | Click <b>Back</b> to return to last page.  |

OpenVPN Client Advanced Configuration

| Item                              | Setting  |
|-----------------------------------|--|
| ▶ TLS Cipher                      | None ▾   |
| ▶ TLS Auth. Key(Optional)         | <div style="border: 1px solid #ccc; height: 40px; width: 100%;"></div><br>(Optional) |
| ▶ User Name(Optional)             | <input type="text"/> (Optional)  |
| ▶ Password(Optional)              | <input type="text"/> (Optional)  |
| ▶ Bridge TAP to                   | VLAN 1 ▾   |
| ▶ Firewall Protection             | <input type="checkbox"/> Enable  |
| ▶ Client IP Address               | Dynamic IP ▾   |
| ▶ Tunnel MTU                      | <input type="text" value="1500"/>  |
| ▶ Tunnel UDP Fragment             | <input type="text" value="1500"/>  |
| ▶ Tunnel UDP MSS-Fix              | <input type="checkbox"/> Enable  |
| ▶ nsCertType Verification         | <input type="checkbox"/> Enable  |
| ▶ TLS Renegotiation Time(seconds) | <input type="text" value="3600"/> (seconds)  |
| ▶ Connection Retry(seconds)       | <input type="text" value="-1"/> (seconds)  |
| ▶ DNS                             | Automatically ▾  |
| ▶ Additional Configuration        | <div style="border: 1px solid #ccc; height: 40px; width: 100%;"></div>               |

4.1.3 L2TP

| <input type="checkbox"/> Configuration <span style="float: right;">[ Help ]</span>   |                                 |           |            |                |               |        |        |         |
|--|---------------------------------|-----------|------------|----------------|---------------|--------|--------|---------|
| Item   | Setting                         |           |            |                |               |        |        |         |
| ▶ L2TP   | <input type="checkbox"/> Enable |           |            |                |               |        |        |         |
| ▶ Client   | Client ▾                        |           |            |                |               |        |        |         |
| <input type="checkbox"/> L2TP Client Configuration   |                                 |           |            |                |               |        |        |         |
| Item   | Setting                         |           |            |                |               |        |        |         |
| ▶ L2TP Client  | <input type="checkbox"/> Enable |           |            |                |               |        |        |         |
| <input type="checkbox"/> L2TP Client List & Status <input type="button" value="Add"/> <input type="button" value="Delete"/> <input type="button" value="Refresh"/> |                                 |           |            |                |               |        |        |         |
| ID   | Tunnel Name                     | Interface | Virtual IP | Remote IP/FQDN | Remote Subnet | Status | Enable | Actions |

Layer 2 Tunneling Protocol (L2TP) is a tunneling protocol used to support virtual private networks (VPNs) or as part of the delivery of services by ISPs. It does not provide any encryption or confidentiality by itself. Rather, it relies on an encryption protocol that it passes within the tunnel to provide privacy. This Router can only behave as a L2TP client for a L2TP VPN tunnel.

**L2TP Client:** It can be mobile users or gateways in remote offices with dynamic IP. To setup tunnel, it should get “user name”, “password” and server’s global IP. In addition, it is required to identify the operation mode for each tunnel as main connection, failover for another tunnel to increase overall bandwidth. It needs to decide “Default Gateway” or “Remote Subnet” for packet flow. Moreover, you can also define what kind of traffics will pass through the L2TP tunnel in the “Default Gateway / Remote Subnet” parameter.



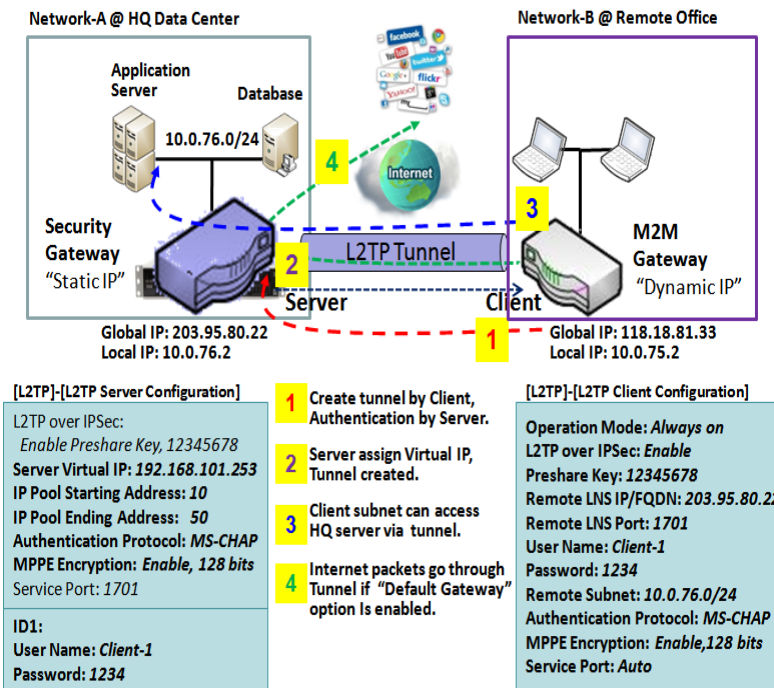

Besides, for the L2TP client peer, a Remote Subnet item is required. It is for the Intranet of L2TP server peer. So, at L2TP client peer, the packets whose destination is in the dedicated subnet will be transferred via the L2TP tunnel. Others will be transferred based on current routing policy of the gateway at L2TP client peer. But, if you entered 0.0.0.0/0 in the Remote Subnet field, it will be treated as a "Default Gateway" setting for the L2TP client peer, all packets, including the Internet accessing of L2TP client peer, will go through the established L2TP tunnel. That means the remote L2TP server peer controls the flow of any packets from the L2TP client peer. Certainly, those packets come through the L2TP tunnel.

## L2TP Setting

Go to **Security > VPN > L2TP** tab.

The L2TP setting allows user to create and configure L2TP tunnels.

## Enable L2TP

| Configuration [ Help ] |                                 |
|------------------------|---------------------------------|
| Item                   | Setting                         |
| L2TP                   | <input type="checkbox"/> Enable |
| Client                 | Client ▾                        |

| Enable L2TP Window |                       |   |
|--------------------|-----------------------|---|
| Item               | Value setting         | Description   |
| L2TP               | Unchecked by default  | Click the <b>Enable</b> box to activate L2TP function.  |
| Client             | A Must filled setting | Specify the role of L2TP. Only <b>Client</b> role is available for this gateway. Below are the configuration windows for L2TP Client. |
| Save               | N/A                   | Click <b>Save</b> button to save the settings   |

**As a L2TP Client**

| L2TP Client Configuration |                                 |
|---------------------------|---------------------------------|
| Item                      | Setting                         |
| ▶ L2TP Client             | <input type="checkbox"/> Enable |

| L2TP Client Configuration |                                 |  |
|---------------------------|---------------------------------|--|
| Item Setting              | Value setting                   | Description  |
| L2TP Client               | The box is unchecked by default | Check the <b>Enable</b> box to enable L2TP client role of the gateway. |
| Save                      | N/A                             | Click <b>Save</b> button to save the settings.                         |
| Undo                      | N/A                             | Click <b>Undo</b> button to cancel the settings.                       |

**Create/Edit L2TP Client**

| L2TP Client List & Status |             |                                    |                                       |  |               |        |        |         |
|---------------------------|-------------|------------------------------------|---------------------------------------|--|---------------|--------|--------|---------|
|                           |             | <input type="button" value="Add"/> | <input type="button" value="Delete"/> | <input type="button" value="Refresh"/> |               |        |        |         |
| ID                        | Tunnel Name | Interface                          | Virtual IP                            | Remote IP/FQDN                         | Remote Subnet | Status | Enable | Actions |

When **Add/Edit** button is applied, a series of configuration screen will appear. You can add up to 8 L2TP Clients.

| L2TP Client Configuration       |   |
|---------------------------------|---|
| Item                            | Setting   |
| ▶ Tunnel Name                   | L2TP #1   |
| ▶ Interface                     | WAN1 ▼  |
| ▶ Operation Mode                | Always on ▼   |
| ▶ L2TP over IPsec               | <input type="checkbox"/> Enable Preshared Key <input type="text"/> (Min. 8 characters)  |
| ▶ Remote LNS IP/FQDN            | <input type="text"/>  |
| ▶ Remote LNS Port               | 1701  |
| ▶ User Name                     | <input type="text"/>  |
| ▶ Password                      | <input type="text"/>  |
| ▶ Tunneling Password (Optional) | <input type="text"/>  |
| ▶ Remote Subnet                 | <input type="text"/>  |
| ▶ Authentication Protocol       | <input type="checkbox"/> PAP <input type="checkbox"/> CHAP <input type="checkbox"/> MS-CHAP <input type="checkbox"/> MS-CHAP v2 |
| ▶ MPPE Encryption               | <input type="checkbox"/> Enable   |
| ▶ LCP Echo Type                 | Auto ▼<br>Interval <input type="text" value="30"/> seconds Max. Failure Time <input type="text" value="6"/> times               |
| ▶ Service Port                  | Auto ▼ <input type="text" value="0"/>   |
| ▶ Tunnel                        | <input type="checkbox"/> Enable   |

## L2TP Client Configuration

| Item Setting       | Value setting   | Description   |
|--------------------|---|---|
| Tunnel Name        | A Must filled setting   | Enter a tunnel name. Enter a name that is easy for you to identify.<br><b>Value Range:</b> 1 ~ 32 characters.   |
| Interface          | A Must filled setting   | Define the selected interface to be the used for this L2TP tunnel<br>(WAN-1 is available only when WAN-1 interface is enabled)<br>The same applies to other WAN interfaces (e.g. WAN-2).  |
| Operation Mode     | 1. A Must filled setting<br>2. Always on is selected by default | Define operation mode for the L2TP Tunnel. It can be <b>Always On</b> , or <b>Failover</b> .<br>If this tunnel is set as a failover tunnel, you need to further select a primary tunnel from which to failover to.<br>Note: <b>Failover</b> mode is not available for the router with single WAN. |
| L2TP over IPsec    | The box is unchecked by default                                 | Check the <b>Enable</b> box to activate L2TP over IPsec, and further specify a Pre-shared Key (8 ~ 32 characters).  |
| Remote LNS IP/FQDN | A Must filled setting   | Enter the public IP address or the FQDN of the L2TP server.   |

|                                     |  |   |
|-------------------------------------|--|---|
| <b>Remote LNS Port</b>              | 1. A Must filled setting<br>2. <b>1701</b> is set by default | Enter the Remote LNS Port for this L2TP tunnel.<br><b><i>Value Range: 1 ~ 65535.</i></b>  |
| <b>User Name</b>                    | A Must filled setting  | Enter the <b>User Name</b> for this L2TP tunnel to be authenticated when connect to L2TP server.<br><b><i>Value Range: 1 ~ 32 characters.</i></b>   |
| <b>Password</b>                     | A Must filled setting  | Enter the <b>Password</b> for this L2TP tunnel to be authenticated when connect to L2TP server.   |
| <b>Tunneling Password(Optional)</b> | The box is unchecked by default                              | Enter the <b>Tunneling Password</b> for this L2TP tunnel to authenticate.   |
| <b>Remote Subnet</b>                | A Must filled setting  | Specify the remote subnet for this L2TP tunnel to reach L2TP server. The Remote Subnet format must be IP address/netmask (e.g. 10.0.0.2/24). It is for the Intranet of L2TP VPN server. So, at L2TP client peer, the packets whose destination is in the dedicated subnet will be transferred via the L2TP VPN tunnel. Others will be transferred based on current routing policy of the security gateway at L2TP client peer.<br>If you entered 0.0.0.0/0 in the Remote Subnet field, it will be treated as a default gateway setting for the L2TP client peer, all packets, including the Internet accessing of L2TP Client peer, will go through the established L2TP VPN tunnel. That means the remote L2TP VPN server controls the flow of any packets from the L2TP client peer. Certainly, those packets come through the L2TP VPN tunnel. |
| <b>Authentication Protocol</b>      | 1. A Must filled setting<br>2. Unchecked by default          | Specify one ore multiple <b>Authentication Protocol</b> for this L2TP tunnel. Available authentication methods are <b>PAP / CHAP / MS-CHAP / MS-CHAP v2.</b>  |
| <b>MPPE Encryption</b>              | 1. Unchecked by default<br>2. an optional setting            | Specify whether L2TP server supports <b>MPPE Protocol</b> . Click the <b>Enable</b> box to enable MPPE.<br>Note: when MPPE Encryption is enabled, the Authentication Protocol <b>PAP / CHAP</b> options will not be available.  |
| <b>LCP Echo Type</b>                | 1. Auto is set by default                                    | Specify the LCP Echo Type for this L2TP tunnel. It can be <b>Auto, User-defined, or Disable.</b><br><b>Auto:</b> the system sets the Interval and Max. Failure Time.<br><b>User-defined:</b> enter the Interval and Max. Failure Time. The default value for Interval is 30 seconds, and Maximum Failure Times is 6 Times.<br><b>Disable:</b> disable the LCP Echo.<br><b><i>Value Range: 1 ~ 99999 for Interval Time, 1~999 for Failure Time.</i></b>  |
| <b>Service Port</b>                 | A Must filled setting  | Specify the <b>Service Port</b> for this L2TP tunnel to use. It can be <b>Auto, (1701) for Cisco,</b> or <b>User-defined.</b><br><b>Auto:</b> The system determines the service port.<br><b>1701 (for Cisco):</b> The system use port 1701 for connecting with CISCO L2TP Server.<br><b>User-defined:</b> Enter the service port. The default value is 0.<br><b><i>Value Range: 0 ~ 65535.</i></b>  |

|               |                      |   |
|---------------|----------------------|---|
| <b>Tunnel</b> | Unchecked by default | Check the <b>Enable</b> box to enable this L2TP tunnel. |
| <b>Save</b>   | N/A                  | Click <b>Save</b> button to save the settings.          |
| <b>Undo</b>   | N/A                  | Click <b>Undo</b> button to cancel the settings.        |

#### 4.1.4 PPTP

▢ Configuration [ Help ]

| Item     | Setting                         |
|----------|---------------------------------|
| ▶ PPTP   | <input type="checkbox"/> Enable |
| ▶ Client | Client ▾                        |

▢ PPTP Client Configuration

| Item          | Setting                         |
|---------------|---------------------------------|
| ▶ PPTP Client | <input type="checkbox"/> Enable |

▢ PPTP Client List & Status
Add
Delete
Refresh

| ID | Tunnel Name | Interface | Virtual IP | Remote IP/FQDN | Remote Subnet | Status | Enable | Actions |
|----|-------------|-----------|------------|----------------|---------------|--------|--------|---------|
|    |             |           |            |                |               |        |        |         |

Point-to-Point Tunneling Protocol (PPTP) is a method for implementing virtual private networks. PPTP uses a control channel over TCP and a GRE tunnel operating to encapsulate PPP packets. It is a client-server based technology. There are various levels of authentication and encryption for PPTP tunneling, usually natively as standard features of the Windows PPTP stack. The security gateway can only play "PPTP Client" role for a PPTP VPN tunnel. PPTP tunnel process is nearly the same as L2TP.

**PPTP Client:** It can be mobile users or gateways in remote offices with dynamic IP. To setup tunnel, it should get "user name", "password" and server's global IP. In addition, it is required to identify the operation mode for each tunnel as main connection, failover for another tunnel to increase overall bandwidth. It needs to decide "Default Gateway" or "Remote Subnet" for packet flow. Moreover, you can also define what kind of traffics will pass through the PPTP tunnel in the "Default Gateway / Remote Subnet" parameter.

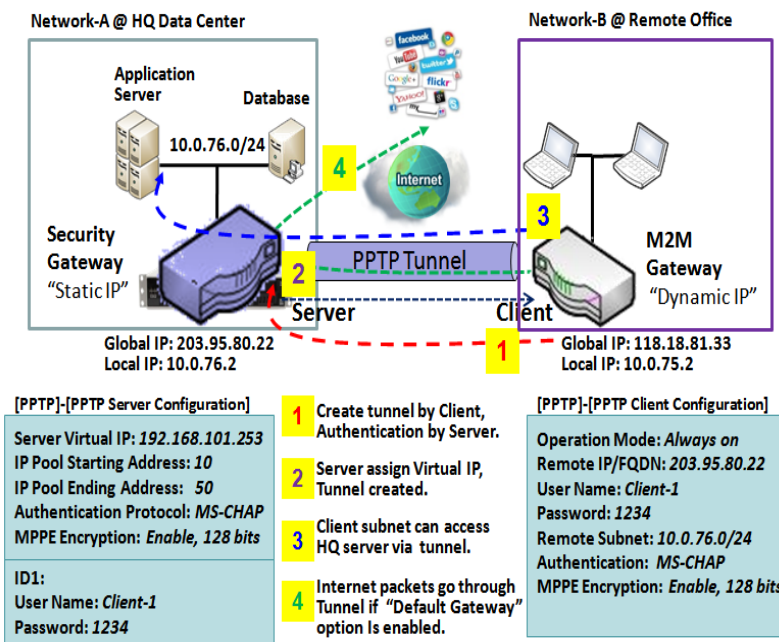

Besides, for the PPTP client peer, a Remote Subnet item is required. It is for the Intranet of PPTP server peer. So, at PPTP client peer, the packets whose destination is in the dedicated subnet will be transferred via the PPTP tunnel. Others will be transferred based on current routing policy of the gateway at PPTP client peer. But, if you entered 0.0.0.0/0 in the Remote Subnet field, it will be treated as a "Default Gateway" setting for the PPTP client peer, all packets, including the Internet accessing of PPTP client peer, will go through the established PPTP tunnel. That means the remote PPTP server peer controls the flow of any packets from the PPTP client peer. Certainly, those packets come through the PPTP tunnel.

## PPTP Setting

Go to **Security > VPN > PPTP** tab.

The PPTP setting allows user to create and configure PPTP tunnels.

## Enable PPTP

| Configuration [ Help ] |                                 |
|------------------------|---------------------------------|
| Item                   | Setting                         |
| PPTP                   | <input type="checkbox"/> Enable |
| Client                 | Client ▾                        |

### Enable PPTP Window

| Item   | Value setting        | Description  |
|--------|----------------------|--|
| PPTP   | Unchecked by default | Click the <b>Enable</b> box to activate PPTP function.   |
| Client | A Must fill setting  | Specify the role of PPTP. Only <b>Client</b> role is available for this router. Below are the configuration windows for PPTP Client. |
| Save   | N/A                  | Click <b>Save</b> button to save the settings.   |

## As a PPTP Client

| PPTP Client Configuration |                                 |
|---------------------------|---------------------------------|
| Item                      | Setting                         |
| ▶ PPTP Client             | <input type="checkbox"/> Enable |

| PPTP Client Configuration |                      |   |
|---------------------------|----------------------|---|
| Item                      | Value setting        | Description   |
| PPTP Client               | Unchecked by default | Check the <b>Enable</b> box to enable PPTP client role of the router. |
| Save                      | N/A                  | Click <b>Save</b> button to save the settings.                        |
| Undo                      | N/A                  | Click <b>Undo</b> button to cancel the settings.                      |

## Create/Edit PPTP Client

| PPTP Client List & Status <input type="button" value="Add"/> <input type="button" value="Delete"/> <input type="button" value="Refresh"/> |             |           |            |                |               |        |        |         |
|---|-------------|-----------|------------|----------------|---------------|--------|--------|---------|
| ID  | Tunnel Name | Interface | Virtual IP | Remote IP/FQDN | Remote Subnet | Status | Enable | Actions |

When **Add/Edit** button is applied, a series PPTP Client Configuration will appear.

| PPTP Client Configuration |  |
|---------------------------|--|
| Item                      | Setting  |
| ▶ Tunnel Name             | PPTP #1 <input type="text"/>   |
| ▶ Interface               | WAN1 <input type="button" value="v"/>  |
| ▶ Operation Mode          | Always on <input type="button" value="v"/>   |
| ▶ Remote IP/FQDN          | <input type="text"/>   |
| ▶ User Name               | <input type="text"/>   |
| ▶ Password                | <input type="text"/>   |
| ▶ Remote Subnet           | <input type="text"/>   |
| ▶ Authentication Protocol | <input type="checkbox"/> PAP <input type="checkbox"/> CHAP <input type="checkbox"/> MS-CHAP <input type="checkbox"/> MS-CHAP v2                  |
| ▶ MPPE Encryption         | <input type="checkbox"/> Enable  |
| ▶ LCP Echo Type           | Auto <input type="button" value="v"/><br>Interval <input type="text" value="30"/> seconds Max. Failure Time <input type="text" value="6"/> times |
| ▶ Tunnel                  | <input type="checkbox"/> Enable  |

| PPTP Client Configuration Window |  |   |
|----------------------------------|--|---|
| Item                             | Value setting  | Description   |
| Tunnel Name                      | A Must fill setting  | Enter a tunnel name. Enter a name that is easy for you to identify.<br><b>Value Range: 1 ~ 32 characters.</b>   |
| Interface                        | 1. A Must fill setting<br>2. WAN1 is selected by default             | Define the selected interface to be the used for this PPTP tunnel ( <b>WAN-1</b> is available only when WAN-1 interface is enabled)<br>The same applies to other WAN interfaces (e.g. <b>WAN-2</b> ).   |
| Operation Mode                   | 1. A Must fill setting<br>2. <b>Always on</b> is selected by default | Define operation mode for the PPTP Tunnel. It can be <b>Always On</b> , or <b>Failover</b> .<br>If this tunnel is set as a failover tunnel, you need to further select a primary tunnel from which to failover to.<br>Note: <b>Failover</b> mode is not available for the router with single WAN.   |
| Remote IP/FQDN                   | 1. A Must fill setting.<br>2. Format can be a ipv4 address or FQDN   | Enter the public IP address or the FQDN of the PPTP server.   |
| User Name                        | A Must fill setting  | Enter the <b>User Name</b> for this PPTP tunnel to be authenticated when connect to PPTP server.<br><b>Value Range: 1 ~ 32 characters.</b>  |
| Password                         | A Must fill setting  | Enter the <b>Password</b> for this PPTP tunnel to be authenticated when connect to PPTP server.   |
| Remote Subnet                    | A Must fill setting  | Specify the remote subnet for this PPTP tunnel to reach PPTP server.<br>The Remote Subnet format must be IP address/netmask (e.g. 10.0.0.2/24).<br>It is for the Intranet of PPTP VPN server. So, at PPTP client peer, the packets whose destination is in the dedicated subnet will be transferred via the PPTP VPN tunnel. Others will be transferred based on current routing policy of the security gateway at PPTP client peer.<br><br>If you entered 0.0.0.0/0 in the Remote Subnet field, it will be treated as a default gateway setting for the PPTP client peer, all packets, including the Internet accessing of PPTP Client peer, will go through the established PPTP VPN tunnel. That means the remote PPTP VPN server controls the flow of any packets from the PPTP client peer. Certainly, those packets come through the PPTP VPN tunnel. |
| Authentication Protocol          | 1. A Must fill setting<br>2. Unchecked by default                    | Specify one ore multiple <b>Authentication Protocol</b> for this PPTP tunnel.<br>Available authentication methods are <b>PAP / CHAP / MS-CHAP / MS-CHAP v2</b> .  |
| MPPE Encryption                  | 1. Unchecked by default<br>2. an optional setting                    | Specify whether PPTP server supports <b>MPPE Protocol</b> . Click the <b>Enable</b> box to enable MPPE.<br>Note: when MPPE Encryption is enabled, the Authentication Protocol <b>PAP / CHAP</b> options will not be available.  |
| LCP Echo Type                    | Auto is set by default   | Specify the LCP Echo Type for this PPTP tunnel. It can be <b>Auto</b> , <b>User-defined</b> , or <b>Disable</b> .<br><b>Auto</b> : the system sets the Interval and Max. Failure Time.<br><b>User-defined</b> : enter the Interval and Max. Failure Time. The default value for Interval is 30 seconds, and Maximum Failure Times is 6 Times.<br><b>Disable</b> : disable the LCP Echo.<br><b>Value Range: 1 ~ 99999 for Interval Time, 1~999 for Failure Time.</b>   |



|               |                      |  |
|---------------|----------------------|--|
| <b>Tunnel</b> | Unchecked by default | Check the <b>Enable</b> box to enable this PPTP tunnel.  |
| <b>Save</b>   | N/A                  | Click <b>Save</b> button to save the settings.           |
| <b>Undo</b>   | N/A                  | Click <b>Undo</b> button to cancel the settings.         |
| <b>Back</b>   | N/A                  | Click <b>Back</b> button to return to the previous page. |

### 4.1.5 GRE

▢ Configuration
[ Help ]

| Item                          | Setting  |
|-------------------------------|--|
| ▶ GRE Tunnel                  | <input type="checkbox"/> Enable                      |
| ▶ Max. Concurrent GRE Tunnels | <input style="width: 40px;" type="text" value="32"/> |

▢ GRE Tunnel List

| ID | Tunnel Name | Interface | Operation Mode | Tunnel IP | Remote IP | MTU | Key | TTL | Keep-alive | Remote Subnet | Enable | Actions |
|----|-------------|-----------|----------------|-----------|-----------|-----|-----|-----|------------|---------------|--------|---------|
|    |             |           |                |           |           |     |     |     |            |               |        |         |

Generic Routing Encapsulation (GRE) is a tunneling protocol developed by Cisco Systems that encapsulates a wide variety of network layer protocols inside virtual point-to-point links over an Internet Protocol internetwork.

Deploy an ICR-1601 router for remote site and establish a virtual private network with control center by using GRE tunneling. So, all client hosts behind ICR-1601 router can make data communication with server hosts behind control center router.

GRE Tunneling is similar to IPSec Tunneling, client requesting the tunnel establishment with the server. Both the client and the server must have a Static IP or a FQDN. Any peer router can be worked as either a client or a server, even using the same set of configuration rule.

## GRE Tunnel Scenario

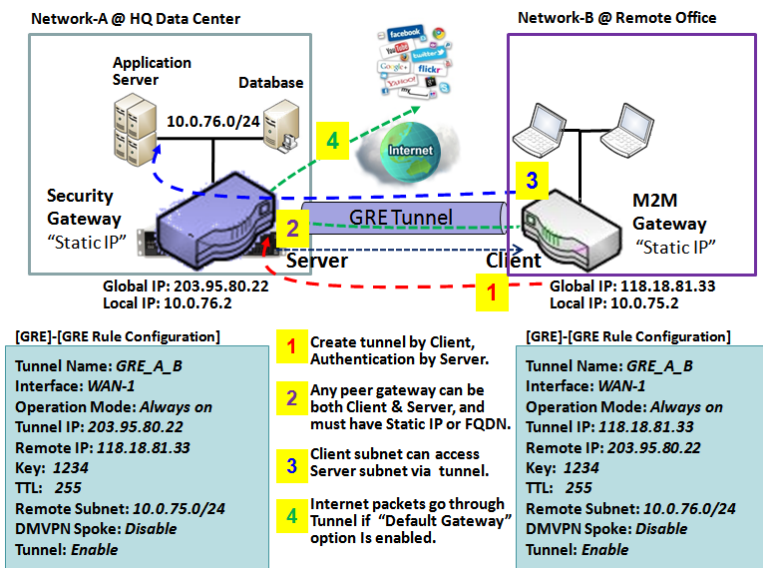

To set up a GRE tunnel, each peer needs to setup its global IP as tunnel IP and fill in the other's global IP as remote IP. Besides, each peer must further specify the Remote Subnet item. It is for the Intranet of GRE server peer. So, at GRE client peer, the packets whose destination is in the dedicated subnet will be transferred via the GRE tunnel. Others will be transferred based on current routing policy of the gateway at GRE client peer. But, if you entered 0.0.0.0/0 in the Remote Subnet field, it will be treated as a "Default Gateway" setting for the GRE client peer, all packets, including the Internet accessing of GRE client peer, will go

through the established GRE tunnel. That means the remote GRE server peer controls the flow of any packets from the GRE client peer. Certainly, those packets come through the GRE tunnel.

If the GRE server supports DMVPN Hub function, like Cisco router as the VPN concentrator, the GRE client can active the DMVPN spoke function here since it is implemented by GRE over IPsec tunneling.

## GRE Setting

Go to **Security > VPN > GRE** tab.

The GRE setting allows user to create and configure GRE tunnels.

## Enable GRE

| Configuration <span style="float: right;">[ Help ]</span> |                                 |
|---|---------------------------------|
| Item  | Setting                         |
| GRE Tunnel  | <input type="checkbox"/> Enable |
| Max. Concurrent GRE Tunnels                               | <input type="text" value="32"/> |

| Enable GRE Window           |                                   |  |
|-----------------------------|-----------------------------------|--|
| Item                        | Value setting                     | Description  |
| GRE Tunnel                  | Unchecked by default              | Click the <b>Enable</b> box to enable GRE function.  |
| Max. Concurrent GRE Tunnels | Depends on Product specification. | The specified value will limit the maximum number of simultaneous GRE tunnel connection. The default value can be different for the purchased model. |

|             |     |   |
|-------------|-----|---|
| <b>Save</b> | N/A | Click <b>Save</b> button to save the settings   |
| <b>Undo</b> | N/A | Click <b>Undo</b> button to cancel the settings |

## Create/Edit GRE tunnel

| <input type="checkbox"/> GRE Tunnel List <input type="button" value="Add"/> <input type="button" value="Delete"/> |             |           |                |           |           |     |     |     |            |               |        |         |
|---|-------------|-----------|----------------|-----------|-----------|-----|-----|-----|------------|---------------|--------|---------|
| ID  | Tunnel Name | Interface | Operation Mode | Tunnel IP | Remote IP | MTU | Key | TTL | Keep-alive | Remote Subnet | Enable | Actions |

When **Add/Edit** button is applied, a GRE Rule Configuration screen will appear.

| GRE Rule Configuration <span style="float: right;">[ Help ]</span> |  |
|--|--|
| Item   | Setting  |
| ▶ Tunnel Name  | <input type="text" value="GRE #1"/>  |
| ▶ Interface  | <input type="text" value="WAN1"/> ▼  |
| ▶ Operation Mode   | <input type="text" value="Always on"/> ▼   |
| ▶ Tunnel IP  | IP: <input type="text"/> MASK: <input type="text" value="-- select one --"/> ▼ (Optional)  |
| ▶ Remote IP  | <input type="text"/>   |
| ▶ MTU  | <input type="text"/>   |
| ▶ Key  | <input type="text"/> (Optional)  |
| ▶ TTL  | <input type="text"/>   |
| ▶ Keep alive   | <input type="checkbox"/> Enable<br><input type="text" value="Ping IP"/> ▼ <input type="text"/> Interval <input type="text" value="5"/> (seconds) |
| ▶ Remote Subnet  | <input type="text"/>   |
| ▶ DMVPN Spoke  | <input type="checkbox"/> Enable  |
| ▶ IPSec Pre-shared Key   | <input type="text"/> (Min. 8 characters)   |
| ▶ IPSec NAT Traversal  | <input type="checkbox"/> Enable  |
| ▶ IPSec Encapsulation Mode   | <input type="text" value="Transport Mode"/> ▼  |
| ▶ Tunnel   | <input type="checkbox"/> Enable  |

| GRE Rule Configuration Window |   |  |
|-------------------------------|---|--|
| Item                          | Value setting   | Description  |
| Tunnel Name                   | A Must fill setting   | Enter a tunnel name. Enter a name that is easy for you to identify.<br><b>Value Range: 1 ~ 9 characters.</b>   |
| Interface                     | 1. A Must fill setting<br>2. <b>WAN 1</b> is selected by default          | Select the interface on which GRE tunnel is to be established. It can be the available WAN and LAN interfaces.   |
| Operation Mode                | 1. A Must fill setting<br>2. <b>Always on</b> is selected by default      | Define operation mode for the GRE Tunnel. It can be <b>Always On</b> , or <b>Failover</b> . If this tunnel is set as a failover tunnel, you need to further select a primary tunnel from which to failover to.<br>Note: <b>Failover</b> mode is not available for the router with single WAN.  |
| Tunnel IP                     | An Optional setting   | Enter the Tunnel IP address and corresponding subnet mask.   |
| Remote IP                     | A Must fill setting   | Enter the Remote IP address of remote GRE tunnel gateway. Normally this is the public IP address of the remote GRE gateway.  |
| MTU                           | 1. A Must filled setting<br>2. <b>Auto</b> (value zero) is set by default | <b>MTU</b> refers to Maximum Transmission Unit. It specifies the largest packet size permitted for Internet transmission.<br>When set to <b>Auto</b> (value '0'), the router selects the best MTU for best Internet connection performance.<br><b>Value Range: 0 ~ 1500.</b>   |
| Key                           | An Optional setting   | Enter the Key for the GRE connection.<br><b>Value Range: 0 ~ 9999999999.</b>   |
| TTL                           | 1. A Must fill setting<br>2. 1 to 255 range                               | Specify <b>TTL</b> hop-count value for this GRE tunnel.<br><b>Value Range: 1 ~ 255.</b>  |
| Keep alive                    | 1. Unchecked by default<br>2. 5s is set by default                        | Check the <b>Enable</b> box to enable Keep alive function.<br>Select Ping IP to keep live and enter the IP address to ping.<br>Enter the ping time interval in seconds.<br><b>Value Range: 5 ~ 999 seconds.</b>  |
| Remote Subnet                 | A Must fill setting   | Specify the remote subnet for this GRE tunnel.<br>The Remote Subnet format must be IP address/netmask (e.g. 10.0.0.2/24). It is for the Intranet of GRE server peer. So, at GRE client peer, the packets whose destination is in the dedicated subnet will be transferred via the GRE tunnel. Others will be transferred based on current routing policy of the security gateway at GRE client peer.<br><br>If you entered 0.0.0.0/0 in the Remote Subnet field, it will be treated as a default gateway setting for the GRE client peer, all packets, including the Internet accessing of GRE client peer, will go through the established GRE tunnel. That means the remote GRE server peer controls the flow of any packets from the GRE client peer. Certainly, those packets come through the GRE tunnel. |
| DMVPN Spoke                   | Unchecked by default  | Specify whether the router will support DMVPN Spoke for this GRE tunnel.<br>Check Enable box to enable DMVPN Spoke.  |
| IPSec Pre-shared Key          | A Must fill setting   | Enter a DMVPN spoke authentication Pre-shared Key ( <b>8 ~ 32 characters</b> ).<br>Note: Pre-shared Key is available only when DMVPN Spoke is enabled.   |
| IPSec NAT Traversal           | Unchecked by default  | Check <b>Enable</b> box to enable NAT-Traversal.<br>Note: IPSec NAT Traversal will not be available when DMVPN is not enabled.   |

|                                 |                      |  |
|---------------------------------|----------------------|--|
| <b>IPSec Encapsulation Mode</b> | Unchecked by default | Specify IPSec Encapsulation Mode from the dropdown box. There are <b>Transport mode</b> and <b>Tunnel mode</b> supported.<br>Note: IPSec Encapsulation Mode will not be available when DMVPN is not enabled. |
| <b>Tunnel</b>                   | Unchecked by default | Check <b>Enable</b> box to enable this GRE tunnel.   |
| <b>Save</b>                     | N/A                  | Click <b>Save</b> button to save the settings.   |
| <b>Undo</b>                     | N/A                  | Click <b>Undo</b> button to cancel the settings.   |
| <b>Back</b>                     | N/A                  | Click <b>Back</b> button to return to the previous page.   |

## 4.2 Firewall

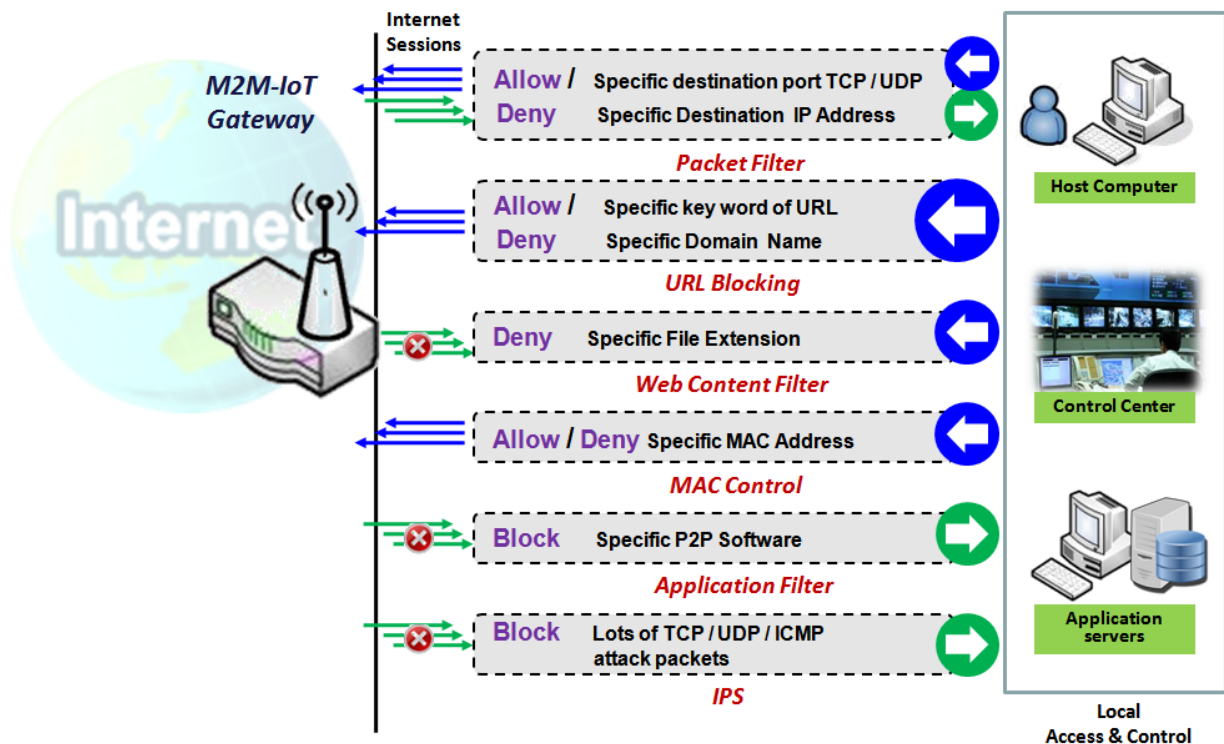

The firewall functions include Packet Filter, URL Blocking, Content Filter, MAC Control, Application Filter, IPS and some firewall options. The supported function can be different for the purchased router.

### 4.2.1 Packet Filter

| Configuration <span style="float: right;">[ Help ]</span> |  |
|---|--|
| Item  | Setting                                    |
| ▶ Packet Filters  | <input checked="" type="checkbox"/> Enable |
| ▶ Black List / White List                                 | Deny those match the following rules. ▼    |
| ▶ Log Alert   | <input type="checkbox"/> Log Alert         |

"Packet Filter" function can let you define some filtering rules for incoming and outgoing packets. So the router can control what packets are allowed or blocked to pass through it. A packet filter rule should indicate from and to which interface the packet enters and leaves the router, the source and destination IP addresses, and destination service port type and port number. In addition, the time schedule to which the rule will be active.

### Packet Filter with White List Scenario

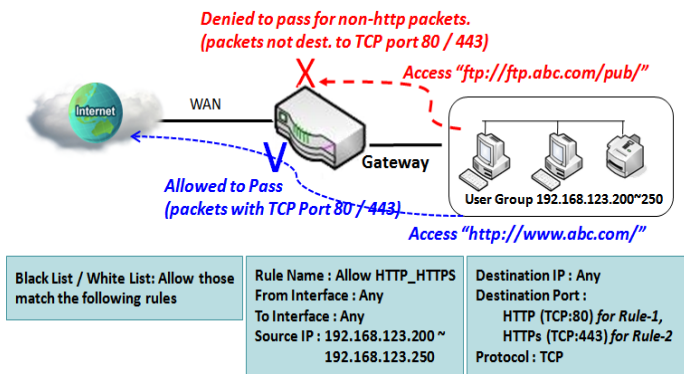

As shown in the diagram, specify "Packet Filter Rule List" as white list (*Allow those match the following rules*) and define the rules. Rule-1 is to allow HTTP packets to pass, and Rule-2 is to allow HTTPS packets to pass.

Under such configuration, the gateway will allow only HTTP and HTTPS packets, issued from the IP range 192.168.123.200 to 250, which are targeted to TCP port 80 or 443 to pass the WAN interface.

### Packet Filter Setting

Go to **Security > Firewall > Packet Filter** Tab.

The packet filter setting allows user to create and customize packet filter policies to allow or reject specific inbound/outbound packets through the router based on their office setting.

### Enable Packet Filter

| <input type="checkbox"/> Configuration <span style="float: right;">[ Help ]</span> |   |
|--|---|
| Item   | Setting                                 |
| ▶ Packet Filters   | <input type="checkbox"/> Enable         |
| ▶ Black List / White List  | Deny those match the following rules. ▾ |
| ▶ Log Alert  | <input type="checkbox"/> Log Alert      |

| Configuration Window    |  |   |
|-------------------------|--|---|
| Item Name               | Value setting  | Description   |
| Packet Filter           | The box is unchecked by default                        | Check the <b>Enable</b> box to activate Packet Filter function  |
| Black List / White List | Deny those match the following rules is set by default | When <b>Deny those match the following rules</b> is selected, as the name suggest, packets specified in the rules will be blocked –black listed. In contrast, with <b>Allow those match the following rules</b> , you can specifically white list the packets to pass and the rest will be blocked. |
| Log Alert               | The box is unchecked by default                        | Check the <b>Enable</b> box to activate Event Log.  |
| Save                    | N/A  | Click <b>Save</b> to save the settings  |
| Undo                    | N/A  | Click <b>Undo</b> to cancel the settings  |

## Create/Edit Packet Filter Rules

The router allows you to customize your packet filtering rules. It supports up to a maximum of 20 filter rule sets.

| ID | Rule Name | From Interface | To Interface | Source IP | Destination IP | Source MAC | Protocol | Source Port | Destination Port | Time Schedule | Enable | Actions |
|----|-----------|----------------|--------------|-----------|----------------|------------|----------|-------------|------------------|---------------|--------|---------|
|----|-----------|----------------|--------------|-----------|----------------|------------|----------|-------------|------------------|---------------|--------|---------|

When **Add** button is applied, **Packet Filter Rule Configuration** screen will appear.

| Item               | Setting                         |
|--------------------|---------------------------------|
| ▶ Rule Name        | Rule1                           |
| ▶ From Interface   | Any                             |
| ▶ To Interface     | Any                             |
| ▶ Source IP        | Any                             |
| ▶ Destination IP   | Any                             |
| ▶ Source MAC       | Any                             |
| ▶ Protocol         | Any(0)                          |
| ▶ Source Port      | User-defined Service [ ] - [ ]  |
| ▶ Destination Port | User-defined Service [ ] - [ ]  |
| ▶ Time Schedule    | (0) Always                      |
| ▶ Rule             | <input type="checkbox"/> Enable |

| Packet Filter Rule Configuration |  |  |
|----------------------------------|--|--|
| Item Name                        | Value setting  | Description  |
| Rule Name                        | 1. String format can be any text<br>2. A Must filled setting     | Enter a packet filter rule name. Enter a name that is easy for you to remember.<br><b>Value Range: 1 ~ 30 characters.</b>  |
| From Interface                   | 1. A Must filled setting<br>2. <b>By default Any is selected</b> | Define the selected interface to be the packet-entering interface of the router. If the packets to be filtered are coming from <b>LAN to WAN</b> then select LAN for this field. Or <b>VLAN-1 to WAN</b> then select <b>VLAN-1</b> for this field. Other examples are VLAN-1 to VLAN-2. VLAN-1 to WAN.<br>Select <b>Any</b> to filter packets coming into the router from any interfaces.<br>Please note that two identical interfaces are not accepted by the router. e.g., VLAN-1 to VLAN-1. |



|                |  |   |
|----------------|--|---|
| To Interface   | <ol style="list-style-type: none"> <li>1. A Must filled setting</li> <li>2. By default Any is selected</li> </ol>    | <p>Define the selected interface to be the packet-leaving interface of the router. If the packets to be filtered are entering from <b>LAN to WAN</b> then select <b>WAN</b> for this field. Or <b>VLAN-1 to WAN</b> then select <b>WAN</b> for this field. Other examples are VLAN-1 to VLAN-2. VLAN-1 to WAN.</p> <p>Select <b>Any</b> to filter packets leaving the router from any interfaces.</p> <p>Please note that two identical interfaces are not accepted by the router. e.g., VLAN-1 to VLAN-1.</p>                                      |
| Source IP      | <ol style="list-style-type: none"> <li>1. A Must filled setting</li> <li>2. By default Any is selected</li> </ol>    | <p>This field is to specify the <b>Source IP address</b>.</p> <p>Select <b>Any</b> to filter packets coming from any IP addresses.</p> <p>Select <b>Specific IP Address</b> to filter packets coming from an IP address.</p> <p>Select <b>IP Range</b> to filter packets coming from a specified range of IP address.</p>   |
| Destination IP | <ol style="list-style-type: none"> <li>1. A Must filled setting</li> <li>2. By default Any is selected</li> </ol>    | <p>This field is to specify the <b>Destination IP address</b>.</p> <p>Select <b>Any</b> to filter packets that are entering to any IP addresses.</p> <p>Select <b>Specific IP Address</b> to filter packets entering to an IP address entered in this field.</p> <p>Select <b>IP Range</b> to filter packets entering to a specified range of IP address entered in this field.</p>   |
| Source MAC     | <ol style="list-style-type: none"> <li>1. A Must filled setting</li> <li>2. By default Any is selected</li> </ol>    | <p>This field is to specify the <b>Source MAC address</b>.</p> <p>Select <b>Any</b> to filter packets coming from any MAC addresses.</p> <p>Select <b>Specific MAC Address</b> to filter packets coming from a MAC address.</p>   |
| Protocol       | <ol style="list-style-type: none"> <li>1. A Must filled setting</li> <li>2. By default Any(0) is selected</li> </ol> | <p>For <b>Protocol</b>, select <b>Any</b> to filter any protocol packets</p> <p>Then for <b>Source Port</b>, select a predefined port dropdown box when <b>Well-known Service</b> is selected, otherwise select <b>User-defined Service</b> and specify a port range.</p> <p>Then for <b>Destination Port</b>, select a predefined port dropdown box when <b>Well-known Service</b> is selected, otherwise select <b>User-defined Service</b> and specify a port range.</p> <p><b>Value Range: 1 ~ 65535 for Source Port, Destination Port.</b></p> |
|                |  | <p>For <b>Protocol</b>, select <b>ICMPv4</b> to filter ICMPv4 packets</p>   |
|                |  | <p>For <b>Protocol</b>, select <b>TCP</b> to filter TCP packets</p> <p>Then for <b>Source Port</b>, select a predefined port dropdown box when <b>Well-known Service</b> is selected, otherwise select <b>User-defined Service</b> and specify a port range.</p> <p>Then for <b>Destination Port</b>, select a predefined port dropdown box when <b>Well-known Service</b> is selected, otherwise select <b>User-defined Service</b> and specify a port range.</p> <p><b>Value Range: 1 ~ 65535 for Source Port, Destination Port.</b></p>          |
|                |  | <p>For <b>Protocol</b>, select <b>UDP</b> to filter UDP packets</p> <p>Then for <b>Source Port</b>, select a predefined port dropdown box when <b>Well-known Service</b> is selected, otherwise select <b>User-defined Service</b> and specify a port range.</p> <p>Then for <b>Destination Port</b>, select a predefined port dropdown box when <b>Well-known Service</b> is selected, otherwise select <b>User-defined Service</b> and specify a port range.</p> <p><b>Value Range: 1 ~ 65535 for Source Port, Destination Port.</b></p>          |
|                |  | <p>For <b>Protocol</b>, select <b>GRE</b> to filter GRE packets</p>   |
|                |  | <p>For <b>Protocol</b>, select <b>ESP</b> to filter ESP packets</p>   |

|               |                                  |   |
|---------------|----------------------------------|---|
|               |                                  | For <b>Protocol</b> , select <b>SCTP</b> to filter <b>SCTP</b> packets  |
|               |                                  | For <b>Protocol</b> , select <b>User-defined</b> to filter packets with specified port number. Then enter a port number in <b>Protocol Number</b> box.  |
| Time Schedule | A Must filled setting            | Apply <b>Time Schedule</b> to this rule, otherwise leave it as Always. If the dropdown list is empty ensure <b>Time Schedule</b> is pre-configured. Refer to <b>Object Definition &gt; Scheduling &gt; Configuration</b> tab. |
| Rule          | The box is unchecked by default. | Click <b>Enable</b> box to activate this rule then save the settings.   |
| Save          | N/A                              | Click <b>Save</b> to save the settings  |
| Undo          | N/A                              | Click <b>Undo</b> to cancel the settings  |
| Back          | N/A                              | When the <b>Back</b> button is clicked the screen will return to the Packet Filter Configuration page.  |

### 4.2.2 URL Blocking

"URL Blocking" function can let you define blocking or allowing rules for incoming and outgoing Web request packets. With defined rules, router can control the Web requests containing the complete URL, partial domain name, or pre-defined keywords. For example, one can filter out or allow only the Web requests based on domain input suffixes like .com or .org or keywords like "bct" or "mpe".

An URL blocking rule should specify the URL, partial domain name, or included keywords in the Web requests from and to the router and also the destination service port. Besides, a certain time schedule can be applied to activate the URL Blocking rules during pre-defined time interval(s).

The router will logs and displays the disallowed web accessing requests that matched the defined URL blocking rule in the black-list or in the exclusion of the white-list.

When you choose "Allow all to pass except those match the following rules" for the "URL Blocking Rule List", you are setting the defined URL blocking rules to belong to the black list. The packets, listed in the rule list, will be blocked if one pattern in the requests matches to one rule. Other Web requests can pass through the router. In contrast, when you choose "Deny all to pass except those match the following rules" for the "URL Blocking Rule List", you are setting the defined packet filtering rules to belong to the white list. The Web requests, listed in the rule, will be allowed if one pattern in the requests matches to one rule. Other Web requests will be blocked.

### URL Blocking Rule with Black List

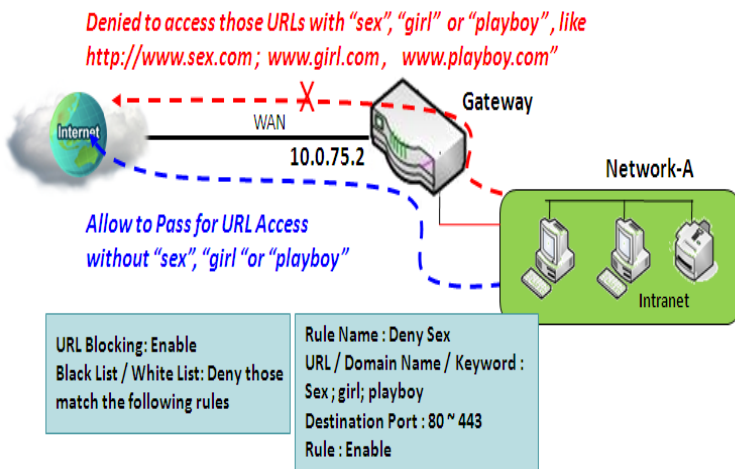

When the administrator of the gateway wants to block the Web requests with some dedicated patterns, he can use the "URL Blocking" function to block specific Web requests by defining the black list as shown in above diagram. Certainly, when the administrator wants to allow only the Web requests with some dedicated patterns to go through the gateway, he can also use the "URL Blocking" function by defining the white list to meet the requirement.

As shown in the diagram, enable the URL blocking function and create the first rule to deny the Web requests with "sex" or "sexygirl" patterns and the other to deny the Web requests with "playboy" pattern to go through the gateway. System will block the Web requests with "sex", "sexygirl" or "playboy" patterns to pass through the gateway.

## URL Blocking Setting

Go to **Security > Firewall > URL Blocking** Tab.

In "URL Blocking" page, there are three configuration windows. They are the "Configuration" window, "URL Blocking Rule List" window, and "URL Blocking Rule Configuration" window.

The "Configuration" window can let you activate the URL blocking function and specify to black listing or to white listing the packets defined in the "URL Blocking Rule List" entry. In addition, log alerting can be enabled to record on-going events for any disallowed Web request packets. Refer to "System Status" in "6.1.1 System Related" section in this user manual for how to view recorded log.

The "URL Blocking Rule List" window lists all your defined URL blocking rule entry. And finally, the "URL Blocking Rule Configuration" window can let you define URL blocking rules. The parameters in a rule include the rule name, the Source IP or MAC, the URL/Domain Name/Keyword, the destination service ports, the integrated time schedule rule and the rule activation.

### Enable URL Blocking

| Configuration <span style="float: right;">[ Help ]</span> |   |
|---|---|
| Item  | Setting                                 |
| ▶ URL Blocking  | <input type="checkbox"/> Enable         |
| ▶ Black List / White List                                 | Deny those match the following rules. ▼ |
| ▶ Log Alert   | <input type="checkbox"/> Enable         |

| Configuration           |   |   |
|-------------------------|---|---|
| Item                    | Value setting   | Description   |
| URL Blocking            | The box is unchecked by default                               | Check the <b>Enable</b> box to activate URL Blocking function.  |
| Black List / White List | <b>Deny those match the following rules</b> is set by default | Specify the URL Blocking Policy, either Black List or White List.<br>Black List: When <b>Deny those match the following rules</b> is selected, as the name suggest, the matched Web request packets will be blocked.<br>White List: When <b>Allow those match the following rules</b> is selected, the matched Web request packets can pass through the Gateway, and the others that don't match the rules will be blocked. |
| Log Alert               | The box is unchecked by default                               | Check the <b>Enable</b> box to activate Event Log.  |
| Save                    | NA  | Click <b>Save</b> button to save the settings   |
| Undo                    | NA  | Click <b>Undo</b> button to cancel the settings   |

### Create/Edit URL Blocking Rules

The Gateway supports up to a maximum of 20 URL blocking rule sets. Ensure that the URL Blocking is enabled before we can create blocking rules.

| <input type="checkbox"/> URL Blocking Rule List <input type="button" value="Add"/> <input type="button" value="Delete"/> |           |           |            |                             |                  |               |        |         |
|--|-----------|-----------|------------|-----------------------------|------------------|---------------|--------|---------|
| ID   | Rule Name | Source IP | Source MAC | URL / Domain Name / Keyword | Destination Port | Time Schedule | Enable | Actions |

When **Add** button is applied, the **URL Blocking Rule Configuration** screen will appear.

| <input type="checkbox"/> URL Blocking Rule Configuration |                                 |
|--|---------------------------------|
| Item   | Setting                         |
| ▶ Rule Name  | Rule1                           |
| ▶ Source IP  | Any                             |
| ▶ Source MAC   | Any                             |
| ▶ URL / Domain Name / Keyword                            |                                 |
| ▶ Destination Port                                       | Any                             |
| ▶ Time Schedule Rule                                     | (0) Always                      |
| ▶ Rule   | <input type="checkbox"/> Enable |

#### URL Blocking Rules Configuration

| Item                               | Value setting  | Description  |
|------------------------------------|--|--|
| <b>Rule Name</b>                   | 1. String format can be any text<br>2. A Must filled setting   | Specify an URL Blocking rule name. Enter a name that is easy for you to understand.  |
| <b>Source IP</b>                   | 1. A Must filled setting<br>2. <b>Any</b> is set by default  | This field is to specify the <b>Source IP address</b> . <ul style="list-style-type: none"> <li>• Select <b>Any</b> to filter packets coming from any IP addresses.</li> <li>• Select <b>Specific IP Address</b> to filter packets coming from an IP address entered in this field.</li> <li>• Select <b>IP Range</b> to filter packets coming from a specified range of IP address entered in this field.</li> </ul> |
| <b>Source MAC</b>                  | 1. A Must filled setting<br>2. <b>Any</b> is set by default  | This field is to specify the <b>Source MAC address</b> . <ul style="list-style-type: none"> <li>• Select <b>Any</b> to filter packets coming from any MAC addresses.</li> <li>• Select <b>Specific MAC Address</b> to filter packets coming from a MAC address entered in this field.</li> </ul>   |
| <b>URL / Domain Name / Keyword</b> | 1. A Must filled setting<br>2. Supports up to a maximum of 10 Keywords in a rule by using the delimiter “;”. | Specify URL, Domain Name, or Keyword list for URL checking. <ul style="list-style-type: none"> <li>• In the <b>Black List</b> mode, if a matched rule is found, the packets will be dropped.</li> <li>• In the <b>White List</b> mode, if a matched rule is found, the packets will be accepted and the others which don’t match any rule will be dropped.</li> </ul>  |

|                           |   |  |
|---------------------------|---|--|
| <b>Destination Port</b>   | 1. A Must filled setting<br>2. <b>Any</b> is set by default | This field is to specify the <b>Destination Port number</b> .<br><ul style="list-style-type: none"> <li>Select <b>Any</b> to filter packets going to any Port.</li> <li>Select <b>Specific Service Port</b> to filter packets going to a specific Port entered in this field.</li> <li>Select <b>Port Range</b> to filter packets going to a specific range of Ports entered in this field.</li> </ul> |
| <b>Time Schedule Rule</b> | A Must filled setting                                       | Apply a specific <b>Time Schedule</b> to this rule; otherwise leave it as <b>(0) Always</b> . If the dropdown list is empty ensure <b>Time Schedule</b> is pre-configured. Refer to <b>Object Definition &gt; Scheduling &gt; Configuration</b> tab.   |
| <b>Rule</b>               | The box is unchecked by default.                            | Click the <b>Enable</b> box to activate this rule.   |
| <b>Save</b>               | NA  | Click the <b>Save</b> button to save the settings.   |
| <b>Undo</b>               | NA  | Click the <b>Undo</b> button to cancel the changes.  |
| <b>Back</b>               | NA  | Click the <b>Back</b> button to return to the URL Blocking Configuration page.   |

### 4.2.3 MAC Control

Configuration
[ Help ]

| Item                         | Setting  |
|------------------------------|--|
| ▶ MAC Control                | <input checked="" type="checkbox"/> Enable   |
| ▶ Black List / White List    | Deny MAC Address Below. ▼  |
| ▶ Log Alert                  | <input type="checkbox"/> Enable  |
| ▶ Known MAC from LAN PC List | 192.168.123.222(RAPET-NB) ▼ <span style="float: right; border: 1px solid #ccc; padding: 2px 5px;">Copy to</span> |

MAC Control Rule List
Add
Delete

| ID | Rule Name | MAC Address | Time Schedule Rule | Enable | Actions |
|----|-----------|-------------|--------------------|--------|---------|
|    |           |             |                    |        |         |

"MAC Control" function allows you to assign the accessibility to the gateway for different users based on device's MAC address. When the administrator wants to reject the traffics from some client hosts with specific MAC addresses, he can use the "MAC Control" function to reject with the black list configuration.

### MAC Control with Black List Scenario

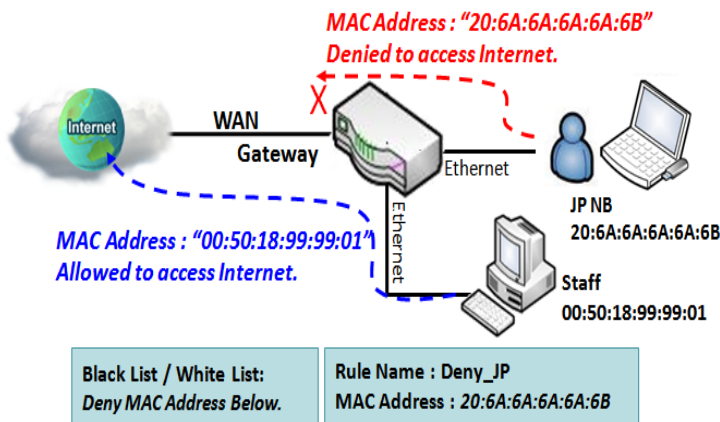

As shown in the diagram, enable the MAC control function and specify the "MAC Control Rule List" is a black list, and configure one MAC control rule for the gateway to deny the connection request from the "JP NB" with its own MAC address 20:6A:6A:6A:6B. System will block the connecting from the "JP NB" to the gateway but allow others.

### MAC Control Setting

Go to **Security > Firewall > MAC Control** Tab.

The MAC control setting allows user to create and customize MAC address policies to allow or reject packets with specific source MAC address.

### Enable MAC Control

| Configuration [ Help ]       |  |
|------------------------------|--|
| Item                         | Setting  |
| ▶ MAC Control                | <input type="checkbox"/> Enable                                      |
| ▶ Black List / White List    | Deny MAC Address Below. ▾  |
| ▶ Log Alert                  | <input type="checkbox"/> Enable                                      |
| ▶ Known MAC from LAN PC List | 192.168.123.222(PETURAR-NB) ▾ <input type="button" value="Copy to"/> |

| Configuration Window    |  |   |
|-------------------------|--|---|
| Item                    | Value setting                            | Description   |
| MAC Control             | The box is unchecked by default          | Check the <b>Enable</b> box to activate the MAC filter function   |
| Black List / White List | Deny MAC Address Below is set by default | When <b>Deny MAC Address Below</b> is selected, as the name suggest, packets specified in the rules will be blocked –black listed. In contrast, with <b>Allow MAC Address Below</b> , you can specifically white list the packets to pass and the rest will be blocked. |
| Log Alert               | The box is unchecked by default          | Check the <b>Enable</b> box to activate to activate Event Log.  |

|                                   |     |   |
|-----------------------------------|-----|---|
| <b>Known MAC from LAN PC List</b> | N/A | Select a MAC Address from LAN Client List. Click the <b>Copy to</b> to copy the selected <b>MAC Address</b> to the filter rule. |
| <b>Save</b>                       | N/A | Click <b>Save</b> to save the settings  |
| <b>Undo</b>                       | N/A | Click <b>Undo</b> to cancel the settings  |

## Create/Edit MAC Control Rules

The router supports up to a maximum of 20 filter rule sets. Ensure that the MAC Control is enabled before we can create control rules.

| <input type="checkbox"/> MAC Control Rule List <input type="button" value="Add"/> <input type="button" value="Delete"/> |           |             |                    |        |         |
|---|-----------|-------------|--------------------|--------|---------|
| ID  | Rule Name | MAC Address | Time Schedule Rule | Enable | Actions |

When **Add** button is applied, **Filter Rule Configuration** screen will appear.

| <input type="checkbox"/> MAC Control Rule Configuration |                                |               |                          |
|---|--------------------------------|---------------|--------------------------|
| Rule Name   | MAC Address (Use : to Compose) | Time Schedule | Enable                   |
| <input type="text" value="Rule1"/>                      | <input type="text"/>           | (0) Always ▾  | <input type="checkbox"/> |
| <input type="button" value="Save"/>                     |                                |               |                          |

| MAC Control Rule Configuration       |  |  |
|--------------------------------------|--|--|
| Item                                 | Value setting  | Description  |
| <b>Rule Name</b>                     | 1. String format can be any text<br>2. A Must fill setting | Enter a MAC Control rule name. Enter a name that is easy for you to remember.  |
| <b>MAC Address (Use: to Compose)</b> | 1. MAC Address string Format<br>2. A Must fill setting     | Specify the <b>Source MAC Address</b> to filter rule.  |
| <b>Time Schedule</b>                 | A Must fill setting  | Apply <b>Time Schedule</b> to this rule; otherwise leave it as <b>(0) Always</b> .<br>If the dropdown list is empty, ensure <b>Time Schedule</b> is pre-configured. Refer to <b>Object Definition &gt; Scheduling &gt; Configuration tab</b> |
| <b>Enable</b>                        | The box is unchecked by default.                           | Click <b>Enable</b> box to activate this rule, and then save the settings.   |
| <b>Save</b>                          | N/A  | Click <b>Save</b> to save the settings   |
| <b>Undo</b>                          | N/A  | Click <b>Undo</b> to cancel the settings   |
| <b>Back</b>                          | N/A  | Click <b>Back</b> to return to the MAC Control Configuration page.   |



4.2.4 IPS

| Configuration [ Help ] |                                 |
|------------------------|---------------------------------|
| Item                   | Setting                         |
| ▶ IPS                  | <input type="checkbox"/> Enable |
| ▶ Log Alert            | <input type="checkbox"/> Enable |

  

| Intrusion Prevention  |  |
|-----------------------|--|
| Item                  | Setting  |
| ▶ SYN Flood Defense   | <input type="checkbox"/> Enable <input type="text" value="300"/> Packets/second (10~10000) |
| ▶ UDP Flood Defense   | <input type="checkbox"/> Enable <input type="text" value="300"/> Packets/second (10~10000) |
| ▶ ICMP Flood Defense  | <input type="checkbox"/> Enable <input type="text" value="300"/> Packets/second (10~10000) |
| ▶ Port Scan Detection | <input type="checkbox"/> Enable <input type="text" value="200"/> Packets/second (10~10000) |

To provide application servers in the Internet, administrator may need to open specific ports for the services. However, there are some risks to always open service ports in the Internet. In order to avoid such attack risks, it is important to enable IPS functions.

Intrusion Prevention System (IPS) is network security appliances that monitor network and/or system activities for malicious activity. The main functions of IPS are to identify malicious activity, log information about this activity, attempt to block/stop it and report it. You can enable the IPS function and check the listed intrusion activities when needed. You can also enable the log alerting so that system will record Intrusion events when corresponding intrusions are detected.

IPS Scenario

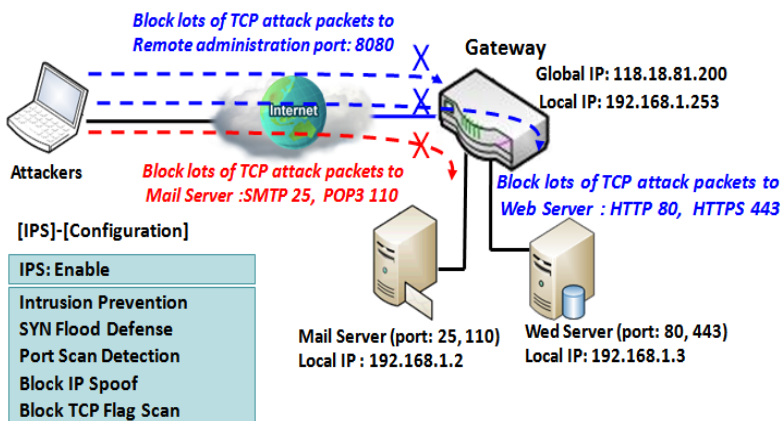

As shown in the diagram, the gateway serves as an E-mail server, Web Server and also provides TCP port 8080 for remote administration. So, remote users or unknown users can request those services from Internet. With IPS enabled, the gateway can detect incoming attack packets, including the TCP ports (25, 80, 110, 443 and 8080) with services. It will block the attack packets and let the normal access to pass through the gateway.

## IPS Setting

Go to **Security > Firewall > IPS** Tab.

The Intrusion Prevention System (IPS) setting allows user to customize intrusion prevention rules to prevent malicious packets.

### Enable IPS Firewall

| Configuration <span style="float: right;">[ Help ]</span> |                                 |
|---|---------------------------------|
| Item  | Setting                         |
| ▶ IPS   | <input type="checkbox"/> Enable |
| ▶ Log Alert   | <input type="checkbox"/> Enable |

| Configuration Window |                                 |  |
|----------------------|---------------------------------|--|
| Item                 | Value setting                   | Description  |
| IPS                  | The box is unchecked by default | Check the <b>Enable</b> box to activate IPS function           |
| Log Alert            | The box is unchecked by default | Check the <b>Enable</b> box to activate to activate Event Log. |
| Save                 | N/A                             | Click <b>Save</b> to save the settings                         |
| Undo                 | N/A                             | Click <b>Undo</b> to cancel the settings                       |

## Setup Intrusion Prevention Rules

The router allows you to select intrusion prevention rules you may want to enable. Ensure that the IPS is enabled before we can enable the defense function.

| Intrusion Prevention   |  |
|------------------------|--|
| Item                   | Setting  |
| ▶ SYN Flood Defense    | <input type="checkbox"/> Enable <input type="text" value="300"/> Packets/second (10~10000) |
| ▶ UDP Flood Defense    | <input type="checkbox"/> Enable <input type="text" value="300"/> Packets/second (10~10000) |
| ▶ ICMP Flood Defense   | <input type="checkbox"/> Enable <input type="text" value="300"/> Packets/second (10~10000) |
| ▶ Port Scan Detection  | <input type="checkbox"/> Enable <input type="text" value="200"/> Packets/second (10~10000) |
| ▶ Block Land Attack    | <input type="checkbox"/> Enable  |
| ▶ Block Ping of Death  | <input type="checkbox"/> Enable  |
| ▶ Block IP Spoof       | <input type="checkbox"/> Enable  |
| ▶ Block TCP Flag Scan  | <input type="checkbox"/> Enable  |
| ▶ Block Smurf          | <input type="checkbox"/> Enable  |
| ▶ Block Traceroute     | <input type="checkbox"/> Enable  |
| ▶ Block Fraggle Attack | <input type="checkbox"/> Enable  |
| ▶ ARP Spoofing Defence | <input type="checkbox"/> Enable <input type="text" value="300"/> Packets/second (10~10000) |

| Setup Intrusion Prevention Rules |   |  |
|----------------------------------|---|--|
| Item Name                        | Value setting   | Description  |
| SYN Flood Defense                | 1. A Must filled setting<br>2. The box is unchecked by default.<br>3. Traffic threshold is set to 300 by default<br>4. The value range can be from 10 to 10000. | Click <b>Enable</b> box to activate this intrusion prevention rule and enter the traffic threshold in this field.                                    |
| UDP Flood Defense                |   | Click <b>Enable</b> box to activate this intrusion prevention rule and enter the traffic threshold in this field.                                    |
| ICMP Flood Defense               |   | Click <b>Enable</b> box to activate this intrusion prevention rule and enter the traffic threshold in this field.<br><b>Value Range: 10 ~ 10000.</b> |
| Port Scan Defection              | 1. A Must filled setting<br>2. The box is unchecked by default.<br>3. Traffic threshold is set to 200 by default<br>4. The value range can be from 10 to 10000. | Click <b>Enable</b> box to activate this intrusion prevention rule and enter the traffic threshold in this field.<br><b>Value Range: 10 ~ 10000.</b> |

|                      |   |   |
|----------------------|---|---|
| Block Land Attack    | The box is unchecked by default.  | Click <b>Enable</b> box to activate this intrusion prevention rule.   |
| Block Ping of Death  |   |   |
| Block IP Spoof       |   |   |
| Block TCP Flag Scan  |   |   |
| Block Smurf          |   |   |
| Block Traceroute     |   |   |
| Block Fraggle Attack |   |   |
| ARP Spoofing Defence | <ol style="list-style-type: none"> <li>1. A Must filled setting</li> <li>2. The box is unchecked by default.</li> <li>3. Traffic threshold is set to 300 by default</li> <li>4. The value range can be from 10 to 10000.</li> </ol> | Click <b>Enable</b> box to activate this intrusion prevention rule and enter the traffic threshold in this field.<br><i><b>Value Range: 10 ~ 10000.</b></i> |
| Save                 | NA  | Click <b>Save</b> to save the settings  |
| Undo                 | NA  | Click <b>Undo</b> to cancel the settings  |

## 4.2.5 Options

| Firewall Options [ Help ] |  |  |  |  |  |  |  |
|---------------------------|--|--|--|--|--|--|--|
| Item                      |  | Setting                                    |  |  |  |  |  |
| ▶ Stealth Mode            |  | <input type="checkbox"/> Enable            |  |  |  |  |  |
| ▶ SPI                     |  | <input checked="" type="checkbox"/> Enable |  |  |  |  |  |
| ▶ Discard Ping from WAN   |  | <input type="checkbox"/> Enable            |  |  |  |  |  |

| Remote Administrator Host Definition |           |          |        |             |              |                          |        |
|--------------------------------------|-----------|----------|--------|-------------|--------------|--------------------------|--------|
| ID                                   | Interface | Protocol | IP     | Subnet Mask | Service Port | Enable                   | Action |
| 1                                    | All WAN   | HTTP     | Any IP | N/A         | 80           | <input type="checkbox"/> | Edit   |
| 2                                    | All WAN   | HTTP     | Any IP | N/A         | 80           | <input type="checkbox"/> | Edit   |
| 3                                    | All WAN   | HTTP     | Any IP | N/A         | 80           | <input type="checkbox"/> | Edit   |
| 4                                    | All WAN   | HTTP     | Any IP | N/A         | 80           | <input type="checkbox"/> | Edit   |
| 5                                    | All WAN   | HTTP     | Any IP | N/A         | 80           | <input type="checkbox"/> | Edit   |

There are some additional useful firewall options in this page:

**Stealth Mode** lets router not to respond to port scans from the WAN so that makes it less susceptible to discovery and attacks on the Internet. "SPI" enables router to record the packet information like IP address, port address, ACK, SEQ number and so on while they pass through the router, and the router checks every incoming packet to detect if this packet is valid.

**Discard Ping from WAN** makes any host on the WAN side can't ping this router. And finally, "Remote Administrator Hosts" enables you to perform administration task from a remote host. If this feature is enabled, only specified IP address(-es) can perform remote administration.

**Enable SPI Scenario**

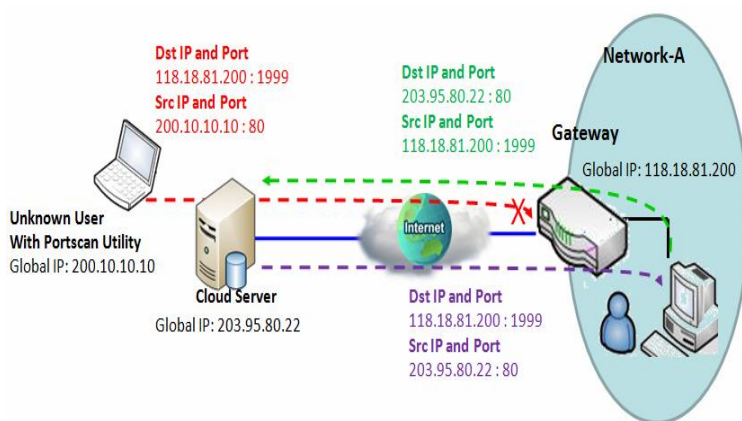

As shown in the diagram, Gateway has the IP address of 118.18.81.200 for WAN interface and 192.168.1.253 for LAN interface. It serves as a NAT gateway. Users in Network-A initiate to access cloud server through the gateway. Sometimes, unknown users will simulate the packets but use different source IP to masquerade. With the SPI feature been enabled at the gateway, it will block such packets from unknown users.

**Discard Ping from WAN & Remote Administrator Hosts Scenario**

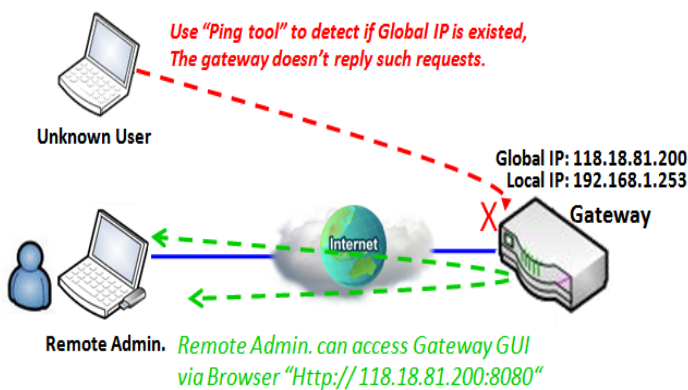

"Discard Ping from WAN" makes any host on the WAN side can't ping this gateway reply any ICMP packets. Enable the Discard Ping from WAN function to prevent security leak when local users surf the internet.

Remote administrator knows the gateway's global IP, and he can access the Gateway GUI via TCP port 8080.

## Firewall Options Setting

Go to **Security > Firewall > Options** Tab.

The firewall options setting allows network administrator to modify the behavior of the firewall and to enable Remote Router Access Control.

### Enable Firewall Options

| Firewall Options [ Help ] |  |
|---------------------------|--|
| Item                      | Setting                                    |
| ▶ Stealth Mode            | <input type="checkbox"/> Enable            |
| ▶ SPI                     | <input checked="" type="checkbox"/> Enable |
| ▶ Discard Ping from WAN   | <input type="checkbox"/> Enable            |

| Firewall Options      |                                 |  |
|-----------------------|---------------------------------|--|
| Item                  | Value setting                   | Description  |
| Stealth Mode          | The box is unchecked by default | Check the <b>Enable</b> box to activate the Stealth Mode function          |
| SPI                   | The box is checked by default   | Check the <b>Enable</b> box to activate the SPI function                   |
| Discard Ping from WAN | The box is unchecked by default | Check the <b>Enable</b> box to activate the Discard Ping from WAN function |

### Define Remote Administrator Host

The router allows network administrator to manage router remotely. The network administrator can assign specific IP address and service port to allow accessing the router.

| Remote Administrator Host Definition |           |          |        |             |              |                          |        |
|--------------------------------------|-----------|----------|--------|-------------|--------------|--------------------------|--------|
| ID                                   | Interface | Protocol | IP     | Subnet Mask | Service Port | Enable                   | Action |
| 1                                    | All WAN   | HTTP     | Any IP | N/A         | 80           | <input type="checkbox"/> | Edit   |
| 2                                    | All WAN   | HTTP     | Any IP | N/A         | 80           | <input type="checkbox"/> | Edit   |
| 3                                    | All WAN   | HTTP     | Any IP | N/A         | 80           | <input type="checkbox"/> | Edit   |
| 4                                    | All WAN   | HTTP     | Any IP | N/A         | 80           | <input type="checkbox"/> | Edit   |
| 5                                    | All WAN   | HTTP     | Any IP | N/A         | 80           | <input type="checkbox"/> | Edit   |

## Remote Administrator Host Definition

| Item                     | Value setting  | Description  |
|--------------------------|--|--|
| <b>Protocol</b>          | HTTP is set by default                                   | Select <b>HTTP</b> or <b>HTTPS</b> method for router access.   |
| <b>IP</b>                | A Must filled setting                                    | This field is to specify the remote host to assign access right for remote access.<br>Select <b>Any IP</b> to allow any remote hosts<br>Select <b>Specific IP</b> to allow the remote host coming from a specific subnet. An IP address entered in this field and a selected <b>Subnet Mask</b> to compose the subnet. |
| <b>Service Port</b>      | 1. 80 for HTTP by default<br>2. 443 for HTTPS by default | This field is to specify a Service Port to HTTP or HTTPS connection.<br><b>Value Range: 1 ~ 65535.</b>   |
| <b>Enabling the rule</b> | The box is unchecked by default.                         | Click <b>Enable</b> box to activate this rule.   |
| <b>Save</b>              | N/A  | Click <b>Enable</b> box to activate this rule then save the settings.  |
| <b>Undo</b>              | N/A  | Click <b>Undo</b> to cancel the settings   |

## 5. Administration

### 5.1 Configure & Manage

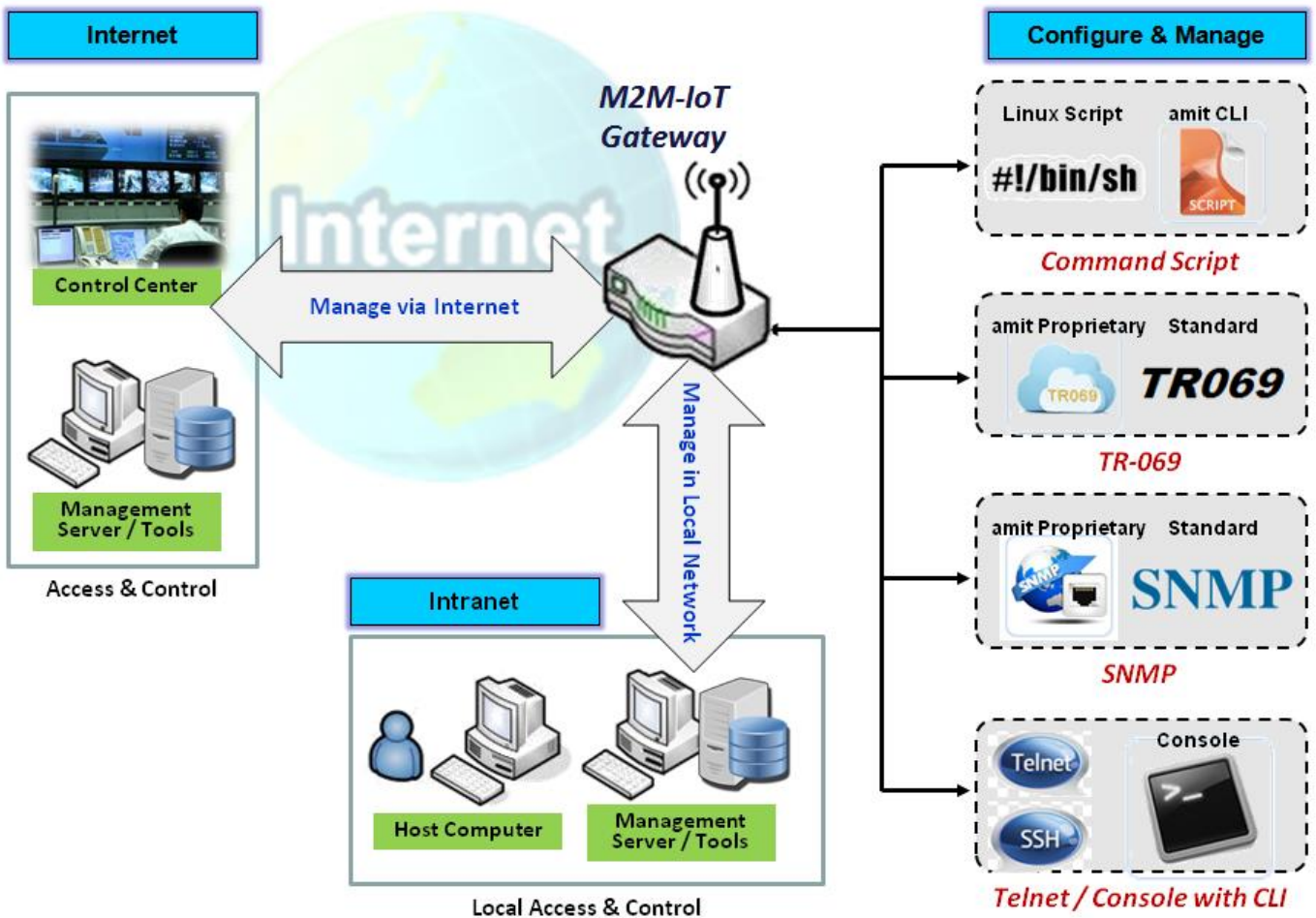

Configure & Manage refers to enterprise-wide administration of distributed systems including (and commonly in practice) computer systems. Centralized management has a time and effort trade-off that is related to the size of the company, the expertise of the IT staff, and the amount of technology being used. This device supports many system management protocols, such as Command Script, TR-069, SNMP, and Telnet with CLI. You can setup those configurations in the "Configure & Manage" section.



### 5.1.1 Command Script

Command script configuration is the application that allows administrator to setup the pre-defined configuration in plain text style and apply configuration on startup.

Go to **Administration > Configure & Manage > Command Script** Tab.

#### Enable Command Script Configuration

| Configuration    |  |
|------------------|--|
| Item             | Setting  |
| ▶ Command Script | <input checked="" type="checkbox"/> Enable   |
| ▶ Backup Script  | <input type="button" value="Via Web UI"/>  |
| ▶ Upload Script  | <input type="button" value="Via Web UI"/>  |
| ▶ Script Name    | <input type="text" value="6.txt"/>   |
| ▶ Version        | <input type="text" value="6"/>   |
| ▶ Description    | <div style="border: 1px solid #ccc; padding: 5px; min-height: 40px;">popis 6</div> |
| ▶ Update time    | 2018-09-17T12:25:51  |

| Configuration |  |   |
|---------------|--|---|
| Item          | Value setting                                  | Description   |
| Configuration | The box is unchecked by default                | Check the <b>Enable</b> box to activate the Command Script function.  |
| Backup Script | N/A  | Click the <b>Via Web UI</b> button to backup the existed command script in a .txt file. You can specify the script file name in <b>Script Name</b> below. |
| Upload Script | N/A  | Click the <b>Via Web UI</b> button to Upload the existed command script from a specified .txt file.   |
| Script Name   | 1.An Optional setting<br>2.Any valid file name | Specify a script file name for script backup, or display the selected upload script file name.<br><b>Value Range:</b> 0 ~ 32 characters.                  |
| Version       | 1.An Optional setting<br>2.Any string          | Specify the version number for the applied Command script.<br><b>Value Range:</b> 0 ~ 32 characters.  |
| Description   | 1.An Optional setting<br>2.Any string          | Enter a short description for the applied Command script.   |
| Update time   | N/A  | It records the upload time for last command script upload.  |

#### Edit Plain Text Command Script Configuration

You can edit the plain text configuration settings in the Command Script Editor window as shown below.

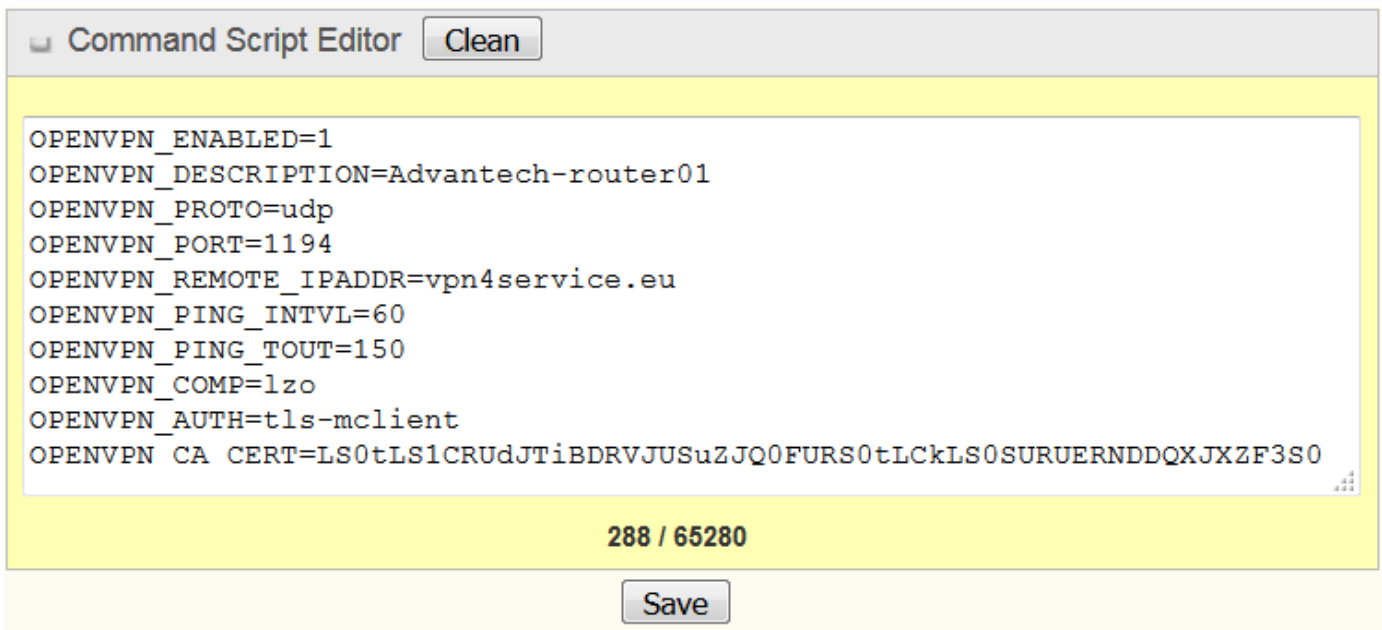

### Plain Text Configuration

| Item  | Value setting | Description  |
|-------|---------------|--|
| Clean | NA            | Clean text area. (You should click <b>Save</b> button to further clean the configuration already saved in the system.) |
| Save  | NA            | Save configuration   |

The supported plain text configuration items are shown in the following list. For the settings that can be executed with standard Linux commands, you can put them in a script file, and apply to the system configure with **STARTUP** command. For those configurations without corresponding Linux command set to configure, you can configure them with proprietary command set.

### Configuration Content

| Key                   | Value setting             | Description  |
|-----------------------|---------------------------|--|
| OPENVPN_ENABLED       | 1 : enable<br>0 : disable | Enable or disable OpenVPN Client function.   |
| OPENVPN_DESCRIPTION   | A Must filled Setting     | Specify the tunnel name for the OpenVPN Client connection.   |
| OPENVPN_PROTO         | udp<br>tcp                | Define the <b>Protocol</b> for the OpenVPN Client. <ul style="list-style-type: none"> <li>Select <b>TCP</b> or <b>TCP /UDP</b><br/>-&gt;The OpenVPN will use TCP protocol, and <b>Port</b> will be set as 443 automatically.</li> <li>Select <b>UDP</b><br/>-&gt; The OpenVPN will use UDP protocol, and <b>Port</b> will be set as 1194 automatically.</li> </ul> |
| OPENVPN_PORT          | A Must filled Setting     | Specify the <b>Port</b> for the OpenVPN Client to use.   |
| OPENVPN_REMOTE_IPADDR | IP or FQDN                | Specify the <b>Remote IP/FQDN</b> of the peer OpenVPN Server for this OpenVPN Client tunnel.<br>Fill in the IP address or FQDN.  |
| OPENVPN_PING_INTVL    | seconds                   | Specify the time interval for OpenVPN keep-alive checking.   |

|                           |                                 |  |
|---------------------------|---------------------------------|--|
| <b>OPENVPN_PING_TOUT</b>  | seconds                         | Specify the timeout value for OpenVPN Client keep-alive checking.  |
| <b>OPENVPN_COMP</b>       | Adaptive                        | Specify the <b>LZO Compression</b> algorithm for OpenVPN client.   |
| <b>OPENVPN_AUTH</b>       | Static Key/TLS                  | Specify the authorization mode for the OpenVPN tunnel.<br><ul style="list-style-type: none"> <li>• <b>TLS</b><br/>-&gt;The OpenVPN will use TLS authorization mode, and the following items <b>CA Cert.</b>, <b>Client Cert.</b> and <b>Client Key</b> need to specify as well.</li> </ul> |
| <b>OPENVPN_CA_CERT</b>    | A Must filled Setting           | Specify the Trusted CA certificate for the OpenVPN client. It will go through Base64 Conversion.   |
| <b>OPENVPN_LOCAL_CERT</b> | A Must filled Setting           | Specify the local certificate for OpenVPN client. It will go through Base64 Conversion.  |
| <b>OPENVPN_LOCAL_KEY</b>  | A Must filled Setting           | Specify the local key for the OpenVPN client. It will go through Base64 Conversion.  |
| <b>OPENVPN_EXTRA_OPTS</b> | Options                         | Specify the extra options setting for the OpenVPN client.  |
| <b>IP_ADDR1</b>           | IP                              | Ethernet LAN IP  |
| <b>IP_NETM1</b>           | Net mask                        | Ethernet LAN MASK  |
| <b>PPP_MONITORING</b>     | 1 : enable<br>0 : disable       | When the Network Monitoring feature is enabled, the router will use DNS Query or ICMP to periodically check Internet connection – connected or disconnected.   |
| <b>PPP_PING</b>           | 0 : DNS Query<br>1 : ICMP Query | With <b>DNS Query</b> , the system checks the connection by sending DNS Query packets to the destination specified in PPP_PING_IPADDR.<br>With <b>ICMP Query</b> , the system will check connection by sending ICMP request packets to the destination specified in PPP_PING_IPADDR.       |
| <b>PPP_PING_IPADDR</b>    | IP                              | Specify an IP address as the target for sending DNS query/ICMP request.  |
| <b>PPP_PING_INTVL</b>     | seconds                         | Specify the time interval for between two DNS Query or ICMP checking packets.  |
| <b>STARTUP</b>            | Script file                     | For the configurations that can be configured with standard Linux commands, you can put them in a script file, and apply the script file with STARTUP command.<br>For example,<br>STARTUP=#!/bin/sh<br>STARTUP=echo "startup done" > /tmp/demo   |

## Plain Text System Configuration with Telnet

In addition to the web-style plain text configuration as mentioned above, the router system also allow the configuration via Telnet CLI. Administrator can use the proprietary telnet command “**txtConfig**” and related action items to perform the plain system configuration.

The command format is: `txtConfig (action) [option]`

| Action                 | Option             | Description  |
|------------------------|--------------------|--|
| <b>clone</b>           | <i>Output file</i> | Duplicate the configuration content from database and stored as a configuration file.<br>(ex: <code>txtConfig clone /tmp/config</code> )<br>The contents in the configuration file are the same as the plain text commands mentioned above. This action is exactly the same as performing the “Backup” plain text configuration. |
| <b>commit</b>          | an existing file   | Commit the configuration content to database.<br>(ex: <code>txtConfig commit /tmp/config</code> )  |
| <b>enable</b>          | NA                 | Enable plain text system config.<br>(ex: <code>txtConfig enable</code> )   |
| <b>disable</b>         | NA                 | Disable plain text system config.<br>(ex: <code>txtConfig disable</code> )   |
| <b>run_immediately</b> | NA                 | Apply the configuration content that has been committed in database.<br>(ex: <code>txtConfig run_immediately</code> )  |
| <b>run_immediately</b> | an existing file   | Assign a configuration file to apply.<br>(ex: <code>txtConfig run_immediately /tmp/config</code> )   |

5.1.2 TR-069

TR-069 (Technical Report 069) is a Broadband Forum technical specification entitled CPE WAN Management Protocol (CWMP). It defines an application layer protocol for remote management of end-user devices, like this router device. As a bidirectional SOAP/HTTP-based protocol, it provides the communication between customer-premises equipment (CPE) and Auto Configuration Servers (ACS). The Security Gateway is such CPE.

TR-069 is a customized feature for ISP. It is not recommend that you change the configuration for this. If you have any problem in using this feature for device management, please contact with your ISP or the ACS provider for help. At the right upper corner of TR-069 Setting screen, one “[Help]” command let you see the same message about that.

**Scenario - Managing deployed gateways through an ACS Server**

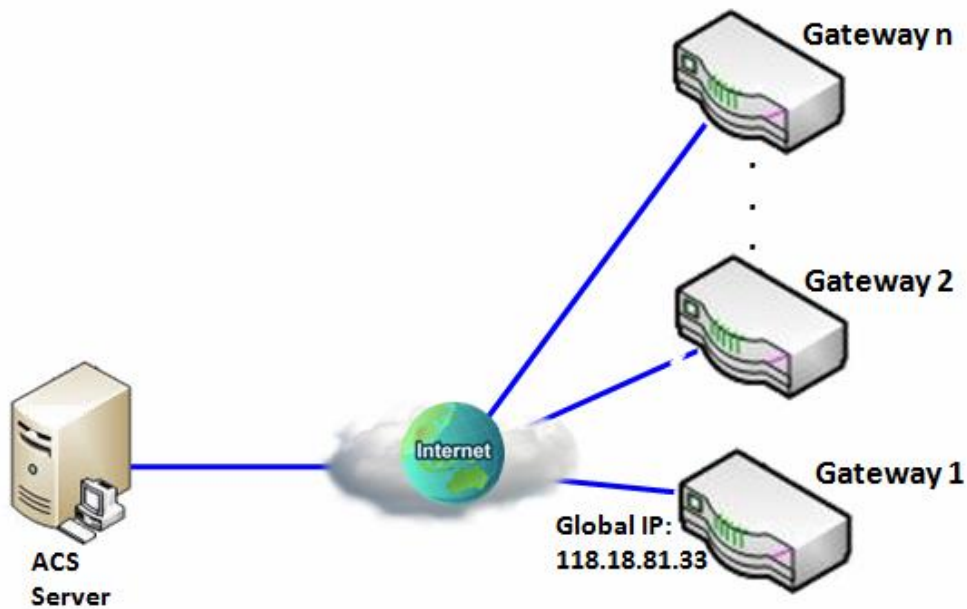

**Scenario Application Timing**

- When the enterprise data center wants to use an ACS server to manage remote gateways geographically distributed elsewhere in the world, the gateways in all branch offices must have an embedded TR-069 agent to communicate with the ACS server.
- So that the ACS server can configure, FW upgrade and monitor these gateways and their corresponding Intranets.

**Scenario Description**

- The ACS server can configure, upgrade with latest FW and monitor these gateways.
- Remote gateways inquire the ACS server for jobs to do in each time period.
- The ACS server can ask the gateways to execute some urgent jobs.
- Parameter Setup Example
- Following tables list the parameter configuration as an example for the Gateway 1 in above diagram

with "TR-069" enabling.

- Use default value for those parameters that are not mentioned in the tables.

| Configuration Path          | [TR-069]-[Configuration]  |
|-----------------------------|---|
| TR-069                      | ■ <i>Enable</i>   |
| ACS URL                     | <a href="http://qa.acslite.com/cpe.php">http://qa.acslite.com/cpe.php</a> |
| ACS User Name               | <i>ACSUserName</i>  |
| ACS Password                | <i>ACSPassword</i>  |
| ConnectionRequest Port      | <i>8099</i>   |
| ConnectionRequest User Name | <i>ConnReqUserName</i>  |
| ConnectionRequest Password  | <i>ConnReqPassword</i>  |
| Inform                      | ■ <i>Enable Interval 900</i>  |

**Scenario Operation Procedure**

- In above diagram, the ACS server can manage multiple gateways in the Internet. The "Gateway 1" is one of them and has 118.18.81.33 IP address for its WAN-1 interface.
- When all remote gateways have booted up, they will try to connect to the ACS server.
- Once the connections are established successfully, the ACS server can configure, upgrade with latest FW and monitor these gateways.
- Remote gateways inquire the ACS server for jobs to do in each time period.
- If the ACS server needs some urgent jobs to be done by the gateways, it will issue the "Connection Request" command to those gateways. And those gateways make immediate connections in response to the ACS server's immediate connection request for executing the urgent jobs.

**TR-069 Setting**

Go to **Administration > Configure & Manage > TR-069** tab.

In "TR-069" page, there is only one configuration window for TR-069 function. In the window, you must specify the related information for your security router to connect to the ACS. Drive the function to work by specifying the URL of the ACS server, the account information to login the ACS server, the service port and the account information for connection requesting from the ACS server, and the time interval for job inquiry. Except the inquiry time, there are no activities between the ACS server and the routers until the next inquiry cycle. But if the ACS server has new jobs that are expected to do by the routers urgently, it will ask these routers by using connection request related information for immediate connection for inquiring jobs and executing.

**Enable TR-069**

| Configuration <span style="float: right;">[ Help ]</span> |   |
|---|---|
| Item  | Setting   |
| ▶ TR-069  | <input type="checkbox"/> Enable   |
| ▶ Interface   | WAN-1 ▾   |
| ▶ Data model  | ACS Cloud Data Model ▾  |
| ▶ ACS URL   | <input type="text"/>  |
| ▶ ACS UserName  | <input type="text"/>  |
| ▶ ACS Password  | <input type="text"/>  |
| ▶ Connection Request Port                                 | 8099  |
| ▶ Connection Request UserName                             | <input type="text"/>  |
| ▶ Connection Request Password                             | <input type="text"/>  |
| ▶ Inform  | <input checked="" type="checkbox"/> Enable Interval <input type="text" value="300"/>  |
| ▶ Certification Setup                                     | <input checked="" type="radio"/> default<br><input type="radio"/> Select from Certificate List<br>Certificate: <input type="text"/> ▾ |

| TR-069                     |  |   |
|----------------------------|--|---|
| Item                       | Value setting  | Description   |
| TR-069                     | The box is unchecked by default  | Check the <b>Enable</b> box to activate TR-069 function.  |
| Interface                  | <b>WAN-1</b> is selected by default.   | When you finish set basic network WAN-1 ~ WAN-n, you can choose WAN-1 ~ WAN-n<br>When you finish set Security > VPN > IPSec/OpenVPN/PPTP/L2TP/GRE, you can choose IPSec/OpenVPN/PPTP/L2TP/GRE tunnel, the interface just like "IPSec #1"  |
| Data Model                 | <b>ACS Cloud Data Model</b> is selected by default.                                  | Select the TR-069 data model for the remote management.<br><b>Standard:</b> the ACS Server is a standard one, which is fully comply with TR-069.<br><b>ACS Cloud Data Model:</b> Select this data model if you intend to use Cloud ACS Server to managing the deployed routers. |
| ACS URL                    | A Must filled setting  | You can ask ACS manager provide ACS URL and manually set  |
| ACS Username               | A Must filled setting  | You can ask ACS manager provide ACS username and manually set   |
| ACS Password               | A Must filled setting  | You can ask ACS manager provide ACS password and manually set   |
| ConnectionRequest Port     | 1. A Must filled setting.<br>2. <b>By default 8099 is set.</b>                       | You can ask ACS manager provide ACS ConnectionRequest Port and manually set<br><i>Value Range:</i> 0 ~ 65535.   |
| ConnectionRequest UserName | A Must filled setting  | You can ask ACS manager provide ACS ConnectionRequest Username and manually set   |
| ConnectionRequest Password | A Must filled setting  | You can ask ACS manager provide ACS ConnectionRequest Password and manually set   |
| Inform                     | 1. The box is checked by default.<br>2. <b>The Interval value is 300 by default.</b> | When the <b>Enable</b> box is checked, the router (CPE) will periodically send inform message to ACS Server according to the <b>Interval</b> setting.<br><i>Value Range:</i> 0 ~ 86400 for Inform Interval.   |
| Certification Setup        | The <b>default</b> box is selected by default  | You can leave it as <b>default</b> or select an expected certificate and key from the drop down list.<br>Refer to <b>Object Definition &gt; Certificate</b> Section for the Certificate configuration.  |
| Save                       | N/A  | Click <b>Save</b> to save the settings.   |
| Undo                       | N/A  | Click <b>Undo</b> to cancel the modifications.  |

When you finish set **ACS URL ACS Username ACS Password**, your router (CPE, Client Premium Equipment) can send inform to ACS Server.

When you finish set **ConnectionRequest Port ConnectionRequest Username ConnectionRequest Password**, ACS Server can ask the gateway (CPE) to send inform to ACS Server.



## Enable STUN Server

| STUN Settings [ Help ] |   |
|------------------------|---|
| Item                   | Setting   |
| ▶ STUN                 | <input checked="" type="checkbox"/> Enable        |
| ▶ Server Address       | <input type="text"/>                              |
| ▶ Server Port          | <input type="text" value="3478"/> (1~65535)       |
| ▶ Keep Alive Period    | <input type="text" value="0"/> (0~65535)second(s) |

### STUN Settings Configuration

| Item              | Value setting  | Description   |
|-------------------|--|---|
| STUN              | The box is checked by default                                    | Check the <b>Enable</b> box to activate STUN function.  |
| Server Address    | 1. String format: any IPv4 address<br>2. It is an optional item. | Specify the IP address for the expected STUN Server.  |
| Server Port       | 1. An optional setting<br>2. <b>3478</b> is set by default       | Specify the port number for the expected STUN Server.<br><i>Value Range:</i> 1 ~ 65535.                   |
| Keep Alive Period | 1. An optional setting<br>2. <b>0</b> is set by default          | Specify the keep alive time period for the connection with STUN Server.<br><i>Value Range:</i> 0 ~ 65535. |
| Save              | N/A  | Click <b>Save</b> to save the settings.   |
| Undo              | N/A  | Click <b>Undo</b> to cancel the modifications.  |

### 5.1.3 SNMP

In brief, SNMP, the Simple Network Management Protocol, is a protocol designed to give a user the capability to remotely manage a computer network by polling and setting terminal values and monitoring network events.

In typical SNMP uses, one or more administrative computers, called managers, have the task of monitoring or managing a group of hosts or devices on a computer network. Each managed system executes, at all times, a software component called an agent which reports information via SNMP to the manager.

SNMP agents expose management data on the managed systems as variables. The protocol also permits active management tasks, such as modifying and applying a new configuration through remote modification of these variables. The variables accessible via SNMP are organized in hierarchies. These hierarchies, and other metadata (such as type and description of the variable), are described by Management Information Bases (MIBs).

The device supports several public MIBs and one private MIB for the SNMP agent. The supported MIBs are as follow: MIB-II (RFC 1213, Include IPv6), IF-MIB, IP-MIB, TCP-MIB, UDP-MIB, SMIV1 and SMIV2, SNMPv2-TM and SNMPv2-MIB, and AMIB (a Proprietary MIB)

### SNMP Management Scenario

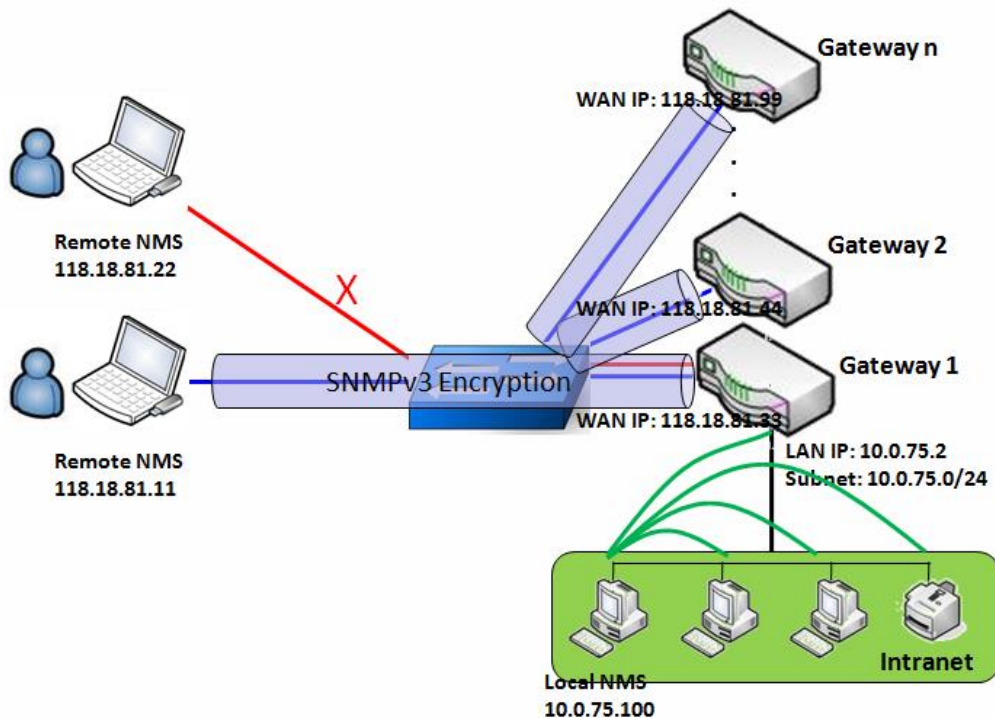

### Scenario Application Timing

- There are two application scenarios of SNMP Network Management Systems (NMS).
- Local NMS is in the Intranet and manage all devices that support SNMP protocol in the Intranet. Another one is the Remote NMS to manage some devices whose WAN interfaces are connected together by

using a switch or a router with UDP forwarding.

- If you want to manage some devices and they all have supported SNMP protocol, use either one application scenario, especially the management of devices in the Intranet.
- In managing devices in the Internet, the TR-069 is the better solution. Please refer to last sub-section.

### Scenario Description

- The NMS server can monitor and configure the managed devices by using SNMP protocol, and those devices are located at where UDP packets can reach from NMS.
- The managed devices report urgent trap events to the NMS servers.
- Use SNMPv3 version of protocol can protected the transmitting of SNMP commands and responses.
- The remote NMS with privilege IP address can manage the devices, but other remote NMS can't.

### Parameter Setup Example

- Following tables list the parameter configuration as an example for the Gateway 1 in above diagram with "SNMP" enabling at LAN and WAN interfaces.
- Use default value for those parameters that are not mentioned in the tables.

| Configuration Path    | [SNMP]-[Configuration]         |
|-----------------------|--------------------------------|
| SNMP Enable           | ■ LAN ■ WAN                    |
| Supported Versions    | ■ v1 ■ v2c ■ v3                |
| Get / Set Community   | ReadCommunity / WriteCommunity |
| Trap Event Receiver 1 | 118.18.81.11                   |
| WAN Access IP Address | 118.18.81.11                   |

| Configuration Path | [SNMP]-[User Privacy Definition] |            |              |
|--------------------|----------------------------------|------------|--------------|
| ID                 | 1                                | 2          | 3            |
| User Name          | UserName1                        | UserName2  | UserName3    |
| Password           | Password1                        | Password2  | Disable      |
| Authentication     | MD5                              | SHA-1      | Disable      |
| Encryption         | DES                              | Disable    | Disable      |
| Privacy Mode       | authPriv                         | authNoPriv | noAuthNoPriv |
| Privacy Key        | 12345678                         | Disable    | Disable      |
| Authority          | Read/Write                       | Read       | Read         |
| Enable             | ■ Enable                         | ■ Enable   | ■ Enable     |

### Scenario Operation Procedure

- In above diagram, the NMS server can manage multiple devices in the Intranet or a UDP-reachable network. The "Gateway 1" is one of the managed devices, and it has the IP address of 10.0.75.2 for LAN interface and 118.18.81.33 for WAN-1 interface. It serves as a NAT router.
- At first stage, the NMS manager prepares related information for all managed devices and records them in the NMS system. Then NMS system gets the status of all managed devices by using SNMP get commands.
- When the manager wants to configure the managed devices, the NMS system allows him to do that by using SNMP set commands. The "UserName1" account is used if the manager uses SNMPv3 protocol

for configuring the "Gateway 1". Only the "UserName1" account can let the "Gateway 1" accept the configuration from the NMS since the authority of the account is "Read/Write".

- Once a managed device has an urgent event to send, the device will issue a trap to the Trap Event Receivers. The NMS itself could be one among them.
- If you want to secure the transmitted SNMP commands and responses between the NMS and the managed devices, use SNMPv3 version of protocol.
- The remote NMS without privilege IP address can't manage the "Gateway 1", since "Gateway 1" allows only the NMS with privilege IP address can manage it via its WAN interface.

### SNMP Setting

Go to **Administration > Configure & Manage > SNMP** tab.

The SNMP allows user to configure SNMP relevant setting which includes interface, version, access control and trap receiver.

#### Enable SNMP

| Configuration        |  |
|----------------------|--|
| Item                 | Setting  |
| ▶ SNMP Enable        | <input type="checkbox"/> LAN <input type="checkbox"/> WAN                            |
| ▶ WAN Interface      | All WANs ▾   |
| ▶ Supported Versions | <input type="checkbox"/> v1 <input type="checkbox"/> v2c <input type="checkbox"/> v3 |
| ▶ Remote Access IP   | Specific IP Address ▾ <input type="text"/> (IP Address/FQDN)                         |
| ▶ SNMP Port          | 161 <input type="text"/>   |
| ▶ Trap Period        | 10 <input type="text"/> (1~1440 minutes)   |

| SNMP          |  |  |
|---------------|--|--|
| Item          | Value setting  | Description  |
| SNMP Enable   | 1.The boxes are unchecked by default                                 | Select the interface for the SNMP and enable SNMP functions.<br>When Check the <b>LAN</b> box, it will activate SNMP functions and you can access SNMP from LAN side;<br>When Check the <b>WAN</b> box, it will activate SNMP functions and you can access SNMP from WAN side. |
| WAN Interface | 1.A Must filled setting<br>2. <b>ALL WANs is selected by default</b> | Specify the WAN interface that a remote SNMP host can access to the device.<br>By default, <b>All WANs</b> is selected, and there is no limitation for the WAN interface.  |

|                           |  |   |
|---------------------------|--|---|
| <b>Supported Versions</b> | <ol style="list-style-type: none"> <li>1. A Must filled setting</li> <li>2. The boxes are unchecked by default</li> </ol>  | <p>Select the version for the SNMP</p> <p>When Check the <b>v1</b> box.<br/>It means you can access SNMP by version 1.</p> <p>When Check the <b>v2c</b> box.<br/>It means you can access SNMP by version 2c.</p> <p>When Check the <b>v3</b> box.<br/>It means you can access SNMP by version 3.</p>  |
| <b>Remote Access IP</b>   | <ol style="list-style-type: none"> <li>1. String format: any IPv4 address</li> <li>2. It is an optional item.</li> </ol>   | <p>Specify the <b>Remote Access IP</b> for WAN.</p> <p>Select <b>Specific IP Address</b>, and fill in a certain IP address. It means only this IP address can access SNMP from LAN/WAN side.</p> <p>Select <b>IP Range</b>, and fill in a range of IP addresses. It means the IP address within specified range can access SNMP from LAN/WAN side.</p> <p>If you left it as blank, it means any IP address can access SNMP from WAN side.</p> |
| <b>SNMP Port</b>          | <ol style="list-style-type: none"> <li>1. String format: any port number</li> <li>2. The default SNMP port is <b>161</b>.</li> <li>3. A Must filled setting</li> </ol> | <p>Specify the <b>SNMP Port</b>.</p> <p>You can fill in any port number. But you must ensure the port number is not to be used.</p> <p><i>Value Range: 1 ~ 65535.</i></p>   |
| <b>Trap Period</b>        | <ol style="list-style-type: none"> <li>1. A Must filled setting</li> <li>2. The default Trap Period is 10 minutes</li> </ol>   | <p>Specify the <b>Trap Period</b> in minutes.</p> <p><i>Value Range: 1 ~ 1440.</i></p>  |
| <b>Save</b>               | N/A  | Click <b>Save</b> to save the settings  |
| <b>Undo</b>               | N/A  | Click <b>Undo</b> to cancel the settings  |

## Create/Edit Multiple Community

The SNMP allows you to custom your access control for version 1 and version 2 user. The router supports up to a maximum of 10 community sets.

| <input type="checkbox"/> Multiple Community List <input type="button" value="Add"/> <input type="button" value="Delete"/> |           |        |         |
|---|-----------|--------|---------|
| ID  | Community | Enable | Actions |

When **Add** button is applied, **Multiple Community Rule Configuration** screen will appear.

Multiple Community Rule Configuration

| Item        | Setting                                    |
|-------------|--|
| ▶ Community | Read Only ▾ <input type="text"/>           |
| ▶ Enable    | <input checked="" type="checkbox"/> Enable |

| Multiple Community Rule Configuration |   |   |
|---------------------------------------|---|---|
| Item                                  | Value setting   | Description   |
| Community                             | 1. Read Only is selected by default<br>2. A Must filled setting<br>3. String format: any text | Specify this version 1 or version v2c user’s community that will be allowed Read Only (GET and GETNEXT) or Read-Write (GET, GETNEXT and SET) access respectively.<br>The maximum length of the community is 32.                               |
| Enable                                | 1.The box is checked by default   | Click Enable to enable this version 1 or version v2c user.  |
| Save                                  | N/A   | Click the <b>Save</b> button to save the configuration. But it does not apply to SNMP functions. When you return to the SNMP main page. It will show “Click on save button to apply your changes” remind user to click main page Save button. |
| Undo                                  | N/A   | Click the <b>Undo</b> button to cancel the settings.  |
| Back                                  | N/A   | Click the <b>Back</b> button to return to last page.  |

**Create/Edit User Privacy**

The SNMP allows you to custom your access control for version 3 user. The router supports up to a maximum of 128 User Privacy sets.

User Privacy List

| ID | User Name | Password | Authentication | Encryption | Privacy Mode | Privacy Key | Authority | OID Filter Prefix | Enable | Actions |
|----|-----------|----------|----------------|------------|--------------|-------------|-----------|-------------------|--------|---------|
|----|-----------|----------|----------------|------------|--------------|-------------|-----------|-------------------|--------|---------|

When **Add** button is applied, **User Privacy Rule Configuration** screen will appear.

| User Privacy Rule Configuration |  |
|---------------------------------|--|
| Item                            | Setting                                    |
| ▶ User Name                     | <input type="text"/>                       |
| ▶ Password                      | <input type="password"/>                   |
| ▶ Authentication                | None ▾                                     |
| ▶ Encryption                    | None ▾                                     |
| ▶ Privacy Mode                  | noAuthNoPriv ▾                             |
| ▶ Privacy Key                   | <input type="password"/>                   |
| ▶ Authority                     | Read ▾                                     |
| ▶ OID Filter Prefix             | 1 <input type="text"/>                     |
| ▶ Enable                        | <input checked="" type="checkbox"/> Enable |

| User Privacy Rule Configuration |  |   |
|---------------------------------|--|---|
| Item                            | Value setting  | Description   |
| User Name                       | 1. A Must filled setting<br>2. String format: any text | Specify the <b>User Name</b> for this version 3 user.<br><b>Value Range: 1 ~ 32 characters.</b>   |
| Password                        | 1. String format: any text                             | When your <b>Privacy Mode</b> is <b>authNoPriv</b> or <b>authPriv</b> , you must specify the <b>Password</b> for this version 3 user.<br><b>Value Range: 8 ~ 64 characters.</b>   |
| Authentication                  | 1. <b>None</b> is selected by default                  | When your <b>Privacy Mode</b> is <b>authNoPriv</b> or <b>authPriv</b> , you must specify the <b>Authentication</b> types for this version 3 user.<br>Selected the authentication types <b>MD5/ SHA-1</b> to use.  |
| Encryption                      | 1. <b>None</b> is selected by default                  | When your <b>Privacy Mode</b> is <b>authPriv</b> , you must specify the <b>Encryption</b> protocols for this version 3 user.<br>Selected the encryption protocols <b>DES / AES</b> to use.  |
| Privacy Mode                    | 1. <b>noAuthNoPriv</b> is selected by default          | Specify the <b>Privacy Mode</b> for this version 3 user.<br>Selected the <b>noAuthNoPriv</b> .<br>You do not use any authentication types and encryption protocols.<br>Selected the <b>authNoPriv</b> .<br>You must specify the <b>Authentication</b> and <b>Password</b> .<br>Selected the <b>authPriv</b> .<br>You must specify the Authentication, Password, Encryption and Privacy Key. |
| Privacy Key                     | 1. String format: any text                             | When your <b>Privacy Mode</b> is <b>authPriv</b> , you must specify the <b>Privacy Key (8 ~ 64 characters)</b> for this version 3 user.   |
| Authority                       | 1. <b>Read</b> is selected by default                  | Specify this version 3 user's <b>Authority</b> that will be allowed <b>Read Only</b> (GET and GETNEXT) or <b>Read-Write</b> (GET, GETNEXT and SET) access respectively.   |

|                          |  |  |
|--------------------------|--|--|
| <b>OID Filter Prefix</b> | 1. The default value is 1<br>2. A Must filled setting<br>3. String format: any legal OID | The <b>OID Filter Prefix</b> restricts access for this version 3 user to the sub-tree rooted at the given OID.<br><b>Value Range: 1 ~2080768.</b>  |
| <b>Enable</b>            | 1.The box is checked by default  | Click <b>Enable</b> to enable this version 3 user.   |
| <b>Save</b>              | N/A  | Click the <b>Save</b> button to save the configuration. But it does not apply to SNMP functions. When you return to the SNMP main page. It will show “Click on save button to apply your changes” remind user to click main page <b>Save</b> button. |
| <b>Undo</b>              | N/A  | Click the <b>Undo</b> button to cancel the settings  |
| <b>Back</b>              | N/A  | Click the <b>Back</b> button to return the last page.  |

## Create/Edit Trap Event Receiver

The SNMP allows you to custom your trap event receiver. The router supports up to a maximum of 4 Trap Event Receiver sets.

| <input type="checkbox"/> Trap Event Receiver List <input type="button" value="Add"/> <input type="button" value="Delete"/> |           |             |              |                |           |          |              |                |            |             |        |         |
|--|-----------|-------------|--------------|----------------|-----------|----------|--------------|----------------|------------|-------------|--------|---------|
| ID   | Server IP | Server Port | SNMP Version | Community Name | User Name | Password | Privacy Mode | Authentication | Encryption | Privacy Key | Enable | Actions |

When **Add** button is applied, **Trap Event Receiver Rule Configuration** screen will appear. The default SNMP Version is v1. The configuration screen will provide the version 1 must filled items.

| <input type="checkbox"/> Trap Event Receiver Rule Configuration |  |
|---|--|
| Item  | Setting                                    |
| ▶ Server IP   | <input type="text"/> (IP Address/FQDN)     |
| ▶ Server Port   | <input type="text" value="162"/>           |
| ▶ SNMP Version  | <input type="text" value="v1"/> ▼          |
| ▶ Community Name  | <input type="text"/>                       |
| ▶ Enable  | <input checked="" type="checkbox"/> Enable |

When you selected v2c, the configuration screen is exactly the same as that of v1, except the version. When you selected v3, the configuration screen will provide more setting items for the version 3 Trap.



Trap Event Receiver Rule Configuration

| Item             | Setting                                    |
|------------------|--|
| ▶ Server IP      | <input type="text"/> (IP Address/FQDN)     |
| ▶ Server Port    | <input type="text" value="162"/>           |
| ▶ SNMP Version   | <input type="text" value="v3"/>            |
| ▶ Community Name | <input type="text"/>                       |
| ▶ User Name      | <input type="text"/>                       |
| ▶ Password       | <input type="text"/>                       |
| ▶ Privacy Mode   | <input type="text" value="noAuthNoPriv"/>  |
| ▶ Authentication | <input type="text" value="None"/>          |
| ▶ Encryption     | <input type="text" value="None"/>          |
| ▶ Privacy Key    | <input type="text"/>                       |
| ▶ Enable         | <input checked="" type="checkbox"/> Enable |

| Trap Event Receiver Rule Configuration |   |   |
|--|---|---|
| Item                                   | Value setting   | Description   |
| Server IP                              | <ol style="list-style-type: none"> <li>1. A Must filled setting</li> <li>2. String format: any IPv4 address or FQDN</li> </ol>                                      | <p>Specify the trap <b>Server IP</b> or <b>FQDN</b>.<br/>The DUT will send trap to the server IP/FQDN.</p>  |
| Server Port                            | <ol style="list-style-type: none"> <li>1. String format: any port number</li> <li>2. The default SNMP trap port is 162</li> <li>3. A Must filled setting</li> </ol> | <p>Specify the trap <b>Server Port</b>.<br/>You can fill in any port number. But you must ensure the port number is not to be used.<br/><i>Value Range: 1 ~ 65535.</i></p>  |
| SNMP Version                           | <ol style="list-style-type: none"> <li>1. v1 is selected by default</li> </ol>  | <p>Select the version for the trap<br/>Selected the <b>v1</b>.<br/>The configuration screen will provide the version 1 must filled items.<br/>Selected the <b>v2c</b>.<br/>The configuration screen will provide the version 2c must filled items.<br/>Selected the <b>v3</b>.<br/>The configuration screen will provide the version 3 must filled items.</p> |
| Community Name                         | <ol style="list-style-type: none"> <li>1. A <b>v1</b> and <b>v2c</b> Must filled setting</li> <li>2. String format: any text</li> </ol>                             | <p>Specify the <b>Community Name</b> for this version 1 or version v2c trap.<br/><i>Value Range: 1 ~ 32 characters.</i></p>   |

|                       |   |  |
|-----------------------|---|--|
| <b>User Name</b>      | <ol style="list-style-type: none"> <li>1. A <b>v3</b> Must filled setting</li> <li>2. String format: any text</li> </ol>                    | <p>Specify the <b>User Name</b> for this version 3 trap.</p> <p><b>Value Range:</b> 1 ~ 32 characters.</p>   |
| <b>Password</b>       | <ol style="list-style-type: none"> <li>1. A <b>v3</b> Must filled setting</li> <li>2. String format: any text</li> </ol>                    | <p>When your <b>Privacy Mode</b> is <b>authNoPriv</b> or <b>authPriv</b>, you must specify the <b>Password</b> for this version 3 trap.</p> <p><b>Value Range:</b> 8 ~ 64 characters.</p>  |
| <b>Privacy Mode</b>   | <ol style="list-style-type: none"> <li>1. A <b>v3</b> Must filled setting</li> <li>2. <b>noAuthNoPriv</b> is selected by default</li> </ol> | <p>Specify the <b>Privacy Mode</b> for this version 3 trap.</p> <p>Selected the <b>noAuthNoPriv</b>.</p> <p>You do not use any authentication types and encryption protocols.</p> <p>Selected the <b>authNoPriv</b>.</p> <p>You must specify the <b>Authentication</b> and <b>Password</b>.</p> <p>Selected the <b>authPriv</b>.</p> <p>You must specify the Authentication, Password, Encryption and Privacy Key.</p> |
| <b>Authentication</b> | <ol style="list-style-type: none"> <li>1. A <b>v3</b> Must filled setting</li> <li>2. <b>None</b> is selected by default</li> </ol>         | <p>When your <b>Privacy Mode</b> is <b>authNoPriv</b> or <b>authPriv</b>, you must specify the <b>Authentication</b> types for this version 3 trap.</p> <p>Selected the authentication types <b>MD5/ SHA-1</b> to use.</p>   |
| <b>Encryption</b>     | <ol style="list-style-type: none"> <li>1. A <b>v3</b> Must filled setting</li> <li>2. <b>None</b> is selected by default</li> </ol>         | <p>When your <b>Privacy Mode</b> is <b>authPriv</b>, you must specify the <b>Encryption</b> protocols for this version 3 trap.</p> <p>Selected the encryption protocols <b>DES / AES</b> to use.</p>   |
| <b>Privacy Key</b>    | <ol style="list-style-type: none"> <li>1. A <b>v3</b> Must filled setting</li> <li>2. String format: any text</li> </ol>                    | <p>When your <b>Privacy Mode</b> is <b>authPriv</b>, you must specify the <b>Privacy Key</b> (8 ~ 64 characters) for this version 3 trap.</p>  |
| <b>Enable</b>         | <ol style="list-style-type: none"> <li>1. The box is checked by default</li> </ol>  | <p>Click <b>Enable</b> to enable this trap receiver.</p>   |
| <b>Save</b>           | N/A   | <p>Click the <b>Save</b> button to save the configuration. But it does not apply to SNMP functions. When you return to the SNMP main page. It will show "Click on save button to apply your changes" remind user to click main page <b>Save</b> button.</p>  |
| <b>Undo</b>           | N/A   | <p>Click the <b>Undo</b> button to cancel the settings.</p>  |
| <b>Back</b>           | N/A   | <p>Click the <b>Back</b> button to return the last page.</p>   |

## Specify SNMP MIB-2 System

If required, you can also specify the required information the MIB-2 System.

| SNMP MIB-2 System |                      |
|-------------------|----------------------|
| Item              | Setting              |
| ▶ sysContact      | <input type="text"/> |
| ▶ sysLocation     | <input type="text"/> |

| SNMP MIB-2 System Configuration |   |   |
|---------------------------------|---|---|
| Item                            | Value setting   | Description   |
| sysContact                      | 1. An Optional filled setting<br>2. String format: any text | Specify the contact information forMIB-2 system.<br><b>Value Range:</b> 0 ~ 64 characters.  |
| sysLocation                     | 1. An Optional filled setting<br>2. String format: any text | Specify the location information forMIB-2 system.<br><b>Value Range:</b> 0 ~ 64 characters. |

## Edit SNMP Options

If you use some particular private MIB, you must fill the enterprise name, number and OID.

| Options             |   |
|---------------------|---|
| Item                | Setting   |
| ▶ Enterprise Name   | <input type="text" value="Advantech"/>                  |
| ▶ Enterprise Number | <input type="text" value="10297"/>                      |
| ▶ Enterprise OID    | 1.3.6.1.4.1. <input type="text" value="10297.204.102"/> |

| Options             |  |
|---------------------|--|
| Item                | Setting  |
| ▶ Enterprise Name   | <input type="text" value="Default"/>                   |
| ▶ Enterprise Number | <input type="text" value="12823"/>                     |
| ▶ Enterprise OID    | 1.3.6.1.4.1. <input type="text" value="12823..4.4.9"/> |

| Options                  |  |  |
|--------------------------|--|--|
| Item                     | Value setting  | Description  |
| <b>Enterprise Name</b>   | 1. The default value is <b>Default</b><br>2. A Must filled setting<br>3. String format: any text   | Specify the <b>Enterprise Name</b> for the particular private MIB.<br><i><b>Value Range:</b> 1 ~ 10 characters, and only string with A~Z, a~z, 0~9, '-', '_'.</i>  |
| <b>Enterprise Number</b> | The default value is 12823<br>(Default Enterprise Number)<br>2. A Must filled setting<br>3. String format: any number                      | Specify the <b>Enterprise Number</b> for the particular private MIB.<br><i><b>Value Range:</b> 1 ~2080768.</i>   |
| <b>Enterprise OID</b>    | 1. The default value is 1.3.6.1.4.1.12823.4.4.9<br>(Default Enterprise OID)<br>2. A Must filled setting<br>3. String format: any legal OID | Specify the <b>Enterprise OID</b> for the particular private MIB.<br>The range of the each OID number is 1-2080768.<br>The maximum length of the enterprise OID is 31.<br>The seventh number must be identical with the enterprise number. |
| <b>Save</b>              | N/A  | Click the <b>Save</b> button to save the configuration and apply your changes to SNMP functions.   |
| <b>Undo</b>              | N/A  | Click the <b>Undo</b> button to cancel the settings.   |

### 5.1.4 Telnet & SSH

A command-line interface (CLI), also known as command-line user interface, and console user interface are means of interacting with a computer program where the user (or client) issues commands to the program in the form of successive lines of text (command lines). The interface is usually implemented with a command line shell, which is a program that accepts commands as text input and converts commands to appropriate operating system functions. Programs with command-line interfaces are generally easier to automate via scripting. The device supports both Telnet and SSH (Secure Shell) CLI with default service port 23 and 22, respectively.

#### Telnet & SSH Scenario

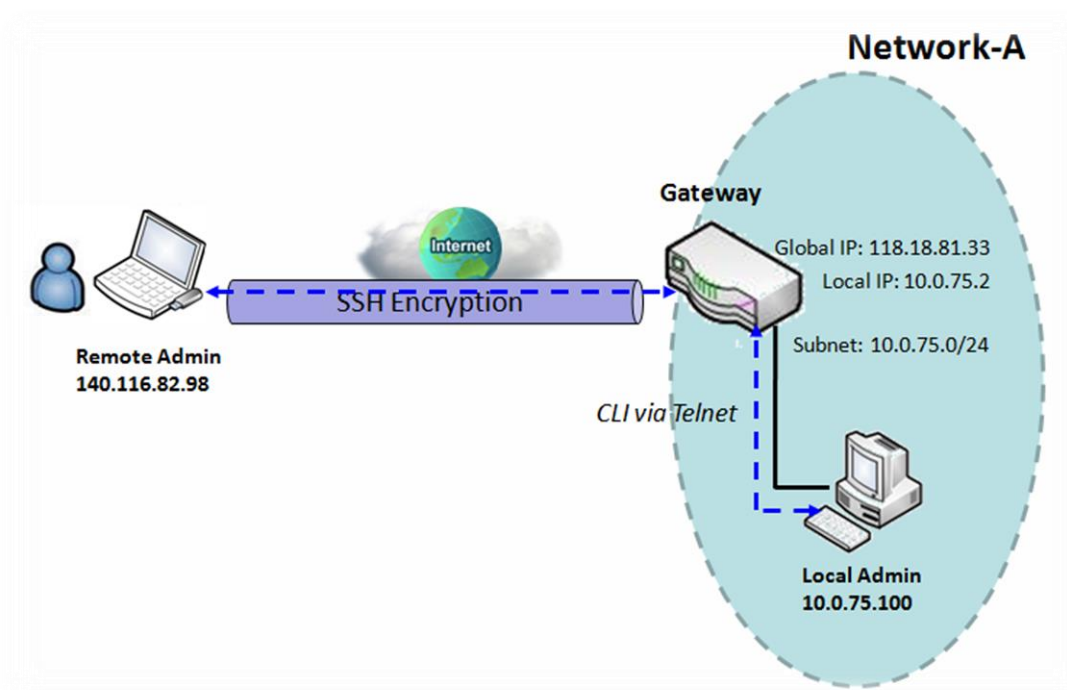

#### Scenario Application Timing

- When the administrator of the gateway wants to manage it from remote site in the Intranet or Internet, he may use "Telnet with CLI" function to do that by using "Telnet" or "SSH" utility.

#### Scenario Description

- The Local Admin or the Remote Admin can manage the Gateway by using "Telnet" or "SSH" utility with privileged user name and password.
- The data packets between the Local Admin and the Gateway or between the Remote Admin and the Gateway can be plain texts or encrypted texts. Suggest they are plain texts in the Intranet for Local Admin to use "Telnet" utility, and encrypted texts in the Internet for Remote Admin to use "SSH" utility.

### Parameter Setup Example

- Following table lists the parameter configuration as an example for the Gateway in above diagram with "Telnet with CLI" enabling at LAN and WAN interfaces.
- Use default value for those parameters that are not mentioned in the table.

| Configuration Path | [Telnet & SSH]-[Configuration]   |
|--------------------|--|
| Telnet             | LAN: <input checked="" type="checkbox"/> <i>Enable</i> WAN: <input type="checkbox"/> <i>Enable</i><br>Service Port: <b>23</b>            |
| SSH                | LAN: <input checked="" type="checkbox"/> <i>Enable</i> WAN: <input checked="" type="checkbox"/> <i>Enable</i><br>Service Port: <b>22</b> |

### Scenario Operation Procedure

- In above diagram, "Local Admin" or "Remote Admin" can manage the "Gateway" in the Intranet or Internet. The "Gateway" is the gateway of Network-A, and the subnet of its Intranet is 10.0.75.0/24. It has the IP address of 10.0.75.2 for LAN interface and 118.18.81.33 for WAN-1 interface. It serves as a NAT gateway.
- The "Local Admin" in the Intranet uses "Telnet" utility with privileged account to login the Gateway.
- Or the "Remote Admin" in the Internet uses "SSH" utility with privileged account to login the Gateway.
- The administrator of the gateway can control the device as like he is in front of the gateway.

### Telnet & SSH Setting

Go to **Administration > Configure & Manage > Telnet & SSH** tab.

The Telnet & SSH setting allows administrator to access this device through the traditional Telnet or SSH Telnet program. Before you can telnet (login) to the device, please configure the related settings and password with care. The password management part allows you to set root password for logging telnet and SSH.

| <span>Configuration</span> <span>Save</span> <span>Undo</span> |  |
|--|--|
| Item   | Setting  |
| ▶ Telnet   | LAN <input checked="" type="checkbox"/> Enable WAN <input type="checkbox"/> Enable<br>Service Port <input type="text" value="23"/> |
| ▶ SSH  | LAN <input type="checkbox"/> Enable WAN <input type="checkbox"/> Enable<br>Service Port <input type="text" value="22"/>            |

| Configuration |  |  |
|---------------|--|--|
| Item          | Value setting  | Description  |
| Telnet        | <ol style="list-style-type: none"> <li>The LAN Enable box is checked by default.</li> <li>By default <b>Service Port</b> is 23.</li> </ol> | <p>Check the <b>Enable</b> box to activate the Telnet function for connecting from LAN or WAN interfaces.</p> <p>You can set which number of <b>Service Port</b> you want to provide for the corresponding service.<br/> <b>Value Range: 1 ~65535.</b></p>     |
| SSH           | <ol style="list-style-type: none"> <li>The LAN Enable box is checked by default.</li> <li>By default <b>Service Port</b> is 22.</li> </ol> | <p>Check the <b>Enable</b> box to activate the SSH Telnet function for connecting from LAN or WAN interfaces.</p> <p>You can set which number of <b>Service Port</b> you want to provide for the corresponding service.<br/> <b>Value Range: 1 ~65535.</b></p> |
| Save          | N/A  | Click <b>Save</b> to save the settings   |
| Undo          | N/A  | Click <b>Undo</b> to cancel the settings   |

☐ Password Management

| Item   | Setting  |
|--------|--|
| ▶ root | <p>Old Password : <input style="width: 100%;" type="text"/></p> <p>New Password : <input style="width: 100%;" type="text"/></p> <p>New Password Confirmation : <input style="width: 100%;" type="text"/></p> |

| Configuration |  |  |
|---------------|--|--|
| Item          | Value setting  | Description  |
| root          | <ol style="list-style-type: none"> <li>String: any text but no blank character</li> <li>The default password for telnet is 'wirelessm2m'.</li> </ol> | <p>Type old password and specify new password to change root password.</p> <p><b>Note_1: You are highly recommended to change the default telnet password with yours before the device is deployed.</b></p> <p><b>Note_2: If you have trouble for the default password for previous FW version, please check the corresponding User Manual to get the correct one.</b></p> |
| Save          | N/A  | Click <b>Save</b> to save the settings   |
| Undo          | N/A  | Click <b>Undo</b> to cancel the settings   |

## 5.2 System Operation

System Operation allows the network administrator to manage system, settings such as web-based utility access password change, system information, system time, system log, firmware/configuration backup & restore, and reset & reboot.

### 5.2.1 Password & MMI

Go to **Administration > System Operation > Password & MMI** tab.

#### Change Host Name

Change Host Name screen allows network administrator to change the web-based MMI login account to access router.

#### Change UserName

Change Username screen allows network administrator to change the web-based MMI login account to access router. Click the **Modify** button and provide the new username setting.

| Username       |   |
|----------------|---|
| Item           | Setting                                     |
| ▶ Username     | admin <input type="button" value="Modify"/> |
| ▶ New Username | <input type="text"/>                        |
| ▶ Password     | <input type="text"/>                        |

| Username Configuration |   |   |
|------------------------|---|---|
| Item                   | Value setting   | Description   |
| Username               | 1. The default Username for web-based MMI is 'admin'. | Display the current MMI login account (Username).   |
| New Username           | String: any text                                      | Enter new Username to replace the current setting.  |
| Password               | String: any text                                      | Enter current password to verify if you have the permission to change the username setting. |
| Save                   | N/A   | Click <b>Save</b> button to save the settings   |
| Undo                   | N/A   | Click <b>Undo</b> button to cancel the settings   |



## Change Password

Change password screen allows network administrator to change the web-based MMI login password to access router.

| Password <span style="float: right;">[ Help ]</span> |                      |
|--|----------------------|
| Item   | Setting              |
| ▶ Old Password                                       | <input type="text"/> |
| ▶ New Password                                       | <input type="text"/> |
| ▶ New Password Confirmation                          | <input type="text"/> |

| Password Configuration    |  |   |
|---------------------------|--|---|
| Item                      | Value setting  | Description   |
| Old Password              | 1. String: any text<br>2. The default password for web-based MMI is 'admin'. | Enter the current password to enable you unlock to change password. |
| New Password              | String: any text   | Enter new password  |
| New Password Confirmation | String: any text   | Enter new password again to confirm                                 |
| Save                      | N/A  | Click <b>Save</b> button to save the settings                       |
| Undo                      | N/A  | Click <b>Undo</b> button to cancel the settings                     |

## Change MMI Setting for Accessing

This is the router’s web-based MMI access which allows administrator to access the router for management. The router’s web-based MMI will automatically logout when the idle time has elapsed. The setting allows administrator to enable automatic logout and set the logout idle time. When the login timeout is disabled, the system won’t logout the administrator automatically.

| MMI [ Help ]              |   |
|---------------------------|---|
| Item                      | Setting   |
| ▶ Login                   | Password-Guessing Attack & MAX: <input type="text" value="3"/> (times)  |
| ▶ Login Timeout           | <input checked="" type="checkbox"/> Enable <input type="text" value="300"/> (seconds)   |
| ▶ GUI Access Protocol     | <input type="text" value="http/https"/> ▼   |
| ▶ HTTPs Certificate Setup | <input checked="" type="radio"/> default<br><input type="radio"/> Select from Certificate List<br>Certificate: <input type="text"/> Key: <input type="text"/> |
| ▶ HTTP Compression        | <input type="checkbox"/> gzip <input type="checkbox"/> deflate  |
| ▶ HTTP Binding            | <input checked="" type="checkbox"/> DHCP 1  |
| ▶ System Boot Mode        | <input type="text" value="Normal Mode"/> ▼  |

| MMI Configuration       |   |   |
|-------------------------|---|---|
| Item                    | Value setting   | Description   |
| Login                   | 3 times is set by default                             | Enter the login trial counting value.<br><b>Value Range: 3 ~ 10.</b><br>If someone tried to login the web GUI with incorrect password for more than the counting value, an warning message “ <b>Already reaching maximum Password-Guessing times, please wait a few seconds!</b> ” will be displayed and ignore the following login trials. |
| Login Timeout           | The Enable box is checked, and 300 is set by default. | Check the Enable box to activate the auto logout function, and specify the maximum idle time as well.<br><b>Value Range: 30 ~ 65535.</b>  |
| GUI Access Protocol     | <b>http/https</b> is selected by default.             | Select the protocol that will be used for GUI access. It can be <b>http/https</b> , <b>http only</b> , or <b>https only</b> .   |
| HTTPs Certificate Setup | The <b>default</b> box is selected by default         | If the https Access Protocol is selected, the HTTPs Certificate Setup option will be available for further configuration.<br>You can leave it as default or select an expected certificate and key from the drop down list.<br>Refer to <b>Object Definition &gt; Certificate</b> Section for the Certificate configuration.                |
| HTTP Compression        | The box is unchecked by default.                      | Check the box ( <b>gzip</b> , or <b>deflate</b> ) if any compression method is preferred.   |

|                         |  |   |
|-------------------------|--|---|
| <b>HTTP Binding</b>     | A Must filled setting                      | Select <b>HTTP Binding</b> .  |
| <b>System Boot Mode</b> | <b>Normal Mode</b> is selected by default. | Select the system boot mode that will be adopted to boot up the device.<br><b>Normal Mode:</b> It takes longer boot up time, about 200 seconds, with complete firmware image check during the device booting.<br><b>Fast Mode:</b> It takes shorter boot up time, about 120 seconds, without checking the firmware image during the device booting.<br><b>Quick Mode:</b> It takes shorter boot up time, about 90 seconds, without checking the firmware image and create the internal database for User/Group/Captive Portal functions.<br><br><b>Note:</b> Use <b>Quick Mode</b> with care, once selected, the User/Group/Captive Portal function will become non-functional. |
| <b>Save</b>             | N/A  | Click <b>Save</b> button to save the settings   |
| <b>Undo</b>             | N/A  | Click <b>Undo</b> button to cancel the settings   |

## 5.2.2 System Information

System Information screen gives network administrator a quick look up on the device information for the purchased router.

Go to **Administration > System Operation > System Information** tab.

| System Information     |                                 |
|------------------------|---------------------------------|
| Item                   | Setting                         |
| ▶ Model Name           | ICR-1601W                       |
| ▶ Device Serial Number | ZZ18700030                      |
| ▶ Kernel Version       | 2.6.36                          |
| ▶ FW Version           | 0CN0XJW.I71_e72.0CN0_08101800   |
| ▶ CPU Usage            | 7.92%                           |
| ▶ Memory Usage         | 50%                             |
| ▶ System Time          | Fri, 14 Sep 2018 12:51:51 +0000 |
| ▶ Device Up-Time       | 0day 8hr 4min 36sec             |

| System Information          |               |   |
|-----------------------------|---------------|---|
| Item                        | Value Setting | Description   |
| <b>Model Name</b>           | N/A           | It displays the model name of this product.         |
| <b>Device Serial Number</b> | N/A           | It displays the serial number of this product.      |
| <b>Kernel Version</b>       | N/A           | It displays the Linux kernel version of the product |
| <b>FW Version</b>           | N/A           | It displays the firmware version of the product     |
| <b>CPU Usage</b>            | N/A           | It displays the percentage of CPU utilization.      |

|                       |     |   |
|-----------------------|-----|---|
| <b>Memory Usage</b>   | N/A | It displays the percentage of device memory utilization.                      |
| <b>System Time</b>    | N/A | It displays the current system time that you browsed this web page.           |
| <b>Device Up-Time</b> | N/A | It displays the statistics for the device up-time since last boot up.         |
| <b>Refresh</b>        | N/A | Click the <b>Refresh</b> button to update the system Information immediately. |

### 5.2.3 System Time

The router provides manually setup and auto-synchronized approaches for the administrator to setup the system time for the router.

Go to **Administration > System Operation > System Time** tab.

**System Time Configuration**

| Item                      | Setting   |
|---------------------------|---|
| ▶ Synchronization method  | Time Server ▼   |
| ▶ Time Zone               | (GMT+00:00) Greenwich Mean Time: Dublin, Edinburgh, Lisbon, London ▼          |
| ▶ Auto-synchronization    | Time Server: <input type="text"/><br>Available Time Servers (RFC-868): Auto ▼ |
| ▶ Daylight Saving Time    | <input type="checkbox"/> Enable   |
| ▶ NTP Service             | <input type="checkbox"/> Enable   |
| ▶ Synchronize immediately | <input type="button" value="Active"/>   |

| System Time Information       |  |   |
|-------------------------------|--|---|
| Item                          | Value Setting  | Description   |
| <b>Synchronization method</b> | 1. A must fill setting.<br>2. <b>Time Server</b> is selected by default.   | Select the synchronization method from <b>Time Server</b> , <b>Manual</b> , <b>PC</b> or <b>Cellular Module</b> .   |
| <b>Time Zone</b>              | 1. It is an optional item.<br>2. <b>GMT+00 :00</b> is selected by default. | Select a time zone where this device locates.   |
| <b>Auto-synchronization</b>   | 1. Checked by default.<br>2. Auto is selected by default.                  | Check the <b>Enable</b> button to activate the time auto-synchronization function with a certain NTP server.<br>You can enter the IP or FQDN for the NTP server you expected, or leave it as auto mode so that the available server will be used for time synchronization one by one. |
| <b>Daylight Saving Time</b>   | 1. It is an optional item.<br>2. Un-checked by default                     | Check the <b>Enable</b> button to activate the daylight saving function.<br>When you enabled this function, you have to specify the start date and end date for the daylight saving time duration.  |
| <b>Set Date &amp; Time</b>    | 1. It is an optional item.   | If you do not enable the time auto-synchronization function, you can also manually set the date (Year/Month/Day) and time (Hour:Minute:Second).   |
| <b>NTP Service</b>            | 1. Unchecked by default.<br>2. NTP Service is                              | Check the <b>Enable</b> button to activate the NTP service.   |

|                                |                      |  |
|--------------------------------|----------------------|--|
|                                | disabled by default. |  |
| <b>Synchronize immediately</b> | N/A                  | Click the <b>Active</b> button to synchronize time immediately.        |
| <b>Save</b>                    | N/A                  | Click the <b>Save</b> button to save the settings.                     |
| <b>Refresh</b>                 | N/A                  | Click the <b>Refresh</b> button to update the system time immediately. |

Instead of manually configuring the system time for the router, there are two simple and quick solutions for you to set the correct time information and set it as the system time for the router.

The first one is “Sync with Timer Server”. Based on your selection of time zone and time server in above time information configuration window, system will communicate with time server by NTP Protocol to get system date and time after you click on the **Sync with Timer Server** button.

**Note:** Remember to select a correct time zone for the device, otherwise, you will just get the UTC (Coordinated Universal Time) time, not the local time for the device.

The second one is “Sync with my PC”. Click on the **Sync with my PC** button to let system synchronize its date and time to the time of the administration PC.

## 5.2.4 System Log

System Log screen contains various event log tools facilitating network administrator to perform local event logging and remote reporting.

Go to **Administration > System Operation > System Log** tab.

System Log View Email Now

| Item                           | Setting  |
|--------------------------------|--|
| <p>▶ Web Log Type Category</p> | <input checked="" type="checkbox"/> System <input checked="" type="checkbox"/> Attacks <input checked="" type="checkbox"/> Drop <input checked="" type="checkbox"/> Login message <input type="checkbox"/> Debug   |
| <p>▶ Email Alert</p>           | <input type="checkbox"/> Enable<br>Server: <span>--- Option ---</span> <span>Add Object</span><br>E-mail Addresses: <div style="border: 1px solid #ccc; height: 40px; width: 100%;"></div><br>Subject: <input type="text"/><br>Log type Category: <input type="checkbox"/> System <input type="checkbox"/> Attacks <input type="checkbox"/> Drop <input type="checkbox"/> Login message <input type="checkbox"/> Debug   |
| <p>▶ Syslog</p>                | <input type="checkbox"/> Enable   Server: <span>--- Option ---</span> <span>Add Object</span><br>Log type Category: <input type="checkbox"/> System <input type="checkbox"/> Attacks <input type="checkbox"/> Drop <input type="checkbox"/> Login message <input type="checkbox"/> Debug   |
| <p>▶ Log to Storage</p>        | <input type="checkbox"/> Enable<br>Select Device: <span>Internal</span> <span>▼</span><br>Log file name: <input type="text" value="syslog"/><br>Split file: <input type="checkbox"/> Enable   Size: <input type="text" value="200"/> <span>KB</span> <span>▼</span><br><span>Download log file</span><br>Log type Category: <input type="checkbox"/> System <input type="checkbox"/> Attacks <input type="checkbox"/> Drop <input type="checkbox"/> Login message <input type="checkbox"/> Debug |

## View & Email Log History

**View** button is provided for network administrator to view log history on the router. **Email Now** button enables administrator to send instant Email for analysis.

| View & Email Log History |               |  |
|--------------------------|---------------|--|
| Item                     | Value setting | Description  |
| View button              | N/A           | Click the <b>View</b> button to view Log History in Web Log List Window.   |
| Email Now button         | N/A           | Click the <b>Email Now</b> button to send Log History via Email instantly. |

| <input type="checkbox"/> Web Log List <input type="button" value="Previous"/> <input type="button" value="Next"/> <input type="button" value="First"/> <input type="button" value="Last"/> <input type="button" value="Download"/> <input type="button" value="Clear"/> |  |
|---|--|
| Time  | Log  |
| Sep 14 04:47:20   | BusyBox(csm lib) v1.3.2  |
| Sep 14 04:47:20   | kernel: klogd started: BusyBox v1.3.2 (2018-08-10 15:40:12 CST)(csm lib)   |
| Sep 14 04:47:20   | csmn: hookcs_load[299]: section_tag cmark:0x07 secid:0x07 magic:0x2B24 ts:0x00000024 imglen:0x000035C8 imgchk:0xAC8D tagchk:0xEB5A |
| Sep 14 04:47:20   | csmn: hookcs_load[299]: section_tag cmark:0x07 secid:0x07 magic:0x2B24 ts:0x00000025 imglen:0x000035D4 imgchk:0xECFC tagchk:0xAADE |
| Sep 14 04:47:20   | csmn: C section 2 is up to date, load C section 2...   |
| Sep 14 04:47:24   | commander: commander: System is in Normal mode: 0, do untarmysql script  |
| Sep 14 04:47:25   | BEID: BEID STATUS : 0 , STATUS OK!   |
| Sep 14 04:47:25   | vlan2: Running TagBase VLAN  |
| Sep 14 04:47:27   | commander: NETWORK Initialization finished. Result: 0  |
| Sep 14 04:47:27   | commander: init vlan   |
| Sep 14 04:47:27   | commander: init lan  |
| Sep 14 04:47:28   | commander: init stp  |
| Sep 14 04:47:28   | commander: init ondemand   |
| Sep 14 04:47:28   | commander: init multiwan2  |
| Sep 14 04:47:28   | commander: Initialize MultiWAN   |

Page: 1/23 (Log Number: 345)

| Web Log List Window |               |                               |
|---------------------|---------------|-------------------------------|
| Item                | Value Setting | Description                   |
| Time column         | N/A           | It displays event time stamps |
| Log column          | N/A           | It displays Log messages      |

| Web Log List Button Description |               |   |
|---------------------------------|---------------|---|
| Item                            | Value setting | Description   |
| Previous                        | N/A           | Click the <b>Previous</b> button to move to the previous page.                  |
| Next                            | N/A           | Click the <b>Next</b> button to move to the next page.                          |
| First                           | N/A           | Click the <b>First</b> button to jump to the first page.                        |
| Last                            | N/A           | Click the <b>Last</b> button to jump to the last page.                          |
| Download                        | N/A           | Click the <b>Download</b> button to download log to your PC in tar file format. |
| Clear                           | N/A           | Click the <b>Clear</b> button to clear all log.                                 |
| Back                            | N/A           | Click the <b>Back</b> button to return to the previous page.                    |

### Web Log Type Category

Web Log Type Category screen allows network administrator to select the type of events to log and be displayed in the Web Log List Window as described in the previous section. Click on the View button to view Log History in the Web Log List window.

Web Log Type Category
  System
  Attacks
  Drop
  Login message
  Debug

| Web Log Type Category Setting Window |                       |   |
|--------------------------------------|-----------------------|---|
| Item                                 | Value Setting         | Description   |
| System                               | Checked by default    | Check to log system events and to display in the Web Log List window.       |
| Attacks                              | Checked by default    | Check to log attack events and to display in the Web Log List window.       |
| Drop                                 | Checked by default    | Check to log packet drop events and to display in the Web Log List window.  |
| Login message                        | Checked by default    | Check to log system login events and to display in the Web Log List window. |
| Debug                                | Un-checked by default | Check to log debug events and to display in the Web Log List window.        |

### Email Alert

Email Alert screen allows network administrator to select the type of event to log and be sent to the destined Email account.

Enable  
 Server:    
 E-mail Addresses:   
 Subject:   
 Log type Category:
  System
  Attacks
  Drop
  Login message
  Debug

| Email Alert Setting Window |                       |   |
|----------------------------|-----------------------|---|
| Item                       | Value Setting         | Description   |
| Enable                     | Un-checked by default | Check <b>Enable</b> box to enable sending event log messages to destined Email account defined in the E-mail Addresses blank space.   |
| Server                     | N/A                   | Select one email server from the Server dropdown box to send Email. If none has been available, click the <b>Add Object</b> button to create an outgoing Email server.<br>You may also add an outgoing Email server from Object Definition > External Server > External Server tab. |
| E-mail address             | String : email format | Enter the recipient’s Email address. Separate Email addresses with comma ‘,’ or semicolon ‘;’<br>Enter the Email address in the format of ‘myemail@domain.com’  |
| Subject                    | String : any text     | Enter an Email subject that is easy for you to identify on the Email client.  |
| Log type category          | Default unchecked     | Select the type of events to log and be sent to the designated Email account. Available events are System, Attacks, Drop, Login message, and Debug.   |

### Syslogd

Syslogd screen allows network administrator to select the type of event to log and be sent to the designated Syslog server.

Syslogd
  Enable
 Server: --- Option ---

  
 Log type Category:
  System
  Attacks
  Drop
  Login message
  Debug

#### Syslogd Setting Window

| Item              | Value Setting         | Description   |
|-------------------|-----------------------|---|
| Enable            | Un-checked by default | Check Enable box to activate the Syslogd function, and send event logs to a syslog server   |
| Server            | N/A                   | Select one syslog server from the Server dropdown box to send event log to. If none has been available, click the <b>Add Object</b> button to create a system log server. You may also add an system log server from the Object Definition > External Server > External Server tab. |
| Log type category | Un-checked by default | Select the type of event to log and be sent to the destined syslog server. Available events are System, Attacks, Drop, Login message, and Debug.  |

### Log to Storage

Log to Storage screen allows network administrator to select the type of events to log and be stored at an internal or an external storage.

Log to Storage
  Enable
 Select Device: Internal
  
 Log file name: 
  
 Split file:
  Enable
 Size:  KB
  

  
 Log type Category:
  System
  Attacks
  Drop
  Login message
  Debug

#### Log to Storage Setting Window

| Item              | Value Setting                   | Description   |
|-------------------|---------------------------------|---|
| Enable            | Un-checked by default           | Check to enable sending log to storage.   |
| Select Device     | Internal is selected by default | Select internal or external storage.  |
| Log file name     | Un-checked by default           | Enter log file name to save logs in designated storage.                               |
| Split file Enable | Un-checked by default           | Check <b>enable</b> box to split file whenever log file reaching the specified limit. |
| Split file Size   | 200 KB is set by default        | Enter the file size limit for each split log file.<br><i>Value Range: 10 ~1000.</i>   |
| Log type category | Un-checked by default           | Check which type of logs to send: System, Attacks, Drop, Login message, Debug         |

#### Log to Storage Button Description

| Item              | Value setting | Description  |
|-------------------|---------------|--|
| Download log file | N/A           | Click the <b>Download log file</b> button to download log files to a log.tar file. |



### 5.2.5 Backup & Restore

In the Backup & Restore window, you can upgrade the device firmware when new firmware is available and also backup / restore the device configuration.

In addition to the factory default settings, you can also customize a special configuration setting as a customized default value. With this customized default value, you can reset the device to the expected default setting if needed. Also, the regular Auto Upgrade via HTTP(S)/FTP(S) source is feasible.

Go to **Administration > System Operation > Backup & Restore** tab.

| FW Backup & Restore             |   |
|---------------------------------|---|
| Item                            | Setting   |
| ▶ FW Upgrade                    | Via Web UI ▾ <input type="button" value="FW Upgrade"/>  |
| ▶ Backup Configuration Settings | Download ▾ <input type="button" value="Via Web UI"/>  |
| ▶ Auto Restore Configuration    | <input type="checkbox"/> Enable <input type="button" value="Save Conf."/> <input type="button" value="Clean Conf."/> <input type="button" value="Conf. Info."/>   |
| ▶ Self-defined Logo             | Last modified:17. 9. 2018 7:50:48<br>Download ▾ <input type="button" value="Via Web UI"/> <input type="button" value="Reset"/>                                    |
| ▶ Self-defined CSS              | <input type="button" value="Edit"/> Last modified:1. 1. 2018 1:01:30<br>Download ▾ <input type="button" value="Via Web UI"/> <input type="button" value="Reset"/> |

| FW Backup & Restore                  |  |   |
|--------------------------------------|--|---|
| Item                                 | Value Setting                          | Description   |
| <b>FW Upgrade</b>                    | Via Web UI is selected by default      | If new firmware is available, click the <b>FW Upgrade</b> button to upgrade the device firmware <b>via Web UI</b> , or <b>Via Storage</b> .<br>After clicking on the “FW Upgrade” command button, you need to specify the file name of new firmware by using “Browse” button, and then click “Upgrade” button to start the FW upgrading process on this device. If you want to upgrade a firmware which is from GPL policy, please check “Accept unofficial firmware” |
| <b>Backup Configuration Settings</b> | Download is selected by default        | You can backup or restore the device configuration settings by clicking the <b>Via Web UI</b> button.<br><b>Download:</b> for backup the device configuration to a config.bin file.<br><b>Upload:</b> for restore a designated configuration file to the device.<br><b>Via Web UI:</b> to retrieve the configuration file via Web GUI.  |
| <b>Auto Restore Configuration</b>    | The Enable box is unchecked by default | Click the <b>Enable</b> button to activate the customized default setting function. Once the function is activated, you can save the expected setting as a customized default setting by clicking the <b>Save Conf.</b> button, or clicking the <b>Clean Conf.</b> button to erase the stored customized configuration.   |
| <b>Self-defined Logo</b>             | Download is selected by default.       | The logo for the web UI can be downloaded or uploaded from or to the router.<br>Note: The file name must be “logo.gif”.   |
| <b>Self-defined CSS</b>              | Download is selected by default.       | The style of web UI can be downloaded or uploaded from or to the router through the CSS file. The CCS style can also be edited directly by Edit button.<br>Note: The file name must be “wmqa01.css”.  |

Auto Upgrade via HTTP(S)/FTP(S) source can be configured in the bottom part. If the Firmware or Configuration found on the server is newer than the current one, it will be updated.

| Auto Upgrade  |   |
|---------------|---|
| Item          | Setting   |
| ▶ Enable      | <input type="checkbox"/> Firmware <input type="checkbox"/> Config <input type="text" value="config.ver example"/> |
| ▶ Source      | HTTP(S) / FTP(S) ▼  |
| ▶ Base URL    | <input type="text"/>  |
| ▶ Unit ID     | <input type="text"/>  |
| ▶ Update Hour | <input type="text" value="0"/> (24~720 hours) <input type="checkbox"/> Auto update after turning on the router    |

| Auto Upgrade       |  |   |
|--------------------|--|---|
| Item               | Value Setting  | Description   |
| <b>Enable</b>      | The boxes are unchecked by default.                      | Enable Firmware or Configuration upgrade or both:<br><b>Firmware:</b> the router will look for a newer firmware file and update when found.<br><b>Config:</b> the router will check if there is a configuration file on the remote server with newer date than the current configuration, it will update its configuration to the new settings and reboot.<br><br><b>config .ver example</b> button will prompt the download of .ver file example needed on server for Config update. See the explanation in <b>HTTP(S) / FTP(S) Server configuration</b> part below the table. |
| <b>Source</b>      | HTTP(S) / FTP(S) is selected by default                  | Select the location of the upgrade files:<br><b>HTTP(S) / FTP(S):</b> Updates are downloaded from the Base URL address below. Used protocol is specified by the address: HTTP, HTTPS, FTP or FTPS.  |
| <b>Base URL</b>    | Blank is set by default                                  | IP address from which the configuration file will be downloaded. This option also specifies the communication protocol. Example: <b>http://example.com</b>  |
| <b>Unit ID</b>     | 1. An optional setting<br>2. Blank is set by default     | Name of configuration file (name of the file without extension). If not filled, the MAC address of the router is used as the filename (the dots are used as delimiter instead of colons.)   |
| <b>Update Hour</b> | 0 is set by default.<br>The box is unchecked by default. | Set the time (range 24 to 720 hours) to regularly check for updates.<br>If the <b>Auto update after turning on the router</b> box is enabled, the check is performed five minutes after every turning on the router (reboot). If the detected firmware or configuration file is newer than the running one, it is downloaded and the router is rebooted automatically.  |

## HTTP(S) / FTP(S) Server configuration:

To make Auto Upgrade working, both the Firmware and Config file need to have a .ver file stored in the same folder on HTTP(S) / FTP(S) server. The updates are triggered by the content of the .ver files (newer date).

- For the firmware, the .ver file will come with the general release. Upload both Firmware files **.bin** and **.ver** in the same folder.
- For the configuration file, .ver file example can be generated by the **config .ver example** button in the Enable row in the router Auto Upgrade configuration. Both **config.bin** and **.ver** files have to be uploaded in the same folder. The name of .ver file and config.bin has to be the same. It can be the chosen Unit ID or MAC (note that when the parameter Unit ID is filled, the configuration filename is defined, and the hardware MAC address name will not be used). Edit the time on .ver file for configuration to make sure the configuration will be updated.

Example of the Firmware and Configuration files on the HTTP(S) / FTP(S) server:

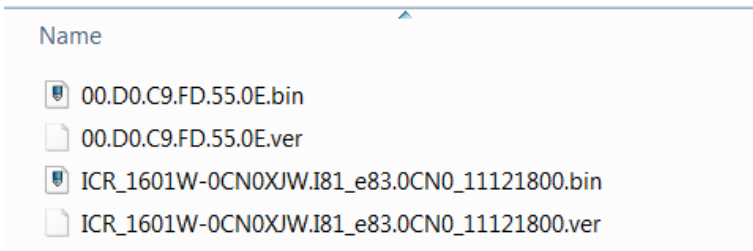

Example of the configuration .ver file content (date including hours in format YYYYMMDDHH):

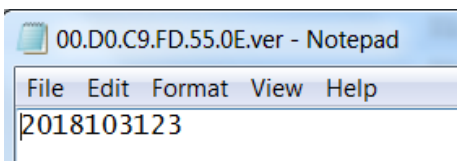

### 5.2.6 Reboot & Reset

For some special reason or situation, you may need to reboot the router or reset the device configuration to its default value. In addition to perform these operations through the Power ON/OFF, or pressing the reset button on the device panel, you can do it through the web GUI too.

Go to **Administration > System Operation > Reboot & Reset** tab.

In the Reboot & Reset window, you can reboot this device by clicking the “Reboot” button, and reset this device to default settings by clicking the “Reset” button.

| System Operation   |   |
|--------------------|---|
| Item               | Setting                                   |
| ▶ Reboot           | Now <input type="button" value="Reboot"/> |
| ▶ Reset to Default | <input type="button" value="Reset"/>      |

| System Operation Window |                            |  |
|-------------------------|----------------------------|--|
| Item                    | Value Setting              | Description  |
| Reboot                  | Now is selected by default | Click the <b>Reboot</b> button to reboot the router immediately or on a pre-defined time schedule.<br><b>Now:</b> Reboot immediately<br><b>Time Schedule:</b> Select a pre-defined auto-reboot time schedule rule to reboot the auto device on a designated time. To define a time schedule rule, go to <b>Object Definition &gt; Scheduling &gt; Configuration</b> tab. |
| Reset to Default        | N/A                        | Click the <b>Reset</b> button to reset the device configuration to its default value.  |

### 5.3 Diagnostic

This router supports simple network diagnosis tools for the administrator to troubleshoot and find the root cause of the abnormal behavior or traffics passing through the router. There can be a Packet Analyzer to help record the packets for a designated interface or specific source/destination host, and another Ping and Tracert tools for testing the network connectivity issues.

#### 5.3.1 Diagnostic Tools

The Diagnostic Tools provide some frequently used network connectivity diagnostic tools (approaches) for the network administrator to check the device connectivity.

Go to **Administration > Diagnostic > Diagnostic Tools** tab.

| Diagnostic Tools |   |
|------------------|---|
| Item             | Setting   |
| ▶ Ping Test      | Host IP: <input type="text"/> Outer Interface: <span>Auto</span> LAN Source: <span>Default</span> <span>Ping</span> |
| ▶ Tracert Test   | Host IP: <input type="text"/> Interface: <span>Auto</span> <span>UDP</span> <span>Tracert</span>                    |
| ▶ Wake on LAN    | <input type="text"/> <span>Wake up</span>   |

| Diagnostic Tools    |                  |  |
|---------------------|------------------|--|
| Item                | Value setting    | Description  |
| <b>Ping Test</b>    | Optional Setting | This allows you to specify an IP / FQDN and the test interface (LAN, WAN, or Auto), so system will try to ping the specified device to test whether it is alive after clicking on the <b>Ping</b> button. A test result window will appear beneath it.   |
| <b>Tracert Test</b> | Optional setting | Trace route (tracert) command is a network diagnostic tool for displaying the route (path) and measuring transit delays of packets across an IP network. Trace route proceeds until all (three) sent packets are lost for more than twice, then the connection is lost and the route cannot be evaluated. First, you need to specify an IP / FQDN, the test interface (LAN, WAN, or Auto) and the protocol (UDP or ICMP), and by default, it is <b>UDP</b> . Then, system will try to trace the specified host to test whether it is alive after clicking on <b>Tracert</b> button. A test result window will appear beneath it. |
| <b>Wake on LAN</b>  | Optional setting | Wake on LAN (WOL) is an Ethernet networking standard that allows a computer to be turned on or awakened by a network message. You can specify the MAC address of the computer, in your LAN network, to be remotely turned on by clicking on the <b>Wake up</b> command button.   |
| <b>Save</b>         | N/A              | Click the <b>Save</b> button to save the configuration.  |

### 5.3.2 Packet Analyzer



The Packet Analyzer can capture packets depend on user settings. User can specify interfaces to capture packets and filter by setting rule. Ensure the log storage is available (either embedded SD-Card or external USB Storage), otherwise **Packet Analyzer** cannot be enabled.

Go to **Administration > Diagnostic > Packet Analyzer** tab.

| Configuration       |   |
|---------------------|---|
| Item                | Setting   |
| ▶ Packet Analyzer   | <input type="checkbox"/> Enable   |
| ▶ File Name         | <input type="text"/>  |
| ▶ Split Files       | <input type="checkbox"/> Enable File Size : <input type="text" value="200"/> <input type="text" value="KB"/>                          |
| ▶ Packet Interfaces | <input type="checkbox"/> WAN-1 <input type="checkbox"/> WAN-2<br>2.4G : <input type="checkbox"/> VAP-1 <input type="checkbox"/> VAP-2 |

| Configuration     |  |   |
|-------------------|--|---|
| Item              | Value setting  | Description   |
| Packet Analyzer   | The box is unchecked by default.   | Check <b>Enable</b> box to activate the Packet Analyzer function.<br>If you cannot enable the checkbox, please check if the storage is available or not. Plug in the USB storage and then enable the Package Analyzer function.   |
| File Name         | 1. An optional setting<br>2. Blank is set by default, and the default file name is <b>&lt;Interface&gt;_&lt;Date&gt;_&lt;index&gt;</b> . | Enter the file name to save the captured packets in log storage.<br>If <b>Split Files</b> option is also enabled, the file name will be appended with an index code “_<index>”.<br>The extension file name is <b>.pcap</b> .  |
| Split Files       | 1. An optional setting<br>2. The default value of <b>File Size</b> is 200 KB.  | Check <b>enable</b> box to split file whenever log file reaching the specified limit.<br>If the <b>Split Files</b> option is enabled, you can further specify the <b>File Size</b> and <b>Unit</b> for the split files.<br><b>Value Range: 10 ~ 99999</b> .<br>NOTE: <b>File Size</b> cannot be less than 10 KB   |
| Packet Interfaces | An optional setting  | Define the interface(s) that <b>Packet Analyzer</b> should work on.<br>At least, one interface is required, but multiple selections are also accepted.<br>The supported interfaces can be: <ul style="list-style-type: none"> <li>● <b>WAN</b>: When the WAN is enabled at <b>Physical Interface</b>, it can be selected here.</li> <li>● <b>VAP</b>: This means the virtual AP. When WiFi and VAP are enabled, it can be selected here.</li> </ul> |
| Save              | N/A  | Click the <b>Save</b> button to save the configuration.   |
| Undo              | N/A  | Click the <b>Undo</b> button to restore what you just configured back to the previous setting.  |

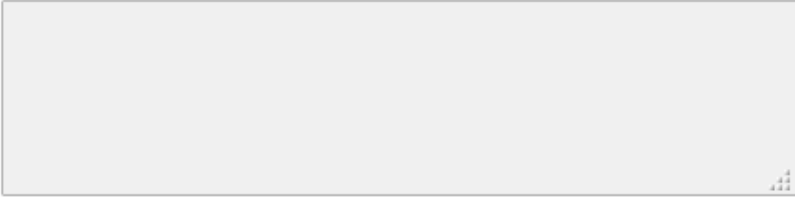
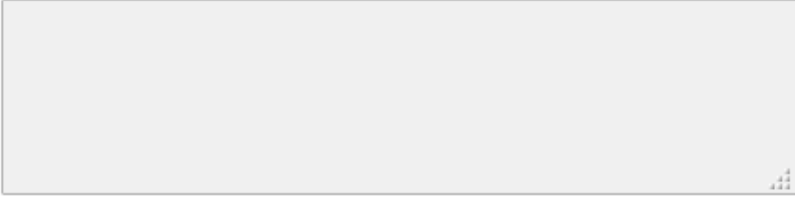
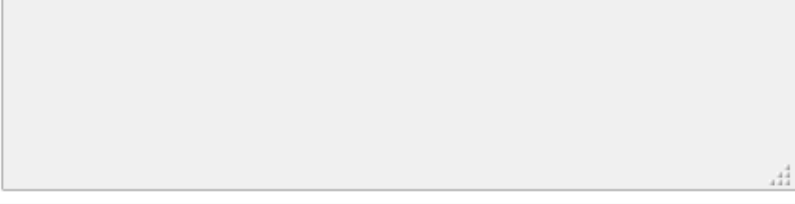
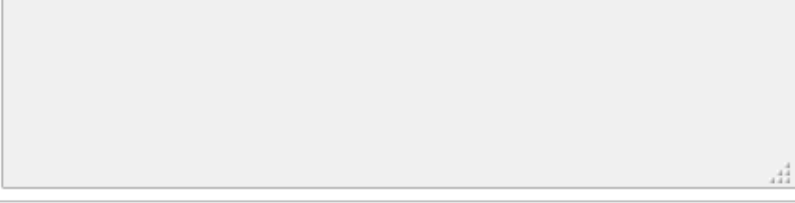
Once you enabled the Packet Analyzer function on specific Interface(s), you can further specify some filter rules to capture the packets which matched the rules.

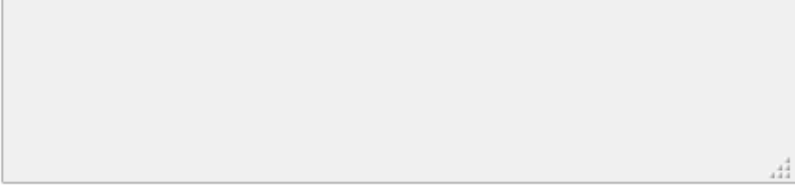
| <input type="checkbox"/> Capture Filters |  |
|--|--|
| Item                                     | Setting  |
| ▶ Filter                                 | <input type="checkbox"/> Enable  |
| ▶ Source MACs                            |    |
| ▶ Source IPs                             |    |
| ▶ Source Ports                           |   |
| ▶ Destination MACs                       |  |
| ▶ Destination IPs                        |  |
| ▶ Destination Ports                      |  |

| Capture Filters   |                  |   |
|-------------------|------------------|---|
| Item              | Value setting    | Description   |
| Filter            | Optional setting | Check <b>Enable</b> box to activate the Capture Filter function.  |
| Source MACs       | Optional setting | Define the filter rule with <b>Source MACs</b> , which means the source MAC address of packets.<br>Packets which match the rule will be captured.<br>Up to 10 MACs are supported, but they must be separated with “;”,<br>e.g. AA:BB:CC:DD:EE:FF; 11:22:33:44:55:66<br>The packets will be captured when match any one MAC in the rule.           |
| Source IPs        | Optional setting | Define the filter rule with <b>Source IPs</b> , which means the source IP address of packets.<br>Packets which match the rule will be captured.<br>Up to 10 IPs are supported, but they must be separated with “;”,<br>e.g. 192.168.1.1; 192.168.1.2<br>The packets will be captured when match any one IP in the rule.                           |
| Source Ports      | Optional setting | Define the filter rule with <b>Source Ports</b> , which means the source port of packets.<br>The packets will be captured when match any port in the rule.<br>Up to 10 ports are supported, but they must be separated with “;”,<br>e.g. 80; 53<br><b>Value Range: 1 ~ 65535.</b>   |
| Destination MACs  | Optional setting | Define the filter rule with <b>Destination MACs</b> , which means the destination MAC address of packets.<br>Packets which match the rule will be captured.<br>Up to 10 MACs are supported, but they must be separated with “;”,<br>e.g. AA:BB:CC:DD:EE:FF; 11:22:33:44:55:66<br>The packets will be captured when match any one MAC in the rule. |
| Destination IPs   | Optional setting | Define the filter rule with <b>Destination IPs</b> , which means the destination IP address of packets.<br>Packets which match the rule will be captured.<br>Up to 10 IPs are supported, but they must be separated with “;”,<br>e.g. 192.168.1.1; 192.168.1.2<br>The packets will be captured when match any one IP in the rule.                 |
| Destination Ports | Optional setting | Define the filter rule with <b>Destination Ports</b> , which means the destination port of packets.<br>The packets will be captured when match any port in the rule.<br>Up to 10 ports are supported, but they must be separated with “;”,<br>e.g. 80; 53<br><b>Value Range: 1 ~ 65535.</b>   |



## 6. Service

### 6.1 Cellular Toolkit

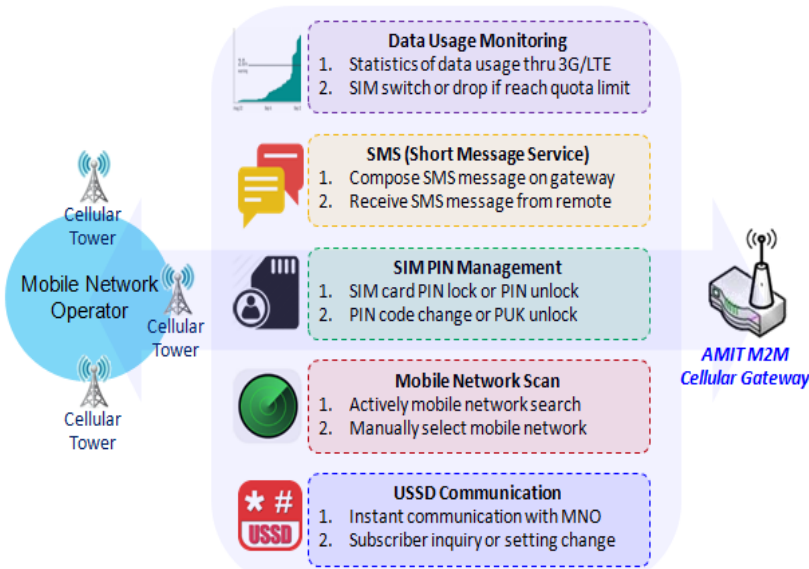

Besides cellular data connection, you may also like to monitor data usage of cellular WAN, sending text message through SMS, changing PIN code of SIM card or doing a cellular network scan for diagnostic purpose.

In Cellular Toolkit section, it includes several useful features that are related to cellular configuration or application. You can configure settings of Data Usage, SMS, SIM PIN, and Network Scan here. Please note at least a valid SIM card is required to be inserted to device before you continue settings in this section.

- Status
- Basic Network
- Object Definition
- Security
- Administration
- Service
- Cellular Toolkit
- SMS & Event

Data Usage
SMS
SIM PIN
Network Scan

3G/4G Data Usage Profile List
Add
Delete

| ID | SIM info | Carrier Name | Cycle Period | Start Date | Data Limitation | Connection Restrict | Enable | Action |
|----|----------|--------------|--------------|------------|-----------------|---------------------|--------|--------|
|    |          |              |              |            |                 |                     |        |        |

### 6.1.1 Data Usage

Most of data plan for cellular connection is with a limited amount of data usage. If data usage has been over limited quota, either you will get much lower data throughput that may affect your daily operation, or you will get a ‘bill shock’ in the next month because carrier/ISP charges a lot for the over-quota data usage.

With help from Data Usage feature, device will monitor cellular data usage continuously and take actions. If data usage reaches limited quota, device can be set to drop the cellular data connection right away. Otherwise, if secondary SIM card is inserted, device will switch to secondary SIM and establish another cellular data connection with secondary SIM automatically.

If Data Usage feature is enabled, all history of cellular data usage can be viewed at **Status > Statistics & Reports > Cellular Usage** tab.

| 3G/4G Data Usage Profile List <span>Add</span> <span>Delete</span> |             |              |              |                                   |                 |                                     |                                     |                   |                                 |
|--|-------------|--------------|--------------|-----------------------------------|-----------------|-------------------------------------|-------------------------------------|-------------------|---------------------------------|
| ID   | SIM info    | Carrier Name | Cycle Period | Start Date                        | Data Limitation | Connection Restrict                 | Enable                              | Action            |                                 |
| 1  | 3G/4G SIM A | ISP A        | 1 Monthly    | Wed Sep 05 2018 00:00:00 GMT+0200 | 1GB             | <input checked="" type="checkbox"/> | <input checked="" type="checkbox"/> | <span>Edit</span> | <input type="checkbox"/> Select |

### 3G/4G Data Usage

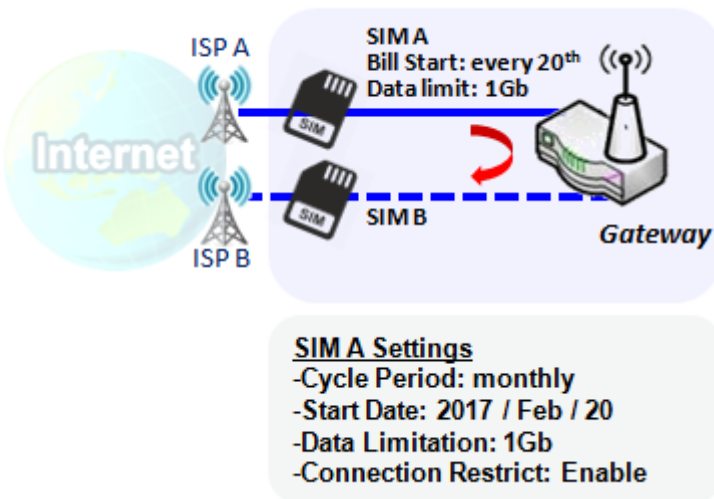

Data Usage feature enabling router device to continuously monitor cellular data usage and take actions. In the diagram, quota limit of SIM A is **1Gb** per month and bill start date is **20<sup>th</sup>** of every month. The device is smart to start a new calculation of data usage on every 20<sup>th</sup> of month. Enable Connection Restrict will force router device to drop cellular connection of SIM A when data usage reaches quota limit (1Gb in this case). If SIM failover feature is configured in **Internet Setup**, then router will switch to SIM B and establish a new cellular data connection automatically.

## Data Usage Setting

Go to **Service > Cellular Toolkit > Data Usage** tab.

Before finished settings for Data Usage, you need to know bill start date, bill period, and quota limit of data usage according to your data plan. You can ask this information from your carrier or ISP.

## Create / Edit 3G/4G Data Usage Profile

| 3G/4G Data Usage Profile List <span>Add</span> <span>Delete</span> |          |              |              |            |                 |                     |        |        |
|--|----------|--------------|--------------|------------|-----------------|---------------------|--------|--------|
| ID   | SIM info | Carrier Name | Cycle Period | Start Date | Data Limitation | Connection Restrict | Enable | Action |

When **Add** button is applied, 3G/4G Data Usage Profile Configuration screen will appear. You can create up to four data usage profiles, one profile for each SIM card used in the Router.

| 3G/4G Data Usage Profile Configuration |  |
|--|--|
| Item                                   | Setting                                    |
| ▶ SIM Select                           | 3G/4G ▾ SIM A ▾                            |
| ▶ Carrier Name                         | <input type="text"/>                       |
| ▶ Cycle Period                         | Days ▾ <input type="text"/>                |
| ▶ Start Date                           | 2018 ▾ / September ▾ / 5 ▾                 |
| ▶ Data Limitation                      | <input type="text"/> KB ▾                  |
| ▶ Connection Restrict                  | <input type="checkbox"/> Enable            |
| ▶ Enable                               | <input checked="" type="checkbox"/> Enable |

### 3G/4G Data Usage Profile Configuration

| Item Setting           | Value setting                 | Description   |
|------------------------|-------------------------------|---|
| <b>SIM Select</b>      | 3G/4G-1 and SIM A by default. | Choose a cellular interface ( <b>3G/4G-1</b> or <b>3G/4G-2</b> ), and a SIM card bound to the selected cellular interface to configure its data usage profile.  |
| <b>Carrier Name</b>    | It is an optional item.       | Fill in the Carrier Name for the selected SIM card for identification.  |
| <b>Cycle Period</b>    | Days by default               | The first box has three types for cycle period. They are <b>Days</b> , <b>Weekly</b> and <b>Monthly</b> .<br><b>Days:</b> For per Days cycle periods, you have to further specify the number of days in the second box.<br><b>Value Range:</b> 1 ~ 90 days.<br><b>Weekly, Monthly:</b> The cycle period is one week or one month. |
| <b>Start Date</b>      | N/A                           | Specify the date to start measure network traffic.<br>Please don't select the day before now, otherwise, the traffic statistics will be incorrect.  |
| <b>Data Limitation</b> | N/A                           | Specify the allowable data limitation for the defined cycle period.   |

|                            |                        |   |
|----------------------------|------------------------|---|
| <b>Connection Restrict</b> | Un-Checked by default. | Check the <b>Enable</b> box to activate the connection restriction function. During the specified cycle period, if the actual data usage exceeds the allowable data limitation, the cellular connection will be forced to disconnect. |
| <b>Enable</b>              | Un-Checked by default. | Check the <b>Enable</b> box to activate the data usage profile.   |

## 6.1.2 SMS

Short Message Service (SMS) is a text messaging service, which is used to be widely-used on mobile phones. It uses standardized communications protocols to allow mobile phones or cellular devices to exchange short text messages in an instant and convenient way.

### SMS Setting

Go to **Service > Cellular Toolkit > SMS** tab

With this router device, you can send SMS text messages or browse received SMS messages as you usually do on a cellular phone.

### Setup SMS Configuration

| Configuration        |  |
|----------------------|--|
| Item                 | Setting  |
| ▶ Physical Interface | 3G/4G-1 ▼  |
| ▶ SMS                | <input checked="" type="checkbox"/> Enable SIM Status: SIM_A                       |
| ▶ SMS Storage        | SIM Card Only ▼  |
| ▶ SMS Space          | <input type="checkbox"/> Enable & Keep Available Space <input type="text"/> (1-10) |

| Configuration             |                                     |  |
|---------------------------|-------------------------------------|--|
| Item                      | Value setting                       | Description  |
| <b>Physical Interface</b> | The box is 3G/4G-1 by default       | Choose a cellular interface ( <b>3G/4G-1</b> or <b>3G/4G-2</b> ) for the following SMS function configuration.               |
| <b>SMS</b>                | The box is checked by default       | This is the SMS switch. If the box checked that the SMS function enable, if the box unchecked that the SMS function disable. |
| <b>SIM Status</b>         | N/A                                 | Depend on currently SIM status. The possible value will be <b>SIM_A</b> or <b>SIM_B</b> .                                    |
| <b>SMS Storage</b>        | The box is SIM Card Only by default | This is the SMS storage location. Currently the option only <b>SIM Card Only</b> .   |
| <b>SMS Space</b>          | The box is unchecked by default     | Settings to keep SMS available space.<br>Value Range: 1 ~ 10   |
| <b>Save</b>               | N/A                                 | Click the <b>Save</b> button to save the settings  |

## SMS Summary

Show **Unread SMS**, **Received SMS**, **Remaining SMS**, and edit SMS context to send, read SMS from SIM card.

| <input type="checkbox"/> SMS Summary <input type="button" value="New SMS"/> <input type="button" value="SMS Inbox"/> <input type="button" value="SMS Sent Folder"/> |         |
|---|---------|
| Item  | Setting |
| ▶ Unread SMS  | 0       |
| ▶ Received SMS  | 5       |
| ▶ Sent SMS  | 0       |
| ▶ Remaining SMS   | 9       |

| SMS Summary            |               |  |
|------------------------|---------------|--|
| Item                   | Value setting | Description  |
| <b>Unread SMS</b>      | N/A           | If SIM card insert to router first time, unread SMS value is zero. When received the new SMS but didn't read, this value plus one.   |
| <b>Received SMS</b>    | N/A           | This value record the existing SMS numbers from SIM card. When received the new SMS, this value plus one.  |
| <b>Sent SMS</b>        | N/A           | This value record the sent SMS numbers from SIM card. When sent the new SMS, this value plus one.  |
| <b>Remaining SMS</b>   | N/A           | This value is SMS capacity minus received SMS, When received the new SMS, this value minus one.  |
| <b>New SMS</b>         | N/A           | Click <b>New SMS</b> button, a <b>New SMS</b> screen appears. User can set the SMS setting from this screen. Refer to New SMS in the next page.  |
| <b>SMS Inbox</b>       | N/A           | Click <b>SMS Inbox</b> button, a <b>SMS Inbox List</b> screen appears. User can read or delete SMS, reply SMS or forward SMS from this screen. Refer to SMS Inbox List in the next page. |
| <b>SMS Sent Folder</b> | N/A           | Folder with list of sent SMS.  |
| <b>Refresh</b>         | N/A           | Click the <b>Refresh</b> button to update the SMS summary immediately.   |

## New SMS

You can set the SMS setting from this screen.

☐ New SMS
Send

| Item           | Setting  |
|----------------|--|
| ▶ Receivers    | <input style="width: 90%;" type="text"/><br>(Use '+' for International Format and ';' to Compose Multiple Receivers)                                 |
| ▶ Text Message | <div style="border: 1px solid #ccc; height: 100px; width: 90%;"></div> <p style="font-size: small; margin-top: 5px;">Length of Current Input : 0</p> |
| ▶ Result       |  |

| New SMS      |               |   |
|--------------|---------------|---|
| Item         | Value setting | Description   |
| Receivers    | N/A           | Write the receivers to send SMS. User need to add the semicolon and compose multiple receivers that can group send SMS. |
| Text Message | N/A           | Write the SMS context to send SMS. The router supports up to a maximum of 1023 character for SMS context length.        |
| Send         | N/A           | Click the <b>Send</b> button, above text message will be sent as a SMS.   |
| Result       | N/A           | If SMS has been sent successfully, it will show <b>Send OK</b> , otherwise <b>Send Failed</b> will be displayed.        |

## SMS Inbox List

You can read or delete SMS, reply SMS or forward SMS from this screen.

☐ SMS Inbox List
Refresh
Delete
Close

| ID | From Phone Number | Timestamp | SMS Text Preview | Actions |
|----|-------------------|-----------|------------------|---------|
|    |                   |           |                  |         |
|    |                   |           |                  |         |
|    |                   |           |                  |         |

| SMS Inbox List    |               |                                |
|-------------------|---------------|--------------------------------|
| Item              | Value setting | Description                    |
| ID                | N/A           | The number or SMS.             |
| From Phone Number | N/A           | What the phone number from SMS |

|                         |                                 |  |
|-------------------------|---------------------------------|--|
| <b>Timestamp</b>        | N/A                             | What time receive SMS  |
| <b>SMS Text Preview</b> | N/A                             | Preview the SMS text. Click the <b>Detail</b> button to read a certain message.  |
| <b>Action</b>           | The box is unchecked by default | Click the <b>Detail</b> button to read the SMS detail; Click the <b>Reply / Forward</b> button to reply/forward SMS.<br>Besides, you can check the box(-es), and then click the <b>Delete</b> button to delete the checked SMS(s). |
| <b>Refresh</b>          | N/A                             | Refresh the SMS Inbox List.  |
| <b>Delete</b>           | N/A                             | Delete the SMS for all checked box from Action.  |
| <b>Close</b>            | N/A                             | Close the Detail SMS Message screen.   |

### 6.1.3 SIM PIN

With most cases in the world, users need to insert a SIM card (a.k.a. UICC) into end devices to get on cellular network for voice service or data surfing. The SIM card is usually released by mobile operators or service providers. Each SIM card has a unique number (so-called ICCID) for network owners or service providers to identify each subscriber. As SIM card plays an important role between service providers and subscribers, some security mechanisms are required on SIM card to prevent any unauthorized access.

Enabling a PIN code in SIM card is an easy and effective way of protecting cellular devices from unauthorized access. This router device allows you to activate and manage PIN code on a SIM card through its web GUI.

#### Activate PIN code on SIM Card

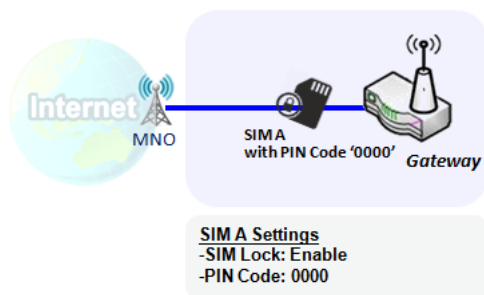

This gateway device allows you to activate PIN code on SIM card. This example shows how to activate PIN code on SIM-A for 3G/4G-1 with default PIN code “0000”.

#### Change PIN code on SIM Card

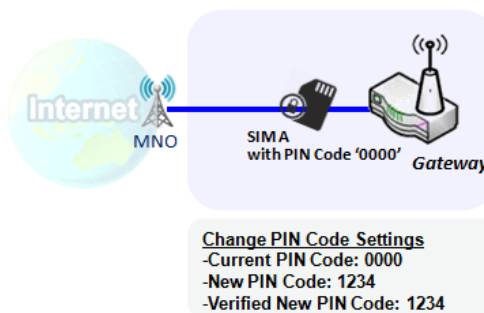

This gateway device allows you to change PIN code on SIM card. Following the example above, you need to type original PIN code “0000”, and then type new PIN code with ‘1234’ if you like to set new PIN code as ‘1234’. To confirm the new PIN code you type is what you want, you need to type new PIN code ‘1234’ in Verified New PIN Code again.

## Unlock SIM card by PUK Code

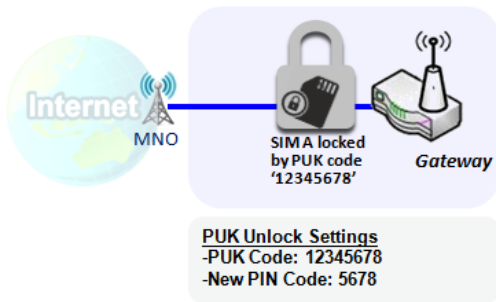

If you entered incorrect PIN code at configuration page for 3G/4G-1 WAN over three times, and then it will cause SIM card to be locked by PUK code. Then you have to call service number to get a PUK code to unlock SIM card. In the diagram, the PUK code is “12345678” and new PIN code is “5678”.

## SIM PIN Setting

Go to **Service > Cellular Toolkit > SIM PIN Tab**

With the SIM PIN Function window, it allows you to enable or disable SIM lock (which means protected by PIN code), or change PIN code. You can also see the information of remaining times of failure trials as we mentioned earlier. If you run out of these failure trials, you need to get a PUK code to unlock SIM card.

## Select a SIM Card

| Configuration      |   |
|--------------------|---|
| Item               | Setting                                     |
| Physical Interface | 3G/4G-1                                     |
| SIM Status         | SIM-A Ready                                 |
| SIM Selection      | SIM-A <input type="button" value="Switch"/> |

| Configuration Window |                               |   |
|----------------------|-------------------------------|---|
| Item                 | Value setting                 | Description   |
| Physical Interface   | The box is 3G/4G-1 by default | Choose a cellular interface ( <b>3G/4G-1</b> or <b>3G/4G-2</b> ) to change the SIM PIN setting for the selected SIM Card.<br>The number of physical modems depends on the gateway model you purchased.  |
| SIM Status           | N/A                           | Indication for the selected SIM card and the SIM card status.<br>The status could be <b>Ready</b> , <b>Not Insert</b> , or <b>SIM PIN</b> .<br><b>Ready</b> -- SIM card is inserted and ready to use. It can be a SIM card without PIN protection or that SIM card is already unlocked by correct PIN code.<br><b>Not Insert</b> -- No SIM card is inserted in that SIM slot.<br><b>SIM PIN</b> -- SIM card is protected by PIN code, and it's not unlocked by a correct PIN code yet. That SIM card is still at locked status. |
| SIM Selection        | N/A                           | Select the SIM card for further SIM PIN configuration.<br>Press the <b>Switch</b> button, then the Router will switch SIM card to another one. After that, you can configure the SIM card.  |



### Enable / Change PIN Code

Enable or Disable PIN code (password) function, and even change PIN code function.

SIM function       

| Item              | Setting   |
|-------------------|---|
| ▶ SIM lock        | <input type="checkbox"/> Enable PIN Code: <input type="text"/> (4~8 digits) |
| ▶ Remaining times | 3   |

| SIM function Window |                    |   |
|---------------------|--------------------|---|
| Item Setting        | Value setting      | Description   |
| SIM lock            | Depend on SIM card | Click the <b>Enable</b> button to activate the SIM lock function. For the first time you want to enable the SIM lock function, you have to fill in the PIN code as well, and then click <b>Save</b> button to apply the setting.  |
| Remaining times     | Depend on SIM card | Represent the remaining trial times for the SIM PIN unlocking.  |
| Save                | N/A                | Click the <b>Save</b> button to apply the setting.  |
| Change PIN Code     | N/A                | Click the <b>Change PIN code</b> button to change the PIN code (password). If the <b>SIM Lock</b> function is not enabled, the <b>Change PIN code</b> button is disabled. In the case, if you still want to change the PIN code, you have to enable the SIM Lock function first, fill in the PIN code, and then click the <b>Save</b> button to enable. After that, You can click the <b>Change PIN code</b> button to change the PIN code. |

When **Change PIN Code** button is clicked, the following screen will appear.

| Item                    | Setting                           |
|-------------------------|-----------------------------------|
| ▶ Current PIN Code      | <input type="text"/> (4~8 digits) |
| ▶ New PIN Code          | <input type="text"/> (4~8 digits) |
| ▶ Verified New PIN Code | <input type="text"/> (4~8 digits) |

| Change PIN Window     |                       |   |
|-----------------------|-----------------------|---|
| Item                  | Value Setting         | Description   |
| Current PIN Code      | A Must filled setting | Fill in the current (old) PIN code of the SIM card.                               |
| New PIN Code          | A Must filled setting | Fill in the new PIN Code you want to change.                                      |
| Verified New PIN Code | A Must filled setting | Confirm the new PIN Code again.   |
| Apply                 | N/A                   | Click the <b>Apply</b> button to change the PIN code with specified new PIN code. |
| Cancel                | N/A                   | Click the <b>Cancel</b> button to cancel the changes and keep current PIN code.   |

**Note:** If you changed the PIN code for a certain SIM card, you must also change the corresponding PIN code specified in the **Basic Network > WAN & Uplink > Internet Setup > Connection with SIM Card** page. Otherwise, it may result in wrong SIM PIN trials with invalid (old) PIN code.

## Unlock with a PUK Code

The PUK Function window is only available for configuration if that SIM card is locked by PUK code. It means that SIM card is locked and needs additional PUK code to unlock. Usually it happens after too many trials of incorrect PIN code, and the remaining times in SIM Function table turns to 0. In this situation, you need to contact your service provider and request a PUK code for your SIM card, and try to unlock the locked SIM card with the provided PUK code. After unlocking a SIM card by PUK code successfully, the SIM lock function will be activated automatically.

| <input type="checkbox"/> PUK function <input type="button" value="Save"/> |                                   |
|---|-----------------------------------|
| Item  | Setting                           |
| ▶ PUK status  | PUK unlock.                       |
| ▶ Remaining times   | 10                                |
| ▶ PUK Code  | <input type="text"/> (8 digits)   |
| ▶ New PIN Code  | <input type="text"/> (4~8 digits) |

| PUK Function Window |                       |   |
|---------------------|-----------------------|---|
| Item                | Value setting         | Description   |
| PUK status          | PUK Unlock / PUK Lock | Indication for the PUK status.<br>The status could be <b>PUK Lock</b> or <b>PUK Unlock</b> . As mentioned earlier, the SIM card will be locked by PUK code after too many trials of failure PIN code. In this case, the PUK Status will turns to <b>PUK Lock</b> . In a normal situation, it will display <b>PUK Unlock</b> . |
| Remaining times     | Depend on SIM card    | Represent the remaining trial times for the PUK unlocking.<br>Note : <b>DO NOT make the remaining times down to zero, it will damage the SIM card FOREVER !</b> Call for your ISP's help to get a correct PUK and unlock the SIM if you don't have the PUK code.  |
| PUK Code            | A Must filled setting | Fill in the PUK code (8 digits) that can unlock the SIM card in PUK unlock status.  |
| New PIN Code        | A Must filled setting | Fill in the New PIN Code (4~8 digits) for the SIM card.<br>You have to determine your new PIN code to replace the old, forgotten one.<br>Keep the PIN code (password) in mind with care.  |
| Save                | N/A                   | Click the <b>Save</b> button to apply the setting.  |

**Note:** If you changed the PUK code and PIN code for a certain SIM card, you must also change the corresponding PIN code specified in the **Basic Network > WAN & Uplink > Internet Setup > Connection with SIM Card** page. Otherwise, it may result in wrong SIM PIN trials with invalid (old) PIN code.

### 6.1.4 Network Scan

"Network Scan" function can let administrator specify the device how to connect to the mobile system for data communication in each 3G/4G interface. For example, administrator can specify which generation of mobile system is used for connection, 2G, 3G or LTE. Moreover, he can define their connection sequence for the router device to connect to the mobile system automatically. Administrator also can scan the mobile systems in the air manually, select the target operator system and apply it. The manual scanning approach is used for problem diagnosis.

#### Network Scan Setting

Go to **Service > Cellular Toolkit > Network Scan** tab.

In "Network Scan" page, there are two windows for the Network Scan function. The "Configuration" window can let you select which 3G/4G module (physical interface) is used to perform Network Scan, and system will show the current used SIM card in the module. You can configure each 3G/4G WAN interface by executing the network scanning one after another. You can also specify the connection sequence of the targeted generation of mobile system, 2G/3G/LTE.

#### Network Scan Configuration

| Configuration        |                             |
|----------------------|-----------------------------|
| Item                 | Setting                     |
| ▶ Physical Interface | 3G/4G-1 ▼ SIM Status: SIM_A |
| ▶ Network Type       | Auto ▼                      |
| ▶ Scan Approach      | Auto ▼                      |

| Configuration      |                               |   |
|--------------------|-------------------------------|---|
| Item               | Value setting                 | Description   |
| Physical Interface | The box is 3G/4G-1 by default | Choose a cellular interface (3G/4G-1 or 3G/4G-2) for the network scan function.<br><b>Note:</b> 3G/4G-2 is only available for the product with dual cellular module.  |
| SIM Status         | N/A                           | Show the connected cellular service (identified with SIM_A or SIM_B).   |
| Network Type       | Auto is selected by default.  | Specify the network type for the network scan function.<br>It can be Auto, 2G Only, 2G prefer, 3G Only, 3G prefer, or LTE Only.<br>When <b>Auto</b> is selected, the network will be register automatically;<br>If the <b>prefer</b> option is selected, network will be register for your option first;<br>If the <b>only</b> option is selected, network will be register for your option only. |
| Scan Approach      | Auto is selected by default.  | When <b>Auto</b> selected, cellular module register automatically.<br>If the <b>Manually</b> option is selected, a <b>Network Provider List</b> screen appears.<br>Press <b>Scan</b> button to scan for the nearest base stations. Select (check the box) the preferred base stations then click <b>Apply</b> button to apply settings.   |
| Save               | N/A                           | Click <b>Save</b> to save the settings  |

The second window is the "Network Provider List" window and it appears when the **Manually** Scan Approach is selected in the Configuration window. By clicking on the "Scan" button and wait for 1 to 3 minutes, the found mobile operator system will be displayed for you to choose. Click again on the "Apply" button to drive system to connect to that mobile operator system for the dedicated 3G/4G interface.

| <input type="checkbox"/> Network Provider List <input type="button" value="Scan"/> <input type="button" value="Apply"/> |               |                |        |
|---|---------------|----------------|--------|
| Provider Name   | Mobile System | Network Status | Action |
|   |               |                |        |

## 6.2 Event Handling

Event handling is the application that allows administrator to setup the pre-defined events, handlers, or response behavior with individual profiles. With properly configuring the event handling function, administrator can easily and remotely obtain the status and information via the purchased router.

The supported events are categorized into two groups: the **managing events** and **notifying events**.

The **managing events** are the events that are used to manage the router or change the setting / status of the specific functionality of the router. On receiving the managing event, the router will take action to change the functionality, and collect the required status for administration simultaneously.

The **notifying events** are the events that some related objects have been triggered and take corresponding actions on the occurrence of the events. It could be an event for alerting the administrator something happened with SMS message, Email, and SNMP Trap, etc...

For ease of configuration, administrator can create and edit the common pre-defined managing / notifying event profiles for taking instant reaction on a certain event or managing the devices for some advanced useful purposes. For example, sending/receiving remote managing SMS for the router's routine maintaining, and so on. All of such management and notification function can be realized effectively via the Event Handling feature.

The following is the summary lists for the provided profiles, and events:

- Profiles (Rules):
  - SMS Configuration and Accounts
  - Email Accounts
- Managing Events:
  - Trigger Type: SMS, SNMP Trap
  - Actions: Get the Network Status; or Configure the LAN/VLAN behavior, WIFI behavior, NAT behavior, Firewall behavior, VPN behavior, System Management, Administration.
- Notifying Events:
  - Trigger Type: Connection Change (WAN, LAN & VLAN, WiFi, DDNS), Administration, and Data Usage.
  - Actions: Notify the administrator with SMS, Syslog, SNMP Trap or Email Alert.

To use the event handling function, First of all, you have to enable the event management setting and configure the event details with the provided profile settings. You can create or edit pre-defined profiles for individual managing / notifying events. The profile settings are separated into several items; they are the SMS Account Definition, and Email Service Definition. Then, you have to configure each managing / notifying event with identifying the event's trigger condition, and the corresponding actions (reaction for the event) for the event. For each event, more than one action can be activated simultaneously.

## 6.2.1 Configuration

Go to **Service > Event Handling > Configuration** Tab.

Event handling is the service that allows administrator to setup the pre-defined events, handlers, or response behavior with individual profiles.

### Enable Event Management

| Configuration      |                                 |
|--------------------|---------------------------------|
| Item               | Setting                         |
| ▶ Event Management | <input type="checkbox"/> Enable |

| Configuration    |                                 |  |
|------------------|---------------------------------|--|
| Item             | Value setting                   | Description  |
| Event Management | The box is unchecked by default | Check the <b>Enable</b> box to activate the Event Management function. |

### Enable SMS Management

To use the SMS management function, you have to configure some important settings first.

| SMS Configuration                     |  |
|---------------------------------------|--|
| Item                                  | Setting  |
| ▶ Message Prefix                      | <input type="checkbox"/> Enable & <input type="text"/> |
| ▶ Physical Interface                  | 3G/4G-1 ▾ SIM Status: SIM_A                            |
| ▶ Delete Managed SMS after Processing | <input type="checkbox"/> Enable                        |

| SMS Configuration                   |                                 |  |
|-------------------------------------|---------------------------------|--|
| Item                                | Value setting                   | Description  |
| Message Prefix                      | The box is unchecked by default | Click the <b>Enable</b> box to enable the SMS prefix for validating the received SMS. Once the function is enabled, you have to enter the prefix behind the checkbox. The received managing events SMS must have the designated prefix as an initial identifier, then corresponding handlers will become effective for further processing. |
| Physical Interface                  | The box is 3G/4G-1 by default.  | Choose a cellular interface ( <b>3G/4G-1</b> or <b>3G/4G-2</b> ) to configure the SMS management setting.<br><b>Note:</b> <b>3G/4G-2</b> is only available for the product with dual cellular module.  |
| SIM Status                          | N/A                             | Show the connected cellular service (identified with <b>SIM_A</b> or <b>SIM_B</b> ).   |
| Delete Managed SMS after Processing | The box is unchecked by default | Check the <b>Enable</b> box to delete the received managing event SMS after it has been processed.   |

## Create / Edit SMS Account

Setup the SMS Account for managing the router through the SMS. It supports up to a maximum of 5 accounts.

| SMS Account List <input type="button" value="Add"/> <input type="button" value="Delete"/> |              |                   |             |                    |        |         |
|---|--------------|-------------------|-------------|--------------------|--------|---------|
| ID  | Phone Number | Phone Description | Application | Send confirmed SMS | Enable | Actions |

You can click the **Add / Edit** button to configure the SMS account.

| SMS Account Configuration           |   |
|-------------------------------------|---|
| Item                                | Setting   |
| ▶ Phone Number                      | Specific Number ▼ <input type="text"/>  |
| ▶ Phone Description                 | <input type="text"/>  |
| ▶ Application                       | <input type="checkbox"/> Event Trigger <input type="checkbox"/> Notify Handle |
| ▶ Send confirmed SMS                | <input type="checkbox"/> Enable   |
| ▶ Enable                            | <input checked="" type="checkbox"/> Enable                                    |
| <input type="button" value="Save"/> |   |

| SMS Account Configuration |   |   |
|---------------------------|---|---|
| Item                      | Value setting   | Description   |
| <b>Phone Number</b>       | 1. Mobile phone number format<br>2. A Must filled setting     | Select the Phone number policy from the drop list, and specify a mobile phone number as the SMS account identifier if required.<br>It can be <b>Specific Number</b> , or <b>Allow Any</b> . If <b>Specific Number</b> is selected, you have to specify the phone number as the SMS account identifier.<br><b>Value Range: -1 ~ 32 digits.</b> |
| <b>Phone Description</b>  | 1. Any text<br>2. An Optional setting                         | Specify a brief description for the SMS account.  |
| <b>Application</b>        | A Must filled setting   | Specify the application type. It could be <b>Event Trigger</b> , <b>Notify Handle</b> , or <b>both</b> .<br>If the Phone Number policy is <b>Allow Any</b> , the Notify Handle will be unavailable.   |
| <b>Send confirmed SMS</b> | 1. An Optional setting<br>2. The box is unchecked by default. | Click <b>Enable</b> box to active the SMS response function.<br>The router will send a confirmed message back to the sender whenever it received a SMS managing event. The confirmed message is similar to following format: <i>"Device received a SMS with command xxxxx."</i>   |
| <b>Enable</b>             | The box is unchecked by default.                              | Click <b>Enable</b> box to activate this account.   |
| <b>Save</b>               | NA  | Click the <b>Save</b> button to save the configuration.   |

### Create / Edit Email Service Account

Setup the Email Service Account for event notification. It supports up to a maximum of 5 accounts.

| <input type="checkbox"/> Email Service List <input type="button" value="Add"/> <input type="button" value="Delete"/> |              |                 |        |         |
|--|--------------|-----------------|--------|---------|
| ID   | Email Server | Email Addresses | Enable | Actions |

You can click the **Add / Edit** button to configure the Email account.

| <input type="checkbox"/> Email Service Configuration |  |
|--|--|
| Item   | Setting                                    |
| ▶ Email Server                                       | --- Option --- ▾                           |
| ▶ Email Addresses                                    | <input type="text"/>                       |
| ▶ Enable   | <input checked="" type="checkbox"/> Enable |
| <input type="button" value="Save"/>                  |  |

| Email Service Configuration |   |   |
|-----------------------------|---|---|
| Item                        | Value setting   | Description   |
| Email Server                | --- Option ---  | Select an Email Server profile from <b>External Server</b> setting for the email account setting. |
| Email Addresses             | 1. Internet E-mail address format<br>2. A Must filled setting | Specify the Destination Email Addresses.  |
| Enable                      | The box is unchecked by default.                              | Click <b>Enable</b> box to activate this account.   |
| Save                        | NA  | Click the <b>Save</b> button to save the configuration  |



## Create / Edit Remote Host

Setup the Remote Host for managing the router through the remote host. It supports up to a maximum of 5 accounts.

| Remote Host List <input type="button" value="Add"/> <input type="button" value="Delete"/> |           |         |               |             |                |                |        |         |
|---|-----------|---------|---------------|-------------|----------------|----------------|--------|---------|
| ID  | Host Name | Host IP | Protocol Type | Port Number | Prefix Message | Suffix Message | Enable | Actions |

You can click the **Add / Edit** button to configure the host account.

| Remote Host Configuration           |                          |
|-------------------------------------|--------------------------|
| Item                                | Setting                  |
| ▶ Host Name                         | <input type="text"/>     |
| ▶ Host IP                           | <input type="text"/>     |
| ▶ Protocol Type                     | TCP ▼                    |
| ▶ Port Number                       | <input type="text"/>     |
| ▶ Prefix Message                    | <input type="text"/>     |
| ▶ Suffix Message                    | <input type="text"/>     |
| ▶ Enable                            | <input type="checkbox"/> |
| <input type="button" value="Save"/> |                          |

| Remote Host Configuration |  |  |
|---------------------------|--|--|
| Item                      | Value setting  | Description  |
| <b>Host Name</b>          | String format: any text.<br>2. A Must filled setting | Specify the name of the host.                          |
| <b>Host IP</b>            | 1. IP address<br>2. A Must filled setting            | Specify the host IP address.                           |
| <b>Protocol Type</b>      | 1. TCP/UDP<br>2. A Must filled setting               | Select type of protocol, TCP or UDP.                   |
| <b>Port Number</b>        | 1. Port number<br>2. A Must filled setting           | Specify TCP/UDP port number.                           |
| <b>Prefix Message</b>     | String format: any text.                             | Enter message prefix.                                  |
| <b>Suffix Message</b>     | String format: any text.                             | Enter message suffix.                                  |
| <b>Enable</b>             | The box is unchecked by default.                     | Click <b>Enable</b> box to activate this account.      |
| <b>Save</b>               | NA   | Click the <b>Save</b> button to save the configuration |

### 6.2.2 Managing Events

Managing Events allow administrator to define the relationship (rule) among event trigger, handlers and response.

Go to **Service > Event Handling > Managing Events** Tab.

#### Enable Managing Events

| Configuration     |                                 |
|-------------------|---------------------------------|
| Item              | Setting                         |
| ▶ Managing Events | <input type="checkbox"/> Enable |

| Configuration   |                                 |   |
|-----------------|---------------------------------|---|
| Item            | Value setting                   | Description   |
| Managing Events | The box is unchecked by default | Check the <b>Enable</b> box to activate the Managing Events function. |

### Create / Edit Managing Event Rules

Setup the Managing Event rules. It supports up to a maximum of 128 rules.

| <input type="checkbox"/> Managing Event List <input type="button" value="Add"/> <input type="button" value="Delete"/> |       |              |             |        |         |
|---|-------|--------------|-------------|--------|---------|
| ID  | Event | Trigger Type | Description | Enable | Actions |

When **Add** or **Edit** button is applied, the **Managing Event Configuration** screen will appear.

| <input type="checkbox"/> Managing Event Configuration |   |
|---|---|
| Item  | Setting   |
| ▶ Event   | None ▼<br>None ▼<br>None ▼  |
| ▶ Trigger Type  | Period ▼  |
| ▶ Interval  | 0 (0~86400 seconds)   |
| ▶ Description   | <input type="text"/>  |
| ▶ Action  | <input type="checkbox"/> Network Status<br><input type="checkbox"/> WAN<br><input type="checkbox"/> LAN&VLAN<br><input type="checkbox"/> WiFi<br><input type="checkbox"/> NAT<br><input type="checkbox"/> Firewall<br><input type="checkbox"/> VPN<br><input type="checkbox"/> GRE<br><input type="checkbox"/> System Manage<br><input type="checkbox"/> Administration<br><input type="checkbox"/> Remote Host |
| ▶ Managing Event                                      | <input checked="" type="checkbox"/> Enable  |
| <input type="button" value="Save"/>                   |   |

| Managing Event Configuration |                                  |  |
|------------------------------|----------------------------------|--|
| Item                         | Value setting                    | Description  |
| <b>Event</b>                 | SMS (or SNMP Trap) by default    | Specify the Event type ( <b>SMS</b> , <b>SNMP Trap</b> ) and an event identifier / profile.<br><b>SMS</b> : Select <b>SMS</b> and fill the message in the textbox to as the trigger condition for the event;<br><b>SNMP</b> : Select <b>SNMP Trap</b> and fill the message in the textbox to specify SNMP Trap Event;<br><br><i>Note: The available Event Type could be different for the purchased product.</i>   |
| <b>Trigger Type</b>          | Period (or Once) by default      | Specify the Trigger Type ( <b>Period</b> , <b>Once</b> ).<br><b>Period</b> : Event will be executed in a period set by Interval below.<br><b>Once</b> : Event will be executed just once.  |
| <b>Interval</b>              | Number in seconds                | Time interval for event execution in period.<br>Interval: 0 ~ 86400<br><br><i>Note: Available for Trigger Type set to Period only.</i>   |
| <b>Description</b>           | String format: any text.         | Enter a brief description for the Managing Event.  |
| <b>Action</b>                | All box is unchecked by default. | Specify <b>Network Status</b> , or at least one rest action to take when the expected event is triggered.<br><b>Network Status</b> : Select Network Status Checkbox to get the network status as the action for the event;<br><b>WAN</b> : Select <b>WAN</b> checkbox and the interested sub-items (Connect/Disconnect, Auto/LTE/3G/2G), the router will change the settings as the action for the event;<br><b>LAN&amp;VLAN</b> : Select <b>LAN&amp;VLAN</b> Checkbox and the interested sub-items (Port link On/Off), the router will change the settings as the action for the event;<br><b>WiFi</b> : Select <b>WiFi</b> Checkbox and the interested sub-items (WiFi radio On/Off), the router will change the settings as the action for the event;<br><b>NAT</b> : Select <b>NAT</b> Checkbox and the interested sub-items (Virtual Server Rule On/Off, DMZ On/Off), the router will change the settings as the action for the event;<br><b>Firewall</b> : Select <b>Firewall</b> Checkbox and the interested sub-items (Remote Administrator Host ID On/Off), the router will change the settings as the action for the event;<br><b>VPN</b> : Select <b>VPN</b> Checkbox and the interested sub-items (IPSec Tunnel ON/Off, PPTP Client On/Off, L2TP Client On/Off, OpenVPN Client On/Off), the router will change the settings as the action for the event;<br><b>GRE</b> : Select <b>GRE</b> Checkbox and the interested sub-items (GRE Tunnel On/Off), the router will change the settings as the action for the event;<br><b>System Manage</b> : Select <b>System Manage</b> Checkbox and the interested sub-items (WAN SSH Service On/Off, TR-069 On/Off), the router will change the settings as the action for the event;<br><b>Administration</b> : Select <b>Administration</b> Checkbox and the interested sub-items (Backup Config, Restore Config, Reboot, Save Current Setting as Default), the router will change the settings as the action for the event;<br><b>Remote Host</b> : Select <b>Remote Host</b> checkbox and one of defined remote hosts.<br><br><i>Note: The available Event Type could be different for the purchased product.</i> |
| <b>Managing Event</b>        | The box is unchecked by default. | Click <b>Enable</b> box to activate this Managing Event setting.   |
| <b>Save</b>                  | NA                               | Click the <b>Save</b> button to save the configuration   |
| <b>Undo</b>                  | NA                               | Click the <b>Undo</b> button to restore what you just configured back to the previous setting.   |

### 6.2.3 Notifying Events

Go to **Service > Event Handling > Notifying Events** Tab.

Notifying Events Setting allows administrator to define the relationship (rule) between event trigger and handlers.

#### Enable Notifying Events

| <input type="checkbox"/> Configuration |  |
|--|--|
| Item                                   | Setting                                    |
| ▶ Notifying Events                     | <input checked="" type="checkbox"/> Enable |

| Configuration    |                                 |  |
|------------------|---------------------------------|--|
| Item             | Value setting                   | Description  |
| Notifying Events | The box is unchecked by default | Check the <b>Enable</b> box to activate the Notifying Events function. |

#### Create / Edit Notifying Event Rules

Setup your Notifying Event rules. It supports up to a maximum of 128 rules.

| <input type="checkbox"/> Notifying Event List <input type="button" value="Add"/> <input type="button" value="Delete"/> |       |              |             |        |               |        |         |
|--|-------|--------------|-------------|--------|---------------|--------|---------|
| ID   | Event | Trigger Type | Description | Action | Time Schedule | Enable | Actions |

When **Add** or **Edit** button is applied, the **Notifying Event Configuration** screen will appear.

▣ Notifying Event Configuration

| Item               | Setting   |
|--------------------|---|
| ▶ Event            | <div style="margin-bottom: 5px;">None ▾</div> <div style="margin-bottom: 5px;">None ▾</div> <div style="margin-bottom: 5px;">None ▾</div>   |
| ▶ Trigger Type     | Period ▾  |
| ▶ Interval         | 0 (0~86400 seconds)   |
| ▶ Description      | <input style="width: 90%;" type="text"/>  |
| ▶ Action           | <input type="checkbox"/> SMS<br><input type="checkbox"/> Syslog<br><input type="checkbox"/> SNMP Trap<br><input type="checkbox"/> Email Alert<br><input type="checkbox"/> Remote Host |
| ▶ Time Schedule    | (0) Always ▾  |
| ▶ Notifying Events | <input checked="" type="checkbox"/> Enable  |

| Notifying Event Configuration |  |  |
|-------------------------------|--|--|
| Item                          | Value setting                              | Description  |
| <b>Event</b>                  | WAN is selected by default                 | Specify the Event type and corresponding event configuration. The supported Event Type could be:<br><b>WAN:</b> Select <b>WAN</b> and a trigger condition to specify a certain WAN Event;<br><b>LAN&amp;VLAN:</b> Select <b>LAN&amp;VLAN</b> and a trigger condition to specify a certain LAN&VLAN Event;<br><b>WiFi:</b> Select <b>WiFi</b> and a trigger condition to specify a certain WiFi Event;<br><b>DDNS:</b> Select <b>DDNS</b> and a trigger condition to specify a certain DDNS Event;<br><b>Administration:</b> Select <b>Administration</b> and a trigger condition to specify a certain Administration Event;<br><b>Data Usage:</b> Select <b>Data Usage</b> , the SIM Card (Cellular Service) and a trigger condition to specify a certain Data Usage Event;<br><br><i>Note: The available Event Type could be different for the purchased product.</i> |
| <b>Trigger Type</b>           | <b>Period</b> (or <b>Once</b> ) by default | Specify the Trigger Type ( <b>Period</b> , <b>Once</b> ).<br><b>Period:</b> Event will be executed in a period set by Interval below.<br><b>Once:</b> Event will be executed just once.  |
| <b>Interval</b>               | Number in seconds                          | Time interval for event execution in period.<br>Interval: 0 ~ 86400<br><br><i>Note: Available for Trigger Type set to Period only.</i>   |
| <b>Description</b>            | String format : any text.                  | Enter a brief description for the Notifying Event.   |
| <b>Action</b>                 | All box is unchecked by default.           | Specify at least one action to take when the expected event is triggered.<br><b>SMS:</b> Select <b>SMS</b> , and the router will send out a SMS to all the defined SMS accounts as the action for the event;   |

|                         |  |   |
|-------------------------|--|---|
|                         |  | <p><b>Syslog:</b> Select <b>Syslog</b> and select/unselect the Enable Checkbox to as the action for the event;</p> <p><b>SNMP Trap:</b> Select <b>SNMP Trap</b>, and the router will send out SNMP Trap to the defined SNMP Event Receivers as the action for the event;</p> <p><b>Email Alert:</b> Select <b>Email Alert</b>, and the router will send out an Email to the defined Email accounts as the action for the event;</p> <p><b>Remote Host:</b> Select <b>Remote Host</b> checkbox and one of defined remote hosts.</p> <p><i>Note: The available Event Type could be different for the purchased product.</i></p> |
| <b>Time Schedule</b>    | <b>(0) Always</b> is selected by default | Select a time scheduling rule for the Notifying Event.  |
| <b>Notifying Events</b> | The box is unchecked by default.         | Click <b>Enable</b> box to activate this Notifying Event setting.   |
| <b>Save</b>             | NA                                       | Click the <b>Save</b> button to save the configuration  |
| <b>Undo</b>             | NA                                       | Click the <b>Undo</b> button to restore what you just configured back to the previous setting.  |

## 7. Status

### 7.1 Basic Network

#### 7.1.1 WAN & Uplink Status

Go to **Status > Basic Network > WAN & Uplink** tab.

The **WAN & Uplink Status** window shows the current status for different network type, including network configuration, connecting information, modem status and traffic statistics. The display will be refreshed on every five seconds.

#### WAN interface IPv4 Network Status

**WAN interface IPv4 Network Status** screen shows status information for IPv4 network.

| ID    | Interface | WAN Type | Network Type | IP Addr.    | Subnet Mask     | Gateway     | DNS                             | MAC Address | Conn. Status               | Action               |
|-------|-----------|----------|--------------|-------------|-----------------|-------------|---------------------------------|-------------|----------------------------|----------------------|
| WAN-1 | 3G/4G     | 3G/4G    | NAT          | 89.24.1.237 | 255.255.255.252 | 89.24.1.238 | 93.153.117.49,<br>93.153.117.17 | N/A         | Connected<br>8 day 1:50:50 | <a href="#">Edit</a> |
| WAN-2 |           | Disable  |              |             |                 |             |                                 |             |                            | <a href="#">Edit</a> |

| WAN interface IPv4 Network Status |               |   |
|-----------------------------------|---------------|---|
| Item                              | Value setting | Description   |
| <b>ID</b>                         | N/A           | It displays corresponding WAN interface WAN IDs.  |
| <b>Interface</b>                  | N/A           | It displays the type of WAN physical interface.<br>Depending on the model purchased, it can be Ethernet, 3G/4G, etc...  |
| <b>WAN Type</b>                   | N/A           | It displays the method which public IP address is obtained from your ISP.<br>Depending on the model purchased, it can be Static IP, Dynamic IP, PPPoE, PPTP, L2TP, 3G/4G. |
| <b>Network Type</b>               | N/A           | It displays the network type for the WAN interface(s).<br>Depending on the model purchased, it can be NAT, Routing, Bridge, or IP Pass-through.                           |
| <b>IP Addr.</b>                   | N/A           | It displays the public IP address obtained from your ISP for Internet connection. Default value is 0.0.0.0 if left unconfigured.  |
| <b>Subnet Mask</b>                | N/A           | It displays the Subnet Mask for public IP address obtained from your ISP for Internet connection. Default value is 0.0.0.0 if left unconfigured.                          |
| <b>Gateway</b>                    | N/A           | It displays the Gateway IP address obtained from your ISP for Internet connection. Default value is 0.0.0.0 if left unconfigured.   |
| <b>DNS</b>                        | N/A           | It displays the IP address of DNS server obtained from your ISP for Internet connection. Default value is 0.0.0.0 if left unconfigured.                                   |
| <b>MAC Address</b>                | N/A           | It displays the MAC Address for your ISP to allow you for Internet access.<br>Note: Not all ISP may require this field.   |



|                     |     |   |
|---------------------|-----|---|
| <b>Conn. Status</b> | N/A | It displays the connection status of the device to your ISP. Status are Connected or disconnected.  |
| <b>Action</b>       | N/A | <p>This area provides functional buttons.</p> <p><b>Renew</b> button allows user to force the device to request an IP address from the DHCP server. Note: <b>Renew</b> button is available when DHCP WAN Type is used and WAN connection is disconnected.</p> <p><b>Release</b> button allows user to force the device to clear its IP address setting to disconnect from DHCP server. Note: <b>Release</b> button is available when DHCP WAN Type is used and WAN connection is connected.</p> <p><b>Connect</b> button allows user to manually connect the device to the Internet. Note: Connect button is available when Connection Control in WAN Type setting is set to Connect Manually (Refer to <b>Edit</b> button in <b>Basic Network &gt; WAN &amp; Uplink &gt; Internet Setup</b>) and WAN connection status is disconnected.</p> <p><b>Disconnect</b> button allows user to manually disconnect the device from the Internet. Note: <b>Connect</b> button is available when Connection Control in WAN Type setting is set to Connect Manually (Refer to <b>Edit</b> button in <b>Basic Network &gt; WAN &amp; Uplink &gt; Internet Setup</b>) and WAN connection status is connected.</p> |

## WAN interface IPv6 Network Status

WAN interface IPv6 Network Status screen shows status information for IPv6 network.

| WAN Interface IPv6 Network Status |           |          |                       |                   |              |                                     |
|-----------------------------------|-----------|----------|-----------------------|-------------------|--------------|-------------------------------------|
| ID                                | Interface | WAN Type | Link-local IP Address | Global IP Address | Conn. Status | Action                              |
| WAN-1                             |           | Disable  |                       |                   |              | <input type="button" value="Edit"/> |

| WAN interface IPv6 Network Status |               |  |
|-----------------------------------|---------------|--|
| Item                              | Value setting | Description  |
| <b>ID</b>                         | N/A           | It displays corresponding WAN interface WAN IDs.   |
| <b>Interface</b>                  | N/A           | It displays the type of WAN physical interface. Depending on the model purchased, it can be Ethernet, 3G/4G, etc...  |
| <b>WAN Type</b>                   | N/A           | It displays the method which public IP address is obtained from your ISP. WAN type setting can be changed from <b>Basic Network &gt; IPv6 &gt; Configuration</b> . |
| <b>Link-local IP Address</b>      | N/A           | It displays the LAN IPv6 Link-Local address.   |
| <b>Global IP Address</b>          | N/A           | It displays the IPv6 global IP address assigned by your ISP for your Internet connection.  |

|                     |     |   |
|---------------------|-----|---|
| <b>Conn. Status</b> | N/A | It displays the connection status. The status can be connected, disconnected and connecting.  |
| <b>Action</b>       | N/A | This area provides functional buttons.<br><b>Edit Button</b> when pressed, web-based utility will take you to the IPv6 configuration page. ( <b>Basic Network &gt; IPv6 &gt; Configuration.</b> ) |

## LAN Interface Network Status

LAN Interface Network Status screen shows IPv4 and IPv6 information of LAN network.

| LAN Interface Network Status |                  |                          |                     |                   |   |
|------------------------------|------------------|--------------------------|---------------------|-------------------|---|
| IPv4 Address                 | IPv4 Subnet Mask | IPv6 Link-local Address  | IPv6 Global Address | MAC Address       | Action  |
| 192.168.1.1                  | 255.255.255.0    | fe80::2d0:c9ff:fe5d:53f1 | /64                 | 00:D0:C9:FD:53:F1 | <input type="button" value="Edit IPv4"/> <input type="button" value="Edit IPv6"/> |

| LAN Interface Network Status   |               |  |
|--------------------------------|---------------|--|
| Item                           | Value setting | Description  |
| <b>IPv4 Address</b>            | N/A           | It displays the current IPv4 IP Address of the gateway<br>This is also the IP Address user use to access Router's Web-based Utility.   |
| <b>IPv4 Subnet Mask</b>        | N/A           | It displays the current mask of the subnet.  |
| <b>IPv6 Link-local Address</b> | N/A           | It displays the current LAN IPv6 Link-Local address.<br>This is also the IPv6 IP Address user use to access Router's Web-based Utility.  |
| <b>IPv6 Global Address</b>     | N/A           | It displays the current IPv6 global IP address assigned by your ISP for your Internet connection.  |
| <b>MAC Address</b>             | N/A           | It displays the LAN MAC Address of the router  |
| <b>Action</b>                  | N/A           | This area provides functional buttons.<br><b>Edit IPv4 Button</b> when press, web-based utility will take you to the Ethernet LAN configuration page. ( <b>Basic Network &gt; LAN &amp; VLAN &gt; Ethernet LAN</b> tab).<br><b>Edit IPv6 Button</b> when press, web-based utility will take you to the IPv6 configuration page. ( <b>Basic Network &gt; IPv6 &gt; Configuration.</b> ) |

## 3G/4G Modem Status

**3G/4G Modem Status List** screen shows status information for 3G/4G WAN network(s).

| 3G/4G Modem Status List <span style="float: right;">Refresh</span> |                  |             |                 |                   |                        |
|--|------------------|-------------|-----------------|-------------------|------------------------|
| Interface  | Card Information | Link Status | Signal Strength | Network Name      | Action                 |
| 3G/4G  | ME3630           | Connected   | N/A             | T-Mobile CZ (LTE) | <a href="#">Detail</a> |

| 3G/4G Modem Status List |               |   |
|-------------------------|---------------|---|
| Item                    | Value setting | Description   |
| Physical Interface      | N/A           | It displays the type of WAN physical interface.<br>Note: Some device model may support two 3G/4G modules. Their physical interface name will be <b>3G/4G-1</b> and <b>3G/4G-2</b> .                                     |
| Card Information        | N/A           | It displays the vendor's 3G/4G modem model name.  |
| Link Status             | N/A           | It displays the 3G/4G connection status. The status can be Connecting, Connected, Disconnecting, and Disconnected.  |
| Signal Strength         | N/A           | It displays the 3G/4G wireless signal level.  |
| Network Name            | N/A           | It displays the name of the service network carrier.  |
| Refresh                 | N/A           | Click the <b>Refresh</b> button to renew the information.   |
| Action                  | N/A           | This area provides functional buttons.<br><b>Detail Button</b> when press, windows of detail information will appear. They are the Modem Information, SIM Status, and Service Information. Refer to next page for more. |

When the **Detail** button is pressed, 3G/4G modem information windows such as Modem Information, SIM Status, Service Information, Signal Strength / Quality, and Error Message will appear.

## Interface Traffic Statistics

**Interface Traffic Statistics** screen displays the Interface's total transmitted packets.

| Interface Traffic Statistics |           |                      |                         |                       |
|------------------------------|-----------|----------------------|-------------------------|-----------------------|
| ID                           | Interface | Received Packets(Mb) | Transmitted Packets(Mb) | Action                |
| WAN-1                        | 3G/4G     | 118.13               | 1276.76                 | <a href="#">Reset</a> |
| WAN-2                        |           | -                    | -                       |                       |

| Interface Traffic Statistics |               |   |
|------------------------------|---------------|---|
| Item                         | Value setting | Description   |
| ID                           | N/A           | It displays corresponding WAN interface WAN IDs.  |
| Interface                    | N/A           | It displays the type of WAN physical interface. Depending on the model purchased, it can be Ethernet, 3G/4G, etc... |
| Received Packets (Mb)        | N/A           | It displays the downstream packets (Mb). It is reset when the device is rebooted.                                   |
| Transmitted Packets (Mb)     | N/A           | It displays the upstream packets (Mb). It is reset when the device is rebooted.                                     |

### 7.1.2 LAN & VLAN Status

Go to **Status > Basic Network > LAN & VLAN** tab.

#### Client List

The **Client List** shows you the LAN Interface, IP address, Host Name, MAC Address, and Remaining Lease Time of each device that is connected to this router.

| LAN Client List |                           |           |                   |                      |
|-----------------|---------------------------|-----------|-------------------|----------------------|
| LAN Interface   | IP Address                | Host Name | MAC Address       | Remaining Lease Time |
| Ethernet        | Dynamic / 192.168.123.222 | TRAPER-NB | D9-4B-50-A6-53-7B | 23:59:02             |

| LAN Client List      |               |   |
|----------------------|---------------|---|
| Item                 | Value setting | Description   |
| LAN Interface        | N/A           | Client record of LAN Interface. String Format.  |
| IP Address           | N/A           | Client record of IP Address Type and the IP Address. Type is String Format and the IP Address is IPv4 Format. |
| Host Name            | N/A           | Client record of Host Name. String Format.  |
| MAC Address          | N/A           | Client record of MAC Address. MAC Address Format.   |
| Remaining Lease Time | N/A           | Client record of Remaining Lease Time. Time Format.   |

### 7.1.3 WiFi Status

Go to **Status > Basic Network > WiFi** tab.

The **WiFi Status** window shows the overall statistics of WiFi VAP entries.

#### WiFi Virtual AP List

The WiFi Virtual AP List shows all of the virtual AP information. The **Edit** button allows for quick configuration changes.

| WiFi Module One Virtual AP List |       |                                     |           |            |         |             |                |                   |  |
|---------------------------------|-------|-------------------------------------|-----------|------------|---------|-------------|----------------|-------------------|--|
| Op. Band                        | ID    | WiFi Enable                         | Op. Mode  | SSID       | Channel | WiFi System | Auth.&Security | MAC Address       | Action                                       |
| 2.4G                            | VAP-1 | <input checked="" type="checkbox"/> | AP Router | Staff_2.4G | 12      | b/g/n Mixed | WPA2-PSK(AES)  | 00:D0:C9:FD:53:F3 | <a href="#">Edit</a> <a href="#">QR Code</a> |
| 2.4G                            | VAP-2 | <input type="checkbox"/>            | AP Router | default    | 12      | b/g/n Mixed | WPA2-PSK(AES)  | 02:D0:C9:FC:53:F3 | <a href="#">Edit</a> <a href="#">QR Code</a> |

| WiFi Virtual AP List |               |   |
|----------------------|---------------|---|
| Item                 | Value setting | Description   |
| Op. Band             | N/A           | It displays the Wi-Fi Operation Band 2.4G of VAP.   |
| ID                   | N/A           | It displays the ID of VAP.  |
| WiFi Enable          | N/A           | It displays whether the VAP wireless signal is enabled or disabled.   |
| Op. Mode             | N/A           | The Wi-Fi Operation Mode of VAP. Depends of device model, modes are AP Router, WDS Only and WDS Hybrid, Universal Repeater and Client.  |
| SSID                 | N/A           | It displays the network ID of VAP.  |
| Channel              | N/A           | It displays the wireless channel used.  |
| WiFi System          | N/A           | The WiFi System of VAP.   |
| Auth. & Security     | N/A           | It displays the authentication and encryption type used.  |
| MAC Address          | N/A           | It displays MAC Address of VAP.   |
| Action               | N/A           | Click the <b>Edit</b> button to make a quick access to the WiFi configuration page. ( <b>Basic Network &gt; WiFi &gt; Configuration</b> tab)<br>The <b>QR Code</b> button allow you to generate QR code for quick connect to the VAP by scanning the QR code. |

### WiFi IDS Status

The WiFi Traffic Statistic shows all the received and transmitted packets on WiFi network.

| WiFi Module One IDS Status |                           |                              |                     |                      |                        |                   |                      |        |
|----------------------------|---------------------------|------------------------------|---------------------|----------------------|------------------------|-------------------|----------------------|--------|
| Authentication Frame       | Association Request Frame | Re-association Request Frame | Probe Request Frame | Disassociation Frame | Deauthentication Frame | EAP Request Frame | Malicious Data Frame | Action |
| 0                          | 0                         | 0                            | 0                   | 0                    | 0                      | 0                 | 0                    | Reset  |

| WiFi IDS Status              |               |   |
|------------------------------|---------------|---|
| Item                         | Value setting | Description   |
| Authentication Frame         | N/A           | It displays the receiving Authentication Frame count.                               |
| Association Request Frame    | N/A           | It displays the receiving Association Request Frame count.                          |
| Re-association Request Frame | N/A           | It displays the receiving Re-association Request Frame count.                       |
| Probe Request Frame          | N/A           | It displays the receiving Probe Request Frame count.                                |
| Disassociation Frame         | N/A           | It displays the receiving Disassociation Frame count.                               |
| Deauthentication Frame       | N/A           | It displays the receiving Deauthentication Frame count.                             |
| EAP Request Frame            | N/A           | It displays the receiving EAP Request Frame count.                                  |
| Malicious Data Frame         | N/A           | It displays the number of receiving unauthorized wireless packets.                  |
| Action                       | N/A           | Click the <b>Reset</b> button to clear the entire statistic and reset counter to 0. |



- Ensure WIDS function is enabled
- Go to Basic Network > WiFi > Advanced Configuration tab

### WiFi Traffic Statistic

The WiFi Traffic Statistic shows all the received and transmitted packets on WiFi network.

| WiFi Module One Traffic Statistics <input type="button" value="Refresh"/> |       |                  |                     |        |
|---|-------|------------------|---------------------|--------|
| Op. Band  | ID    | Received Packets | Transmitted Packets | Action |
| 2.4G  | VAP-1 | 3635             | 3556                | Reset  |
| 2.4G  | VAP-2 | 0                | 0                   | Reset  |

| WiFi Traffic Statistic |               |   |
|------------------------|---------------|---|
| Item                   | Value setting | Description   |
| Op. Band               | N/A           | It displays the Wi-Fi Operation Band 2.4G of VAP.                                     |
| ID                     | N/A           | It displays the VAP ID.   |
| Received Packets       | N/A           | It displays the number of received packets.   |
| Transmitted Packet     | N/A           | It displays the number of transmitted packets.  |
| Action                 | N/A           | Click the <b>Reset</b> button to clear individual VAP statistics.                     |
| Refresh Button         | N/A           | Click the <b>Refresh</b> button to update the entire VAP Traffic Statistic instantly. |

### 7.1.4 DDNS Status

Go to **Status > Basic Network > DDNS** tab.

The **DDNS Status** window shows the current DDNS service in use, the last update status, and the last update time to the DDNS service server.

#### DDNS Status

| DDNS Status List |          |              |                    |                  |
|------------------|----------|--------------|--------------------|------------------|
| Host Name        | Provider | Effective IP | Last Update Status | Last Update Time |

| DDNS Status        |               |   |
|--------------------|---------------|---|
| Item               | Value Setting | Description   |
| Host Name          | N/A           | It displays the name you entered to identify DDNS service provider  |
| Provider           | N/A           | It displays the DDNS server of DDNS service provider  |
| Effective IP       | N/A           | It displays the public IP address of the device updated to the DDNS server  |
| Last Update Status | N/A           | It displays whether the last update of the device public IP address to the DDNS server has been successful (Ok) or failed (Fail). |
| Last Update Time   | N/A           | It displays time stamp of the last update of public IP address to the DDNS server.  |
| Refresh            | N/A           | The <b>refresh</b> button allows user to force the display to refresh information.  |

## 7.2 Security

### 7.2.1 VPN Status

Go to **Status > Security > VPN** tab.

The **VPN Status** widow shows the overall VPN tunnel status. The display will be refreshed on every five seconds.

### IPSec Tunnel Status

**IPSec Tunnel Status** windows show the configuration for establishing IPSec VPN connection and current connection status.

| IPSec Tunnel Status |                 |               |                |                |            |        |
|---------------------|-----------------|---------------|----------------|----------------|------------|--------|
| Tunnel Name         | Tunnel Scenario | Local Subnets | Remote IP/FQDN | Remote Subnets | Conn. Time | Status |

| IPSec Tunnel Status |               |   |
|---------------------|---------------|---|
| Item                | Value setting | Description   |
| Tunnel Name         | N/A           | It displays the tunnel name you have entered to identify.   |
| Tunnel Scenario     | N/A           | It displays the Tunnel Scenario specified.  |
| Local Subnets       | N/A           | It displays the Local Subnets specified.  |
| Remote IP/FQDN      | N/A           | It displays the Remote IP/FQDN specified.   |
| Remote Subnets      | N/A           | It displays the Remote Subnets specified.   |
| Conn. Time          | N/A           | It displays the connection time for the IPSec tunnel.   |
| Status              | N/A           | It displays the Status of the VPN connection. The status displays are Connected, Disconnected, Wait for traffic, and Connecting.                          |
| Edit Button         | N/A           | Click on Edit Button to change IPSec setting, web-based utility will take you to the IPSec configuration page. ( <b>Security &gt; VPN &gt; IPSec</b> tab) |



## OpenVPN Client Status

| OpenVPN Client Name | Interface | Remote IP/FQDN | Remote Subnet | TUN/TAP Read(bytes) | TUN/TAP Write(bytes) | TCP/UDP Read(bytes) | TCP/UDP Write(bytes) | Conn. Time | Conn. Status |
|---------------------|-----------|----------------|---------------|---------------------|----------------------|---------------------|----------------------|------------|--------------|
|---------------------|-----------|----------------|---------------|---------------------|----------------------|---------------------|----------------------|------------|--------------|

| OpenVPN Client Status |               |  |
|-----------------------|---------------|--|
| Item                  | Value setting | Description  |
| OpenVPN Client Name   | N/A           | It displays the Client name you have entered for identification.   |
| Interface             | N/A           | It displays the WAN interface specified for the OpenVPN client connection.   |
| Remote IP/FQDN        | N/A           | It displays the peer OpenVPN Server's Public IP address (the WAN IP address) or FQDN.                                |
| Remote Subnet         | N/A           | It displays the Remote Subnet specified.   |
| TUN/TAP Read(bytes)   | N/A           | It displays the TUN/TAP Read Bytes of OpenVPN Client.  |
| TUN/TAP Write(bytes)  | N/A           | It displays the TUN/TAP Write Bytes of OpenVPN Client.   |
| TCP/UDP Read(bytes)   | N/A           | It displays the TCP/UDP Read Bytes of OpenVPN Client.  |
| TCP/UDP Write(bytes)  | N/A           | It displays the TCP/UDP Write Bytes of OpenVPN Client. Connection  |
| Conn. Time            | N/A           | It displays the connection time for the corresponding OpenVPN tunnel.  |
| Conn. Status          | N/A           | It displays the connection status of the corresponding OpenVPN tunnel. The status can be Connected, or Disconnected. |

## L2TP Client Status

LT2TP Client Status shows the configuration for establishing LT2TP tunnel and current connection status.

| L2TP Client Name | Interface | Virtual IP | Remote IP/FQDN | Default Gateway/Remote Subnet | Conn. Time | Status |
|------------------|-----------|------------|----------------|-------------------------------|------------|--------|
|------------------|-----------|------------|----------------|-------------------------------|------------|--------|

| L2TP Client Status            |               |   |
|-------------------------------|---------------|---|
| Item                          | Value setting | Description   |
| Client Name                   | N/A           | It displays Name for the L2TP Client specified.   |
| Interface                     | N/A           | It displays the WAN interface with which the router will use to request PPTP tunneling connection to the PPTP server.   |
| Virtual IP                    | N/A           | It displays the IP address assigned by Virtual IP server of L2TP server.  |
| Remote IP/FQDN                | N/A           | It displays the L2TP Server's Public IP address (the WAN IP address) or FQDN.   |
| Default Gateway/Remote Subnet | N/A           | It displays the specified IP address of the gateway device used to connect to the internet to connect to the L2TP server –the default gateway. Or other specified subnet if the default gateway is not used to connect to the L2TP server –the remote subnet. |
| Conn. Time                    | N/A           | It displays the connection time for the L2TP tunnel.  |
| Status                        | N/A           | It displays the Status of the VPN connection. The status displays Connected, Disconnect, and Connecting.  |
| Edit                          | N/A           | Click on <b>Edit</b> Button to change L2TP client setting, web-based utility will take you to the L2TP client page. ( <b>Security &gt; VPN &gt; L2TP</b> tab)   |

## PPTP Client Status

PPTP Client Status shows the configuration for establishing PPTP tunnel and current connection status.

|  |           |            |                |                               |            |        |
|--|-----------|------------|----------------|-------------------------------|------------|--------|
| PPTP Client Status <span style="float: right;">Edit</span> |           |            |                |                               |            |        |
| PPTP Client Name   | Interface | Virtual IP | Remote IP/FQDN | Default Gateway/Remote Subnet | Conn. Time | Status |

| PPTP Client Status              |               |   |
|---------------------------------|---------------|---|
| Item                            | Value setting | Description   |
| Client Name                     | N/A           | It displays Name for the PPTP Client specified.   |
| Interface                       | N/A           | It displays the WAN interface with which the gateway will use to request PPTP tunneling connection to the PPTP server.  |
| Virtual IP                      | N/A           | It displays the IP address assigned by Virtual IP server of PPTP server.  |
| Remote IP/FQDN                  | N/A           | It displays the PPTP Server's Public IP address (the WAN IP address) or FQDN.   |
| Default Gateway / Remote Subnet | N/A           | It displays the specified IP address of the gateway device used to connect to the internet to connect to the PPTP server –the default gateway. Or other specified subnet if the default gateway is not used to connect to the PPTP server –the remote subnet. |
| Conn. Time                      | N/A           | It displays the connection time for the PPTP tunnel.  |
| Status                          | N/A           | It displays the Status of the VPN connection. The status displays Connected, Disconnect, and Connecting.  |
| Edit Button                     | N/A           | Click on <b>Edit</b> Button to change PPTP client setting, web-based utility will take you to the PPTP server page. ( <b>Security &gt; VPN &gt; PPTP</b> tab)   |

### 7.2.2 Firewall Status

Go to **Status > Security > Firewall** Tab.

The **Firewall** provides user a quick view of the firewall status and current firewall settings. It also keeps the log history of the dropped packets by the firewall rule policies, and includes the administrator remote login settings specified in the Firewall Options.

By clicking the icon [+], the status table will be expanded to display log history. Clicking the **Edit** button the screen will be switched to the configuration page.

#### Packet Filter Status

| <input type="checkbox"/> Packet Filters <span style="float: right;">Edit</span> <span style="float: right;">[ + ]</span> |                   |    |      |
|--|-------------------|----|------|
| Activated Filter Rule  | Detected Contents | IP | Time |

| Packet Filter Status  |               |  |
|-----------------------|---------------|--|
| Item                  | Value setting | Description  |
| Activated Filter Rule | N/A           | This is the Packet Filter Rule name.   |
| Detected Contents     | N/A           | This is the logged packet information, including the source IP, destination IP, protocol, and destination port –the TCP or UDP.<br>String format:<br>Source IP to Destination IP : Destination Protocol (TCP or UDP) |
| IP                    | N/A           | The Source IP (IPv4) of the logged packet.   |
| Time                  | N/A           | The Date and Time stamp of the logged packet. Date & time format. ("Month" "Day" "Hours":"Minutes":"Seconds")  |

*Note: Ensure Packet Filter Log Alert is enabled.*

*Refer to Security > Firewall > Packet Filter tab. Check Log Alert and save the setting.*

#### URL Blocking Status

| <input type="checkbox"/> URL Blocking <span style="float: right;">Edit</span> <span style="float: right;">[ + ]</span> |             |    |      |
|--|-------------|----|------|
| Activated Blocking Rule  | Blocked URL | IP | Time |

| URL Blocking Status     |               |   |
|-------------------------|---------------|---|
| Item                    | Value setting | Description   |
| Activated Blocking Rule | N/A           | This is the URL Blocking Rule name.   |
| Blocked URL             | N/A           | This is the logged packet information.  |
| IP                      | N/A           | The Source IP (IPv4) of the logged packet.  |
| Time                    | N/A           | The Date and Time stamp of the logged packet. Date & time format. ("Month" "Day" "Hours":"Minutes":"Seconds") |

*Note: Ensure URL Blocking Log Alert is enabled.*

*Refer to Security > Firewall > URL Blocking tab. Check Log Alert and save the setting.*

### MAC Control Status

|   |                              |           |             |
|---|------------------------------|-----------|-------------|
| <input type="checkbox"/> MAC Control <span>Edit</span> <span>[ + ]</span> |                              |           |             |
| <b>Activated Control Rule</b>   | <b>Blocked MAC Addresses</b> | <b>IP</b> | <b>Time</b> |

| MAC Control Status     |               |   |
|------------------------|---------------|---|
| Item                   | Value setting | Description   |
| Activated Control Rule | N/A           | This is the MAC Control Rule name.  |
| Blocked MAC Addresses  | N/A           | This is the MAC address of the logged packet.   |
| IP                     | N/A           | The Source IP (IPv4) of the logged packet.  |
| Time                   | N/A           | The Date and Time stamp of the logged packet. Date & time format. ("Month" "Day" "Hours":"Minutes":"Seconds") |

Note: Ensure MAC Control Log Alert is enabled.  
 Refer to **Security > Firewall > MAC Control** tab. Check Log Alert and save the setting.

### IPS Status

|   |           |             |
|---|-----------|-------------|
| <input type="checkbox"/> IPS <span>Edit</span> <span>[ + ]</span> |           |             |
| <b>Detected Intrusion</b>   | <b>IP</b> | <b>Time</b> |

| IPS Firewall Status |               |   |
|---------------------|---------------|---|
| Item                | Value setting | Description   |
| Detected Intrusion  | N/A           | This is the intrusion type of the packets being blocked.  |
| IP                  | N/A           | The Source IP (IPv4) of the logged packet.  |
| Time                | N/A           | The Date and Time stamp of the logged packet. Date & time format. ("Month" "Day" "Hours":"Minutes":"Seconds") |

Note: Ensure IPS Log Alert is enabled.  
 Refer to **Security > Firewall > IPS** tab. Check Log Alert and save the setting.

**Firewall Options Status**

|  |            |                              |  |
|--|------------|------------------------------|--|
| Options <span>Edit</span> <span>[+]</span> |            |                              |  |
| <b>Stealth Mode</b>                        | <b>SPI</b> | <b>Discard Ping from WAN</b> | <b>Remote Administrator Management</b> |

| Firewall Options Status                |               |   |
|--|---------------|---|
| Item                                   | Value setting | Description   |
| <b>Stealth Mode</b>                    | N/A           | Enable or Disable setting status of Stealth Mode on Firewall Options.<br>String Format: Disable or Enable   |
| <b>SPI</b>                             | N/A           | Enable or Disable setting status of SPI on Firewall Options.<br>String Format : Disable or Enable   |
| <b>Discard Ping from WAN</b>           | N/A           | Enable or Disable setting status of Discard Ping from WAN on Firewall Options.<br>String Format: Disable or Enable  |
| <b>Remote Administrator Management</b> | N/A           | Enable or Disable setting status of Remote Administrator.<br>If Remote Administrator is enabled, it shows the currently logged in administrator's source IP address and login user name and the login time.<br>Format:<br>IP : "Source IP", User Name: "Login User Name", Time: "Date time"<br>Example:<br>IP: 192.168.127.39, User Name: admin, Time: Mar 3 01:34:13 |

*Note: Ensure Firewall Options Log Alert is enabled.*

*Refer to **Security > Firewall > Options** tab. Check Log Alert and save the setting.*

## 7.3 Administration

### 7.3.1 Configure & Manage Status

Go to **Status > Administration > Configure & Manage** tab.

The **Configure & Manage Status** window shows the status for managing remote network devices. The type of management available in your device is depended on the device model purchased. The commonly used ones are the SNMP, TR-069, and UPnP.

#### SNMP Linking Status

**SNMP Link Status** screen shows the status of current active SNMP connections.

| SNMP Linking Status |            |      |           |            |              |              |
|---------------------|------------|------|-----------|------------|--------------|--------------|
| User Name           | IP Address | Port | Community | Auth. Mode | Privacy Mode | SNMP Version |

| SNMP Link Status |               |  |
|------------------|---------------|--|
| Item             | Value setting | Description  |
| User Name        | N/A           | It displays the user name for authentication. This is only available for SNMP version 3. |
| IP Address       | N/A           | It displays the IP address of SNMP manager.  |
| Port             | N/A           | It displays the port number used to maintain connection with the SNMP manager.           |
| Community        | N/A           | It displays the community for SNMP version 1 or version 2c only.                         |
| Auth. Mode       | N/A           | It displays the authentication method for SNMP version 3 only.                           |
| Privacy Mode     | N/A           | It displays the privacy mode for version 3 only.   |
| SNMP Version     | N/A           | It displays the SNMP Version employed.   |

### SNMP Trap Information

SNMP Trap Information screen shows the status of current received SNMP traps.

|  |             |                   |
|--|-------------|-------------------|
| <input type="checkbox"/> SNMP Trap Information |             |                   |
| <b>Trap Level</b>                              | <b>Time</b> | <b>Trap Event</b> |

| SNMP Trap Information |               |   |
|-----------------------|---------------|---|
| Item                  | Value setting | Description   |
| Trap Level            | N/A           | It displays the trap level.                                   |
| Time                  | N/A           | It displays the timestamp of trap event.                      |
| Trap Event            | N/A           | It displays the IP address of the trap sender and event type. |

### TR-069 Status

TR-069 Status screen shows the current connection status with the TR-068 server.

|  |
|--|
| <input type="checkbox"/> TR-069 Status |
| <b>Link Status</b>                     |
| On                                     |

| TR-069 Status |               |  |
|---------------|---------------|--|
| Item          | Value setting | Description  |
| Link Status   | N/A           | It displays the current connection status with the TR-068 server. The connection status is either On when the device is connected with the TR-068 server or Off when disconnected. |

## 7.4 Statistics & Report

Connection Session | Login Statistics | Cellular Usage

Internet Surfing List (1 entries) Previous Next First Last Export (.xml) Export (.csv) Refresh

| User Name | Protocol | Internal IP & Port | MAC | External IP &Port | Duration Time     |
|-----------|----------|--------------------|-----|-------------------|-------------------|
|           | TCP      | 46.13.7.58:60722   |     | 89.24.3.207:443   | 2018/08/20 14:49~ |

### 7.4.1 Connection Session

Go to **Status > Statistics & Reports > Connection Session** tab.

**Internet Surfing Statistic** shows the connection tracks on this router.

Internet Surfing List (19 entries) Previous Next First Last Export (.xml)

Export (.csv) Refresh

| User Name | Protocol | Internal IP & Port | MAC | External IP &Port | Duration Time     |
|-----------|----------|--------------------|-----|-------------------|-------------------|
|           | UDP      | 10.156.42.188:3356 |     | 217.77.165.81:53  | 2018/09/05 06:31~ |
|           | UDP      | 10.156.42.188:1626 |     | 217.77.165.81:53  | 2018/09/05 06:31~ |
|           | UDP      | 10.156.42.188:3265 |     | 217.77.165.81:53  | 2018/09/05 06:31~ |
|           | UDP      | 10.156.42.188:3111 |     | 217.77.165.81:53  | 2018/09/05 06:31~ |
|           | UDP      | 10.156.42.188:4444 |     | 217.77.165.81:53  | 2018/09/05 06:31~ |

| Internet Surfing Statistic |               |   |
|----------------------------|---------------|---|
| Item                       | Value setting | Description   |
| Previous                   | N/A           | Click the <b>Previous</b> button; you will see the previous page of track list. |
| Next                       | N/A           | Click the <b>Next</b> button; you will see the next page of track list.         |
| First                      | N/A           | Click the <b>First</b> button; you will see the first page of track list.       |
| Last                       | N/A           | Click the <b>Last</b> button; you will see the last page of track list.         |
| Export (.xml)              | N/A           | Click the <b>Export (.xml)</b> button to export the list to xml file.           |
| Export (.csv)              | N/A           | Click the <b>Export (.csv)</b> button to export the list to csv file.           |
| Refresh                    | N/A           | Click the <b>Refresh</b> button to refresh the list.                            |



### 7.4.2 Device Administration

Go to **Status > Statistics & Reports > Login Statistics** tab.

**Login Statistics** shows the login information.

| <input type="checkbox"/> Device Manager Login Statistics <input type="button" value="Previous"/> <input type="button" value="Next"/> <input type="button" value="First"/> <input type="button" value="Last"/> <input type="button" value="Export (.xml)"/> <input type="button" value="Export (.csv)"/> <input type="button" value="Refresh"/> |               |            |            |                   |
|--|---------------|------------|------------|-------------------|
| User Name  | Protocol Type | IP Address | User Level | Duration Time     |
| admin  | http/https    | 10.64.0.1  | Admin      | 2018/09/04 07:54~ |

| Device Manager Login Statistic |               |   |
|--------------------------------|---------------|---|
| Item                           | Value setting | Description   |
| Previous                       | N/A           | Click the <b>Previous</b> button; you will see the previous page of login statistics. |
| Next                           | N/A           | Click the <b>Next</b> button; you will see the next page of login statistics.         |
| First                          | N/A           | Click the <b>First</b> button; you will see the first page of login statistics.       |
| Last                           | N/A           | Click the <b>Last</b> button; you will see the last page of login statistics.         |
| Export (.xml)                  | N/A           | Click the <b>Export (.xml)</b> button to export the login statistics to xml file.     |
| Export (.csv)                  | N/A           | Click the <b>Export (.csv)</b> button to export the login statistics to csv file.     |
| Refresh                        | N/A           | Click the <b>Refresh</b> button to refresh the login statistics.                      |

### 7.4.3 Cellular Usage

Go to **Status > Statistics & Reports > Cellular Usage** tab.

**Cellular Usage** screen shows data usage statistics for the selected cellular interface. The cellular data usage can be accumulated per hour or per day.

▣ Data Usage Record

3G/4G-1 ▾ SIM A ▾ Hourly ▾

## 8. GPL Written Offer

This product incorporates open source software components covered by the terms of third party copyright notices and license agreements contained below.

### **GPSBabel**

Version 1.4.4

Copyright (C) 2002-2005 Robert Lipe<robertlipe@usa.net>

GPL License: <https://www.gpsbabel.org/>

### **Curl**

Version 7.19.6

Copyright (c) 1996-2009, Daniel Stenberg, <daniel@haxx.se>.

MIT/X derivate License: <https://curl.haxx.se/>

### **OpenSSL**

Version 1.0.2c

Copyright (C) 1995-1998 Eric Young (eay@cryptsoft.com)

GPL License: <https://www.openssl.org/>

### **brctl** - ethernet bridge administration

Stephen Hemminger <shemminger@osdl.org>

Lennert Buytenhek <buytenh@gnu.org>

version 1.1

GNU GENERAL PUBLIC LICENSE Version 2, June 1991

### **tc** - show / manipulate traffic control settings

Stephen Hemminger<shemminger@osdl.org>

Alexey Kuznetsov<kuznet@ms2.inr.ac.ru>

version iproute2-ss050330

GNU GENERAL PUBLIC LICENSE Version 2, June 1991

### **dhcp-fwd** — starts the DHCP forwarding agent

Enrico Scholz <enrico.scholz@informatik.tu-chemnitz.de>

version 0.7

GNU GENERAL PUBLIC LICENSE Version 2, June 1991

### **lftp** - Sophisticated file transfer program

Alexander V. Lukyanov <lav@yars.free.net>

version:4.5.x

Copyright (c) 1996-2014 by Alexander V. Lukyanov (lav@yars.free.net)

**dnsmasq** - A lightweight DHCP and caching DNS server.

Simon Kelley <simon@thekelleys.org.uk>

version:2.72

dnsmasq is Copyright (c) 2000-2014 Simon Kelley

**socat** - Multipurpose relay

Version: 2.0.0-b8

GPLv2

<http://www.dest-unreach.org/socat/>

**LibModbus**

Version: 3.0.3

LGPL v2

<http://libmodbus.org/news/>

**LibIEC60870**

GPLv2

Copyright (C) 1989, 1991 Free Software Foundation, Inc. 59 Temple Place, Suite 330, Boston, MA 02111-1307 USA

<https://sourceforge.net/projects/mrts/>

**Openswan**

Version: v2.6.38 GNU GENERAL PUBLIC LICENSE Version 2, June 1991

Copyright (C) 1989, 1991 Free Software Foundation, Inc. 59 Temple Place, Suite 330, Boston, MA 02111-1307 USA

Everyone is permitted to copy and distribute verbatim copies of this license document, but changing it is not allowed.

<https://www.openswan.org/>

**Opennhrp**

Version: v0.14.1

OpenNHRP is an NHRP implementation for Linux. It has most of the RFC2332 and Cisco IOS extensions.

Project homepage: <http://sourceforge.net/projects/opennhrp>

Git repository: <git://opennhrp.git.sourceforge.net/gitroot/opennhrp>

LICENSE

OpenNHRP is licensed under the MIT License. See MIT-LICENSE.txt for additional details.

OpenNHRP embeds libev. libev is dual licensed with 2-clause BSD and GPLv2+ licenses. See libev/LICENSE for additional details.

OpenNHRP links to c-ares. c-ares is licensed under the MIT License.

<https://sourceforge.net/projects/opennhrp/>

**IPSec-tools**

Version: v0.8

No GPL be written

<http://ipsec-tools.sourceforge.net/>

**PPTP**

Version: pptp-1.7.1

GNU GENERAL PUBLIC LICENSE Version 2, June 1991

Copyright (C) 1989, 1991 Free Software Foundation, Inc. 675 Mass Ave, Cambridge, MA 02139, USA

Everyone is permitted to copy and distribute verbatim copies of this license document, but changing it is not allowed.

<http://pptpclient.sourceforge.net/>

**PPTPServ**

Version: 1.3.4

GNU GENERAL PUBLIC LICENSE Version 2, June 1991

Copyright (C) 1989, 1991 Free Software Foundation, Inc. 675 Mass Ave, Cambridge, MA 02139, USA

Everyone is permitted to copy and distribute verbatim copies of this license document, but changing it is not allowed. <http://poptop.sourceforge.net/>

**L2TP**

Version: 0.4

Copying All software included in this package is Copyright 2002 Roaring

Penguin Software Inc. You may distribute it under the terms of the GNU General Public License (the "GPL"), Version 2, or (at your option) any later version.

<http://www.roaringpenguin.com/>

**L2TPServ**

Version: v 1.3.1 GNU GENERAL PUBLIC LICENSE Version 2, June 1991

Copyright (C) 1989, 1991 Free Software Foundation, Inc. 59 Temple Place, Suite 330, Boston, MA 02111-1307 USA

Everyone is permitted to copy and distribute verbatim copies of this license document, but changing it is not allowed.

<http://www.xelerance.com/software/xl2tpd/>

**Mpstat:** from sysstat, system performance tools for Linux

Version: 10.1.6

Copyright: (C) 1999-2013 by Sebastien Godard (sysstat <at> orange.fr)

**SSHD:** dropbear, a SSH2 server

Version: 0.53.1

Copyright: (c) 2002-2008 Matt Johnston

**Libncurses:** The ncurses (new curses) library is a free software emulation of curses in System V Release 4.0 (SVr4), and more.

Version: 5.9

Copyright: (c) 1998, 2000, 2004, 2005, 2006, 2008, 2011, 2015 Free Software Foundation, Inc., 51 Franklin Street, Boston, MA 02110-1301, USA

**MiniUPnP:** The miniUPnP daemon is an UPnP IGD (internet gateway device) which provide NAT traversal services to any UPnP enabled client on the network.

Version: 1.7

Copyright: (c) 2006-2011, Thomas BERNARD

**CoovaChilli** is an open-source software access controller for captive portal (UAM) and 802.1X access provisioning.

Version: 1.3.0

Copyright: (C) 2007-2012 David Bird (Coova Technologies) <support@coova.com>

**Krb5:** Kerberos is a network authentication protocol. It is designed to provide strong authentication for client/server applications by using secret-key cryptography.

Version: 1.11.3

Copyright: (C) 1985-2013 by the Massachusetts Institute of Technology and its contributors

**OpenLDAP:** a suite of the Lightweight Directory Access Protocol (v3) servers, clients, utilities, and development tools.

Version: 2.4

Copyright: 1998-2014 The OpenLDAP Foundation

**Samba3311:** the free SMB and CIFS client and server for UNIX and other operating systems

Version: 3.3.11

Copyright: (C) 2007 Free Software Foundation, Inc. <<http://fsf.org/>>

**NTPClient:** an NTP (RFC-1305, RFC-4330) client for unix-alike computers

Version: 2007\_365

Copyright: 1997, 1999, 2000, 2003, 2006, 2007 Larry Doolittle

**exFAT:** FUSE-based exFAT implementation

Version: 0.9.8

Copyright: (C) 2010-2012 Andrew Nayenko

**NTFS\_3G:** The NTFS-3G driver is an open source, freely available read/write NTFS driver for Linux, FreeBSD, Mac OS X, NetBSD, Solaris and Haiku.

Version: 2009.4.4

Copyright: (C) 1989, 1991 Free Software Foundation, Inc., 51 Franklin Street, Fifth Floor, Boston, MA 02110-1301 USA

**mysql-5\_1\_72:** a release of MySQL, a dual-license SQL database server

Version: 5.1.72

Copyright: (c) 2000, 2013, Oracle and/or its affiliates

FreeRadius: a high performance and highly configurable RADIUS server

Version: 2.1.12

Copyright: (C) 1999-2011 The FreeRADIUS server project and contributors

Linux IPv6 Router Advertisement Daemon – **radvd**

Version: V 1.15

Copyright (c) 1996,1997 by Lars Fenneberg<lf@elemental.net>

BSD License: <http://www.litech.org/radvd/>

**WIDE-DHCPv6**

Dynamic Host Configuration Protocol for IPv6 (DHCPv6) clients, servers, and relay agents.

Version: 20080615

Copyright (C) 1998-2004 WIDE Project.

BSD License: <https://sourceforge.net/projects/wide-dhcpv6/>

## 9. Recommended literature

- [1] Advantech B+B SmartWorx: **Start Guide for ICR-1601**,
- [2] Advantech B+B SmartWorx: **ICR-1601 User Manual**.



Product related documents and applications can be obtained on Engineering Portal at <https://ep.advantech-bb.cz/> address.



## 10. Customers Support

### 10.1 Customer Support for NAM

E-mail: [support@advantech-bb.com](mailto:support@advantech-bb.com)

Web: [www.advantech-bb.com](http://www.advantech-bb.com)

### 10.2 Customer Support for Europe

E-mail: [iotcustomerservice@advantech.eu](mailto:iotcustomerservice@advantech.eu)

Web: [www.advantech-bb.com](http://www.advantech-bb.com)

### 10.3 Customer Support for Asia

E-mail: [icg.support@advantech.com.tw](mailto:icg.support@advantech.com.tw)

Web: [www.advantech.com](http://www.advantech.com)



#### Upkeep – Advices:

- The SIM-card must be handled carefully as with a credit card. Don't bend, don't scratch on this and do not expose to static electricity.
- During cleaning of the router do not use aggressive chemicals, solvents and abrasive cleaners!



Hereby, Advantech Co., Ltd. company declares that the radio equipment type ICR-1601 is in compliance with EU Directive **2014/53/EU**.

The full text of the EU Declaration of Conformity is available at the following internet address:  
[www.advantech-bb.cz/eudoc](http://www.advantech-bb.cz/eudoc).