

Industrial Cellular Router

ICR-2000, ICR-2400, ICR-2500, ICR-2600

CONFIGURATION MANUAL

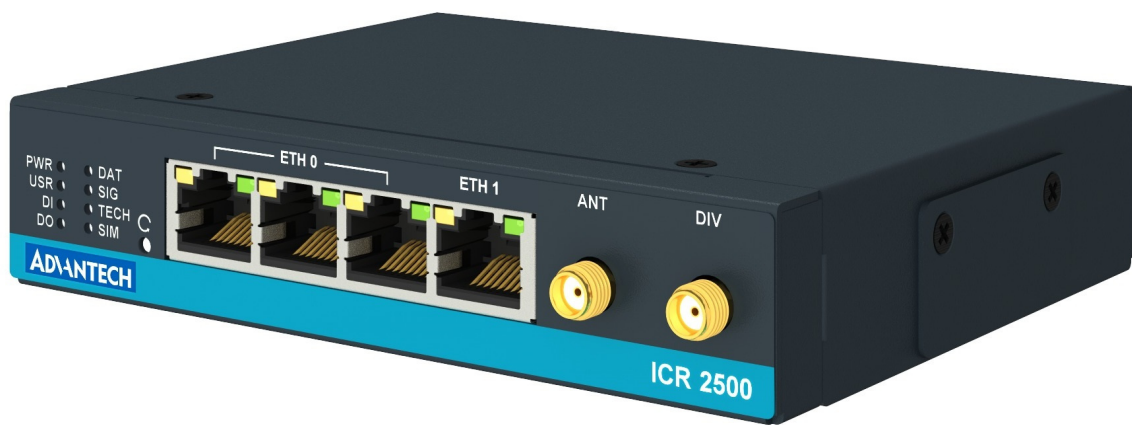

ADVANTECH

Used Symbols



Danger – Information regarding user safety or potential damage to the router.



Attention – Problems that can arise in specific situations.



Information, notice – Useful tips or information of special interest.



Example – Example of function, command or script.

Firmware Version

Current version of firmware is 6.3.3 (December 13, 2021).

Open Source Software License

The software in this device uses various pieces of open source software governed by following licenses: GPL versions 2 and 3, LGPL version 2, BSD-style licenses, MIT-style licenses. The list of components together with complete license texts can be found on the device itself: See the *Licenses* link at the bottom of the router's main Web page (*General Status*) or point your browser to address `DEVICE_IP/licenses.cgi`. If you are interested in obtaining the source, please get in touch with us at:

techSupport@advantech-bb.com

Modifications and debugging of LGPL-linked executables:

The device manufacturer hereby grants the right to use debugging techniques (e.g., de-compilation) and making customer modifications of any executable linked with a LGPL library for own purposes. Note these rights are limited to the customer's usage. No further distribution of such modified executables and no transmission of the information obtained during these actions may be done.



Advantech Czech s.r.o., Sokolska 71, 562 04 Usti nad Orlici, Czech Republic

Document No. MAN-0059-EN, revision from December 15, 2021. Released in the Czech Republic.

Contents

| | | |
|----------|--|-----------|
| 1 | Basic Information | 1 |
| 1.1 | Document Content | 1 |
| 1.2 | Product Introduction | 1 |
| 1.3 | Standard Equipment | 1 |
| 1.4 | Web Configuration GUI | 2 |
| 1.5 | WebAccess/DMP Configuration | 3 |
| 1.6 | Router Configuration Options | 3 |
| 1.7 | IPv6 Support | 3 |
| 1.8 | Supported Certificate File Types | 4 |
| 1.9 | IEEE 802.1X (RADIUS) Support | 5 |
| 2 | Web Configuration GUI | 7 |
| 2.1 | Factory Reset | 8 |
| 2.2 | HTTPS Certificate for the GUI | 8 |
| 2.3 | Valid Characters | 9 |
| 3 | Status | 10 |
| 3.1 | General Status | 10 |
| 3.1.1 | Mobile Connection | 10 |
| 3.1.2 | Ethernet Status | 11 |
| 3.1.3 | Peripheral Ports | 11 |
| 3.1.4 | System Information | 11 |
| 3.2 | Mobile WAN Status | 12 |
| 3.3 | Network Status | 16 |
| 3.4 | DHCP Status | 19 |
| 3.5 | IPsec Status | 21 |
| 3.6 | WireGuard Status | 22 |
| 3.7 | DynDNS Status | 23 |
| 3.8 | System Log | 24 |
| 4 | Configuration | 26 |
| 4.1 | Ethernet Configuration | 26 |
| 4.1.1 | DHCP Server | 28 |
| 4.1.2 | IPv6 Prefix Delegation | 29 |
| 4.1.3 | 802.1X Authentication to RADIUS Server | 30 |
| 4.1.4 | LAN Configuration Examples | 31 |
| 4.2 | VRRP Configuration | 37 |
| 4.3 | Mobile WAN Configuration | 40 |
| 4.3.1 | Connection to Mobile Network | 40 |

| | | |
|---------|---|-----|
| 4.3.2 | DNS Address Configuration | 44 |
| 4.3.3 | Check Connection to Mobile Network | 44 |
| 4.3.4 | Check Connection Example | 45 |
| 4.3.5 | Data Limit Configuration | 45 |
| 4.3.6 | Switch between SIM Cards Configuration | 45 |
| 4.3.7 | Examples of SIM Card Switching Configuration | 48 |
| 4.3.8 | PPPoE Bridge Mode Configuration | 49 |
| 4.4 | PPPoE Configuration | 50 |
| 4.5 | Backup Routes | 52 |
| 4.5.1 | Default Priorities for Backup Routes | 53 |
| 4.6 | Static Routes | 56 |
| 4.7 | Firewall Configuration | 57 |
| 4.7.1 | Example of the IPv4 Firewall Configuration | 60 |
| 4.8 | NAT Configuration | 62 |
| 4.8.1 | Examples of NAT Configuration | 65 |
| 4.9 | OpenVPN Tunnel Configuration | 69 |
| 4.9.1 | Example of the OpenVPN Tunnel Configuration in IPv4 Network | 74 |
| 4.10 | IPsec Tunnel Configuration | 75 |
| 4.10.1 | Route-based Configuration Scenarios | 75 |
| 4.10.2 | IPsec Authentication Scenarios | 76 |
| 4.10.3 | Configuration Items Description | 77 |
| 4.10.4 | Basic IPv4 IPsec Tunnel Configuration | 83 |
| 4.11 | WireGuard Tunnel Configuration | 84 |
| 4.11.1 | WireGuard IPv4 Tunnel Configuration Example | 87 |
| 4.12 | GRE Tunnels Configuration | 89 |
| 4.12.1 | Example of the GRE Tunnel Configuration | 90 |
| 4.13 | L2TP Tunnel Configuration | 92 |
| 4.13.1 | Example of the L2TP Tunnel Configuration | 94 |
| 4.14 | PPTP Tunnel Configuration | 95 |
| 4.14.1 | Example of the PPTP Tunnel Configuration | 97 |
| 4.15 | Services | 98 |
| 4.15.1 | DynDNS | 98 |
| 4.15.2 | FTP | 99 |
| 4.15.3 | HTTP | 100 |
| 4.15.4 | NTP | 101 |
| 4.15.5 | PAM | 102 |
| 4.15.6 | SNMP | 105 |
| 4.15.7 | SMTP | 109 |
| 4.15.8 | SMS | 111 |
| 4.15.9 | SSH | 120 |
| 4.15.10 | Syslog | 121 |
| 4.15.11 | Telnet | 122 |
| 4.16 | Expansion Ports – RS232, RS485 | 123 |
| 4.16.1 | Examples of the Expansion Port Configuration | 126 |

| | | |
|-----------|--|------------|
| 4.17 | Scripts | 127 |
| 4.17.1 | Startup Script | 127 |
| 4.17.2 | Example of Startup Script | 127 |
| 4.17.3 | Up/Down Scripts | 128 |
| 4.17.4 | Example of IPv6 Up/Down Script | 128 |
| 4.18 | Automatic Update Configuration | 129 |
| 4.18.1 | Example of Automatic Update | 131 |
| 4.18.2 | Example of Automatic Update Based on MAC | 132 |
| 5 | Customization | 133 |
| 5.1 | User Modules | 133 |
| 5.1.1 | Examples of Available User Modules | 134 |
| 6 | Administration | 140 |
| 6.1 | Users | 140 |
| 6.2 | Change Profile | 141 |
| 6.3 | Change Password | 142 |
| 6.4 | Set Real Time Clock | 142 |
| 6.5 | Set SMS Service Center | 143 |
| 6.6 | Unlock SIM Card | 143 |
| 6.7 | Unblock SIM Card | 144 |
| 6.8 | Send SMS | 144 |
| 6.9 | Backup Configuration | 145 |
| 6.10 | Restore Configuration | 146 |
| 6.11 | Update Firmware | 147 |
| 6.12 | Reboot | 149 |
| 6.13 | Logout | 149 |
| 7 | Typical Situations | 150 |
| 7.1 | Access to the Internet from LAN | 150 |
| 7.2 | Backup Access to the Internet from LAN | 152 |
| 7.3 | Secure Networks Interconnection or Using VPN | 155 |
| 7.4 | Serial Gateway | 157 |
| 8 | Glossary and Acronyms | 159 |
| 9 | Index | 164 |
| 10 | Related Documents | 167 |

List of Figures

| | | |
|----|--|----|
| 1 | IEEE 802.1X Functional Diagram | 5 |
| 1 | Web Configuration GUI | 7 |
| 2 | Mobile WAN status | 15 |
| 3 | Network Status | 18 |
| 4 | DHCP Status | 19 |
| 5 | IPsec Status | 21 |
| 6 | WireGuard Status Page | 22 |
| 7 | DynDNS Status | 23 |
| 8 | System Log | 24 |
| 9 | Example program syslogd start with the parameter -R | 25 |
| 10 | LAN Configuration page | 26 |
| 11 | IPv6 Address with Prefix Example | 29 |
| 12 | Network Topology for Example 1 | 31 |
| 13 | LAN Configuration for Example 1 | 32 |
| 14 | Network Topology for Example 2 | 33 |
| 15 | LAN Configuration for Example 2 | 34 |
| 16 | Network Topology for Example 3 | 35 |
| 17 | LAN Configuration for Example 3 | 36 |
| 18 | Topology of VRRP configuration example | 38 |
| 19 | Example of VRRP configuration – main router | 38 |
| 20 | Example of VRRP configuration – backup router | 39 |
| 21 | Mobile WAN Configuration | 43 |
| 22 | Check Connection Example | 45 |
| 23 | Configuration for SIM card switching Example 1 | 48 |
| 24 | Configuration for SIM card switching Example 2 | 49 |
| 25 | PPPoE Configuration | 50 |
| 26 | Backup Routes Configuration | 55 |
| 27 | Static Routes Configuration | 56 |
| 28 | Firewall Configuration – IPv6 Firewall | 57 |
| 29 | Topology for the IPv4 Firewall Configuration Example | 60 |
| 30 | IPv4 Firewall Configuration Example | 61 |
| 31 | NAT – IPv6 NAT Configuration | 63 |
| 32 | Topology for NAT Configuration Example 1 | 65 |
| 33 | NAT Configuration for Example 1 | 66 |
| 34 | Topology for NAT Configuration Example 2 | 67 |
| 35 | NAT Configuration for Example 2 | 68 |
| 36 | OpenVPN tunnel configuration | 73 |
| 37 | Topology of OpenVPN Configuration Example | 74 |
| 38 | IPsec Tunnels Configuration | 77 |
| 39 | Topology of IPsec Configuration Example | 83 |

| | | |
|----|---|-----|
| 40 | WireGuard Tunnels Configuration | 85 |
| 41 | Topology of WireGuard Configuration Example | 87 |
| 42 | Router A – WireGuard Status Page and Route Table | 88 |
| 43 | Router B – WireGuard Status Page and Route Table | 88 |
| 44 | GRE Tunnel Configuration | 90 |
| 45 | Topology of GRE Tunnel Configuration Example | 90 |
| 46 | L2TP Tunnel Configuration | 92 |
| 47 | Topology of L2TP Tunnel Configuration Example | 94 |
| 48 | PPTP Tunnel Configuration | 95 |
| 49 | Topology of PPTP Tunnel Configuration Example | 97 |
| 50 | DynDNS Configuration Example | 98 |
| 51 | Configuration of FTP server | 99 |
| 52 | Configuration of HTTP and HTTPS services | 100 |
| 53 | Example of NTP Configuration | 101 |
| 54 | Configuration of Local User Database | 102 |
| 55 | Configuration of RADIUS | 103 |
| 56 | Configuration of TACACS+ | 104 |
| 57 | OID Basic Structure | 106 |
| 58 | SNMP Configuration Example | 107 |
| 59 | MIB Browser Example | 108 |
| 60 | SMTP Client Configuration Example | 109 |
| 61 | SMS Configuration for Example 1 | 116 |
| 62 | SMS Configuration for Example 2 | 117 |
| 63 | SMS Configuration for Example 3 | 118 |
| 64 | SMS Configuration for Example 4 | 119 |
| 65 | Configuration of HTTP service | 120 |
| 66 | Syslog configuration | 121 |
| 67 | Configuration of Telnet service | 122 |
| 68 | Expansion Port Configuration | 123 |
| 69 | Example of Ethernet to serial communication configuration | 126 |
| 70 | Example of serial interface configuration | 126 |
| 71 | Example of a Startup Script | 127 |
| 72 | Example of IPv6 Up/Down Script | 128 |
| 73 | Example of Automatic Update 1 | 131 |
| 74 | Example of Automatic Update 2 | 132 |
| 75 | User modules | 133 |
| 76 | Added user module | 133 |
| 77 | Users | 141 |
| 78 | Change Profile | 141 |
| 79 | Change Password | 142 |
| 80 | Set Real Time Clock | 142 |
| 81 | Set SMS Service Center Address | 143 |
| 82 | Unlock SIM Card | 143 |
| 83 | Unblock SIM Card | 144 |

| | | |
|-----|---|-----|
| 84 | Send SMS | 144 |
| 85 | Backup Configuration | 145 |
| 86 | Restore Configuration | 146 |
| 87 | Update Firmware Administration Page | 147 |
| 88 | Process of Firmware Update | 148 |
| 89 | Reboot | 149 |
| 90 | Access to the Internet from LAN – sample topology | 150 |
| 91 | Access to the Internet from LAN – <i>Ethernet</i> configuration | 151 |
| 92 | Access to the Internet from LAN – <i>Mobile WAN</i> configuration | 151 |
| 93 | Backup access to the Internet – sample topology | 152 |
| 94 | Backup access to the Internet – Ethernet configuration | 152 |
| 95 | Backup access to the Internet – Mobile WAN configuration | 153 |
| 96 | Backup access to the Internet – Backup Routes configuration | 154 |
| 97 | Secure networks interconnection – sample topology | 155 |
| 98 | Secure networks interconnection – OpenVPN configuration | 156 |
| 99 | Serial Gateway – sample topology | 157 |
| 100 | Serial Gateway – konfigurace <i>Expansion Port 1</i> | 158 |

List of Tables

| | | |
|----|---|----|
| 1 | Supported Roles of the IEEE 802.1X Authentication | 6 |
| 1 | Mobile Connection | 11 |
| 2 | Peripheral Ports | 11 |
| 3 | System Information | 12 |
| 4 | Mobile Network Information | 13 |
| 5 | Value ranges of signal strength for different technologies. | 13 |
| 6 | Description of Periods | 14 |
| 7 | Mobile Network Statistics | 15 |
| 8 | Description of Interfaces in Network Status | 16 |
| 9 | Description of Information in Network Status | 17 |
| 10 | DHCP Status Description for IPv4 and IPv6 leases | 20 |
| 11 | Configuration of the Network Interface – IPv4 and IPv6 | 27 |
| 12 | Configuration of the Network Interface – global items | 28 |
| 13 | Configuration of Dynamic DHCP Server | 29 |
| 14 | Configuration of Static DHCP Server | 29 |
| 15 | IPv6 prefix delegation configuration | 30 |
| 16 | Configuration of 802.1X Authentication | 30 |
| 17 | VRRP configuration | 37 |
| 18 | Check connection | 38 |
| 19 | Mobile WAN Connection Configuration | 41 |
| 20 | Check Connection to Mobile Network Configuration | 45 |
| 21 | Data Limit Configuration | 46 |
| 22 | Switch between SIM cards configuration | 47 |
| 23 | Parameters for SIM card switching | 48 |
| 24 | PPPoE configuration | 51 |
| 25 | Backup Route Modes | 52 |
| 26 | Backup Routes | 53 |
| 27 | Static Routes Configuration for IPv4 | 56 |
| 28 | Filtering of Incoming Packets | 58 |
| 29 | Forwarding filtering | 59 |
| 30 | NAT Configuration | 62 |
| 31 | Remote Access Configuration | 64 |
| 32 | Configuration of Send all incoming packets to server | 64 |
| 33 | OpenVPN Configuration | 72 |
| 34 | OpenVPN Configuration Example | 74 |
| 35 | IPsec Tunnel Configuration | 81 |
| 36 | Simple IPv4 IPSec Tunnel Configuration | 83 |
| 37 | WireGuard Tunnel Configuration | 86 |
| 38 | WireGuard IPv4 Tunnel Configuration Example | 87 |
| 39 | GRE Tunnel Configuration | 89 |

| | | |
|----|--|-----|
| 40 | GRE Tunnel Configuration Example | 91 |
| 41 | L2TP Tunnel Configuration | 93 |
| 42 | L2TP Tunnel Configuration Example | 94 |
| 43 | PPTP Tunnel Configuration | 96 |
| 44 | PPTP Tunnel Configuration Example | 97 |
| 45 | DynDNS Configuration | 98 |
| 46 | Parameters for FTP service configuration | 99 |
| 47 | Parameters for HTTP and HTTPS services configuration | 100 |
| 48 | NTP Configuration | 101 |
| 49 | Available Modes of PAM | 102 |
| 50 | Configuration of RADIUS | 103 |
| 51 | Configuration of TACACS+ | 104 |
| 52 | SNMP Agent Configuration | 105 |
| 53 | SNMPv3 Configuration | 105 |
| 54 | SNMP Configuration (R-SeeNet) | 106 |
| 55 | Object identifier for binary inputs and output | 107 |
| 56 | SMTP client configuration | 109 |
| 57 | SMS Configuration | 111 |
| 58 | Control via SMS | 112 |
| 59 | Control SMS | 113 |
| 60 | Send SMS on the serial Port 1 | 113 |
| 61 | Send SMS on the serial Port 2 | 113 |
| 62 | Sending/receiving of SMS on TCP port specified | 114 |
| 63 | List of AT Commands | 115 |
| 64 | Parameters for SSH service configuration | 120 |
| 65 | Syslog configuration | 121 |
| 66 | Parameters for Telnet service configuration | 122 |
| 67 | Expansion Port Configuration – serial interface | 124 |
| 68 | Expansion Port Configuration – <i>Check TCP connection</i> | 124 |
| 69 | CD Signal Description | 125 |
| 70 | DTR Signal Description | 125 |
| 71 | Automatic Update Configuration | 129 |
| 72 | Connectivity User Modules | 134 |
| 73 | Routing User Modules | 135 |
| 74 | Services User Modules | 136 |
| 75 | Administration User Modules | 137 |
| 76 | Protocol Conversion User Modules | 138 |
| 77 | Node-RED User Modules | 138 |
| 78 | Integration User Modules | 139 |
| 79 | Development User Modules | 139 |
| 80 | Users Overview | 140 |
| 81 | Add User | 140 |

1. Basic Information

1.1 Document Content

This configuration manual describes the configuration of Advantech ICR v2i family routers. The manual contains especially the following information:

- Basic information about the product, notes to the HW and SW – Chapter 1.
- Notes to the web configuration GUI – Chapter 2.
- Router configuration item by item according to the web interface – Chapters 3 to 6.
- Configuration in typical situations examples – Chapter 7:
 - Access to the Internet from LAN (Local Area Network) via mobile network.
 - Backed up access to the Internet (from LAN).
 - Secure networks interconnection or using VPN (Virtual Private Network).
 - Serial Gateway (connection of serial devices to the Internet).

1.2 Product Introduction

Industrial cellular routers, described in this manual, are designed for wireless communication in the mobile networks that make use of traditional cellular technologies.

The primary purpose of these routers is the usage in services on the cellular **LTE network**. These routers are capable of achieving typical speeds in 4G coverage areas where the network is enabled with 20 MHz of contiguous spectrum.

The peak **downlink** data rate is approximately **150 Mbps**. Also in the **uplink**, LTE Category 4 provides a peak data rate of **50 Mbps**.

The router is an ideal solution for industrial wireless connection of traffic and security camera systems, individual computers, LANs, automatic teller machines (ATM), other self-service terminals, and many other devices.

1.3 Standard Equipment

Standard features include the LTE cellular module (with two antenna connectors – for main and diversity antenna), one or two independently configurable **Ethernet interfaces**, one **digital input** together with one **digital output**, and one or two SIM card readers. Some models are equipped with **RS232** and **RS485** serial ports. The router is supplied in a metal casing.

1.4 Web Configuration GUI

Configuring routers is made easy by name and password-protected web interface. The interface provides detailed statistics about router activities, signal strength, system logs and more. The router supports both IPv4 and IPv6 protocols, the creation of secure VPN tunnels using technologies IPsec, OpenVPN and L2TP. The router also supports DHCP, NAT, NAT-T, DynDNS client, NTP, VRRP, control by SMS, backup of the primary connection, multiple WANs, RADIUS authentication on Ethernet, and many other functions.

Additional diagnostic features designed to ensure continuous communication include automatic inspection of Mobile WAN connections, an automatic restart feature in case a connection is lost, and a hardware watchdog that monitors the status of the router. Using a startup script window, users can insert Linux scripts for various actions. Users may insert multiple scripts, and the router can switch between configurations as needed. Examples would include using SMS or checking the status of the binary input. The routers can automatically update their configurations and firmware from a central server, allowing for mass reconfiguration of multiple routers simultaneously.

1.5 WebAccess/DMP Configuration

WebAccess/DMP is an advanced enterprise-grade platform solution for provisioning, monitoring, managing, and configuring Advantech's routers and IoT gateways. See the application note [2] for more information or visit the [WebAccess/DMP webpage](#).

New routers have been pre-installed with the *WebAccess/DMP* client. For its activation, enable it in the router's web interface (*Customization -> User Modules -> WebAccess/DMP Client*).



The activated client periodically uploads router identifiers, its configuration, and cellular network statistics to the *WebAccess/DMP* server.

With the *WebAccess/DMP* client activated, you may configure the router from *WebAccess/DMP* portal. Navigate your browser to <https://www.wadmp.com>.

If this is your first time, please self-sign-up with the site. If not, please log in with your username and password. Once logged in, further assistance can be found at <https://docs.wadmp.com>.

1.6 Router Configuration Options

Routers can be configured via a web browser or Secure Shell (SSH). Configuration via Web Browser is described in this Configuration Manual. Commands and scripts applicable in the configuration using SSH are described in *Commands and Scripts for v2 and v3 Routers – Application Note* [1]. Technical parameters and a full description of the router can be found in the User Manual of your router. You can also use additional software – [WebAccess/VPN](#) [2] and software for router monitoring R-SeeNet [3].

1.7 IPv6 Support

There is an independent IPv4 and IPv6 dual-stack configuration implemented in the router's firmware. This means that you can configure traffic through both IP protocols independently and both are supported. Additional EUI-64 IPv6 addresses of network interfaces are generated automatically by standard methods. In addition, there is a NAT64 internal gateway network interface for automatic translation between IPv6 and IPv4 (see Chapter 3.3 for more information). This gateway works together with DNS64 seamlessly (for domain names translation).

For cellular IPv6 connection, see *Mobile WAN Configuration* in Chapter 4.3.1. For IPv6 LAN configuration, see *LAN Configuration* in Chapter 4.1. DHCPv6 server/client is also supported. IPv4 is the default, but IPv6 can be enabled or used with all features and protocols in the router, except for non-secured tunnels GRE, L2TP and PPTP, and VRRP. Using the secured tunnels OpenVPN and IPsec, it is possible to run IPv6 traffic through an IPv4 tunnel and vice versa. The configuration forms for *NAT*, *Firewall* and *Up/Down Scripts* are completely separate for the IPv4 and IPv6 stacks. ICMPv6 protocol is also supported. IPv6 configuration is covered in each following Chapter when possible.

1.8 Supported Certificate File Types

All the GUI forms supporting the uploading of a certificate file support these file types:

- CA, Local/Remote Certificate: **.pem; *.crt; *.p12*
- Private Key: **.pem; *.key; *.p12*

1.9 IEEE 802.1X (RADIUS) Support

IEEE 802.1X is an **IEEE Standard** for **port-based Network Access Control (PNAC)**. It is part of the IEEE 802.1 group of networking protocols. It provides an **authentication mechanism** to devices wishing to attach to a LAN or WLAN. IEEE 802.1X defines the encapsulation of the **Extensible Authentication Protocol (EAP)** over IEEE 802, which is known as "EAP over LAN" or **EAPoL**.

802.1X authentication involves three parties: **a supplicant, an authenticator, and an authentication server** (see Figure 1).

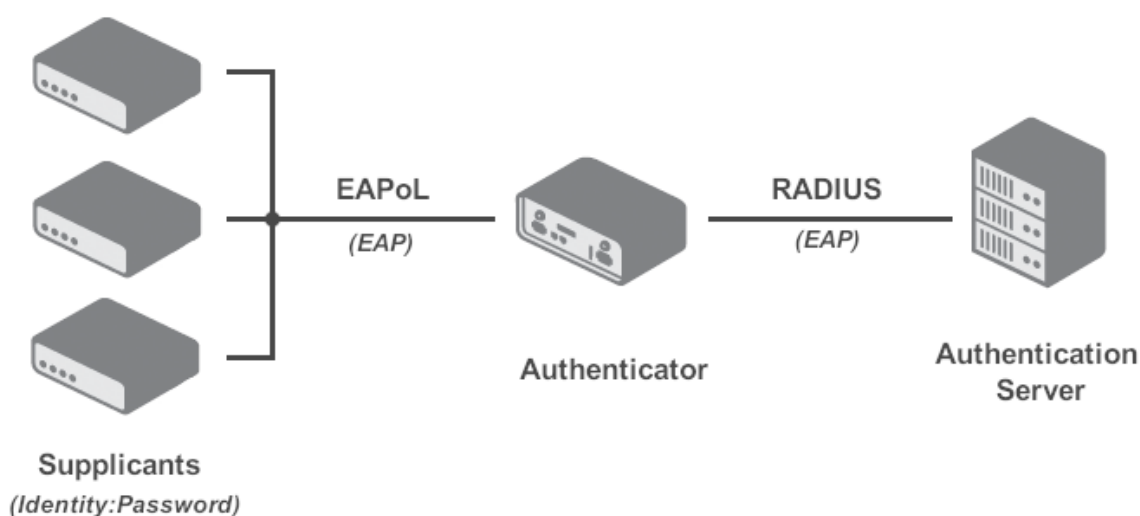

Figure 1: IEEE 802.1X Functional Diagram

- The **supplicant** is a client device (such as a laptop) that wishes to attach to the LAN/WLAN. The term 'supplicant' is also used interchangeably to refer to the software running on the client that provides credentials to the authenticator.
- The **authenticator** is a network device which provides a data link between the client (supplicant) and the network (LAN/WAN) and can allow or block network traffic between the two, such as an Ethernet switch or wireless access point. The authenticator communicates with the authentication server to determine if the network access for a supplicant will be granted or not.
- The **authentication server** is typically a trusted server that can receive and respond to requests for network access, and can tell the authenticator if the connection is to be allowed, and various settings that should apply to that client's connection or setting. Authentication servers typically run software supporting the **RADIUS** and **EAP protocols**.

Table 1 summarizes all the supported cases and roles when the IEEE 802.1X authentication can be used on Advantech routers.



Please note that the role of the authentication server is not supported by Advantech routers.

| Interface | Supplicant Role | Authenticator Role |
|-----------|---|---|
| LAN | Built-in feature, just configure the LAN with 802.1X authentication, see Chapter 4.1.3. | Not built-in feature, but can be implemented by the UM <i>802.1X Authenticator</i> . For more information about this module see [UM]. |

Table 1: Supported Roles of the IEEE 802.1X Authentication

2. Web Configuration GUI

| | |
|---|---|
| Status | General Status |
| <ul style="list-style-type: none"> General Mobile WAN Network DHCP IPsec DynDNS System Log | <div style="background-color: #e6f2ff; padding: 2px;">Mobile Connection</div> <p> SIM Card : 1st IP Address : 10.80.0.86 IPv6 Address : Unassigned Rx Data : 580 B Tx Data : 1.6 KB Uptime : 0 days, 1 hour, 37 minutes » More Information « </p> <div style="background-color: #e6f2ff; padding: 2px;">ETH0</div> <p> IP Address : 10.64.0.101 / 255.255.252.0 IPv6 Address : fd00:a40::101 / 56 MAC Address : 02:AD:FF:00:01:01 Rx Data : 9.7 KB Tx Data : 16.6 KB » More Information « </p> <div style="background-color: #e6f2ff; padding: 2px;">Peripheral Ports</div> <p> Binary Input : Off Binary Output : Off </p> <div style="background-color: #e6f2ff; padding: 2px;">System Information</div> <p> Firmware Version : x.x.x (yyyy-mm-dd) Serial Number : ACZ1199000001015 Hardware UUID : N/A Profile : Standard Time : 2021-01-28 07:37:31 Uptime : 0 days, 1 hour, 37 minutes » Licenses « </p> |
| Configuration | |
| <ul style="list-style-type: none"> Ethernet VRRP Mobile WAN PPPoE Backup Routes Static Routes Firewall NAT OpenVPN IPsec GRE L2TP PPTP Services Scripts Automatic Update | |
| Customization | |
| User Modules | |
| Administration | |
| <ul style="list-style-type: none"> Users Change Profile Change Password Set Real Time Clock Set SMS Service Center Unlock SIM Card Unblock SIM Card Send SMS Backup Configuration Restore Configuration Update Firmware Reboot Logout | |

Figure 1: Web Configuration GUI



The cellular router will not operate unless the cellular carrier has been correctly configured and the account activated and provisioned for data communications. For UMTS and LTE carriers, a SIM card must be inserted into the router. Do not insert the SIM card when the router is powered up.

You may use the web interface to monitor, configure and manage the router. To access the router over the web interface enter the router's IP address in your browser. The default address is **192.168.1.1**. Only access via secured **HTTPS** protocol is permitted. So the syntax for the IP address must be *https://192.168.1.1*. When accessing the router for the first time you will need to install a security certificate if you don't want the browser to show you a domain disagreement message. To avoid receiving domain disagreement messages, follow the procedure described in the following subchapter.

The default username is **root**. The default password is printed on the router's label. Change the default password as soon as possible!



For increased security of the network connected to the router, change the default router password. When the default password of the router is still active, the **Change password** title is highlighted in red.



After three unsuccessful login attempts, any HTTP(S) access from an IP address is blocked for one minute.

When you successfully enter login information on the login page, the web interface will be displayed, see Figure 1. The left side of the web interface contains a menu tree with sections for *Status* monitoring, *Configuration*, *Customization*, and *Administration* of the router.



The *Name* and *Location* fields, identifying the router, can be displayed in the right upper corner of the web interface. It can be configured in the SNMP configuration (see 4.15.6).

2.1 Factory Reset

After the *PWR* LED starts to blink you may restore the initial router settings by pressing the reset (*RST*) button for a given time, see the technical manual of the router for more information. This action will revert all the configuration settings to the factory defaults and the router will reboot (the *PWR* LED will be on during the reboot).

2.2 HTTPS Certificate for the GUI

There is the self-signed HTTPS certificate in the router. Because the identity of this certificate cannot be validated, a message can appear in the web browser. To solve this, upload your own certificate, signed by Certification Authority, to the router. If you want to use your

own certificate (e.g. in combination with the dynamic DNS service), you need to replace the `/etc/certs/https_cert` and `/etc/certs/https_key` files in the router. This can be done easily in the GUI on *HTTP* configuration page, see Chapter 4.15.3.

If you decide to use the self-signed certificate in the router to prevent the security message (domain disagreement) from pop up every time you log into the router, you can take the following steps:

- Add the DNS record to your [DNS](#) system: Edit `/etc/hosts` (Linux/Unix OS) or `C:\WINDOWS\system32\drivers\etc\hosts` (Windows OS) or configure your own DNS server. Add a new record with the IP address of your router and the domain name based of the MAC address of the router (MAC address of the first network interface seen in *Network Status* in the Web interface of the router.) Use dash separators instead of colons. Example: A router with the MAC address 00:11:22:33:44:55 will have a domain name 00-11-22-33-44-55.
- Access the router via the new domain name address (E.g. `https://00-11-22-33-44-55`). If you see the security message, add an exception so the next time the message will not pop up (E.g. in Firefox Web browser). If there is no possibility to add an exception, export the certificate to the file and import it to your browser or operating system.

Note: You will have to use the domain name based on the MAC address of the router and it is not guaranteed to work with every combination of an operating system and a browser.

2.3 Valid Characters

If the router is configured through the web interface, avoid entering forbidden characters into any of the input forms (not just for password). Valid and forbidden characters are specified below. Please note that the "space" character may not be allowed for some forms as well.

Valid characters are: 0-9 a-z A-Z * , + - . / : = ? ! # % @ [] _ { } ~

Forbidden characters are: “ \$ & ’ () ; < > \ ^ ‘ |

3. Status

3.1 General Status

You can reach a summary of basic router information and its activities by opening the *General* status page. This page is displayed when you log in to the device by default. The information displayed on this page is divided into several sections, based upon the type of the router and its hardware configuration. Typically, there are sections for the mobile connection, LAN, system information, and eventually for the WiFi and peripheral ports, if the device is equipped with.



IPv6 Address item can show multiple different addresses for one network interface. This is standard behavior since an IPv6 interface uses more addresses. The second IPv6 Address showed after pressing *More Information* is automatically generated EUI-64 format link local IPv6 address derived from MAC address of the interface. It is generated and assigned the first time the interface is used (e.g. cable is connected, Mobile WAN connecting, etc.).

3.1.1 Mobile Connection

| Item | Description |
|-------------|--|
| SIM Card | Identification of the SIM card |
| Interface | Defines the interface |
| Flags | Displays network interface flags: None - no flags Up - the interface is administratively enabled Running - the interface is in operational state (cable detected) Multicast - the interface is capable of multicast transmission |
| IP Address | IP address of the interface |
| MTU | Maximum packet size that the equipment is able to transmit |
| Rx Data | Total number of received bytes |
| Rx Packets | Received packets |
| Rx Errors | Erroneous received packets |
| Rx Dropped | Dropped received packets |
| Rx Overruns | Lost received packets because of overload |
| Tx Data | Total number of sent bytes |
| Tx Packets | Sent packets |
| Tx Errors | Erroneous sent packets |
| Tx Dropped | Dropped sent packets |

Continued on next page

Continued from previous page

| Item | Description |
|-------------|--|
| Tx Overruns | Lost sent packets because of overload |
| Uptime | Indicates how long the connection to the cellular network has been established |

Table 1: Mobile Connection

3.1.2 Ethernet Status

Every Ethernet interface has its separate section on the *General* status page. Items displayed here have the same meaning as items in the previous part. Moreover, the *MAC Address* item shows the MAC address of the corresponding router's interface. Visible information depends on the Ethernet configuration, see Chapter 4.1.

3.1.3 Peripheral Ports

| Item | Description |
|-------------------------------|---|
| Expansion Port 1 ¹ | An interface detected on the first expansion port. |
| Expansion Port 2 ¹ | An interface detected on the second expansion port. |
| Binary Input | State of the binary input. |
| Binary Output | State of the binary output. |

Table 2: Peripheral Ports

3.1.4 System Information

System information about the device is displayed in the *System Information* section.

| Item | Description |
|------------------|---|
| Firmware Version | Information about the firmware version |
| Serial Number | Serial number of the router (in case of <i>N/A</i> is not available) |
| Hardware UUID | Unique HW identifier for the device. |
| Profile | Current profile – standard or alternative profiles (profiles are used for example to switch between different modes of operation) |
| Time | Current date and time |
| Uptime | Indicates how long the router is used |

Continued on next page

¹If the device is equipped with.

Continued from previous page

| Item | Description |
|----------|--|
| Licenses | Link to the list of open source software components of the firmware together with their complete license texts (GPL versions 2 and 3, LGPL version 2, BSD-style licenses, MIT-style licenses). |

Table 3: System Information

3.2 Mobile WAN Status

The *Mobile WAN* menu item contains current information about connections to the mobile network. The first part of this page (*Mobile Network Information*) displays basic information about mobile network the router operates in. There is also information about the module, which is mounted in the router.

| Item | Description |
|-----------------|--|
| Registration | State of the network registration |
| Operator | Specifies the operator's network the router operates in. |
| Technology | Transmission technology |
| PLMN | Code of operator |
| Cell | Cell the router is connected to (in hexadecimal format). |
| LAC/TAC | Unique number (in hexadecimal format) assigned to each location area. LAC (Location Area Code) is for 2G/3G networks and TAC (Tracking Area Code) is for 4G networks. |
| Channel | Channel the router communicates on <ul style="list-style-type: none"> • ARFCN in case of GPRS/EDGE technology, • UARFCN in case of UMTS/HSPA technology, • EARFCN in case of LTE technology. |
| Band | Cellular band abbreviation. |
| Signal Strength | Signal strength (in dBm) of the selected cell, for details see Table 5. |
| Signal Quality | Signal quality of the selected cell: <ul style="list-style-type: none"> • EC/IO for UMTS (it's the ratio of the signal received from the pilot channel – EC – to the overall level of the spectral density, ie the sum of the signals of other cells – IO). • RSRQ for LTE technology (Defined as the ratio $\frac{N \times RSRP}{RSSI}$). • The value is not available for the EDGE technology. |

Continued on next page

¹If a neighboring cell for GPRS is highlighted in red, router may repeatedly switch between the neighboring and the primary cell affecting the router's performance. To prevent this, re-orient the antenna or use a directional antenna.

Continued from previous page

| Item | Description |
|---------------------------------------|---|
| RSSI, RSRP, RSRQ, SINR, RSCP or Ec/Io | Other parameters reporting signal strength or quality. Please note, that some of them may not be available, depending on the cellular module or cellular technology. |
| CSQ | Cell signal strength with following value ranges: <ul style="list-style-type: none"> • 2 – 9 = Marginal, • 10 – 14 = OK, • 15 – 19 = Good, • 20 – 30 = Excellent. |
| Neighbours | Signal strength of neighboring hearing cells (GPRS only) ¹ . |
| Manufacturer | Module manufacturer |
| Model | Type of module |
| Revision | Revision of module |
| IMEI | IMEI (International Mobile Equipment Identity) number of module |
| MEID | MEID number of module |
| ICCID | Integrated Circuit Card Identifier is international and unique serial number of the SIM card. |

Table 4: Mobile Network Information

The value of signal strength is displayed in different color: in black for good, in orange for fair and in red for poor signal strength.

| Signal strength | GPRS/EDGE/CDMA (RSSI) | UMTS/HSPA (RSCP) | LTE (RSRP) |
|-----------------|-----------------------|--------------------|---------------------|
| good | > -70 dBm | > -75 dBm | > -90 dBm |
| fair | -70 dBm to -89 dBm | -75 dBm to -94 dBm | -90 dBm to -109 dBm |
| poor | < -89 dBm | < -94 dBm | < -109 dBm |

Table 5: Value ranges of signal strength for different technologies.

The middle part of this page displays information about mobile signal quality, transferred data and number of connections for all the SIM cards (for each period). The router has standard intervals, such as the previous 24 hours and last week, and also period starting with *Accounting Start* defined for the MWAN module.



Tips for *Mobile Network Statistics* table:

- *Availability* is expressed as a percentage. It is the ratio of time connection to the mobile network has been established to the time that router has been is turned on.
- Placing your cursor over the maximum or minimum signal strength will display the last time the router reached that signal strength.

| Period | Description |
|---------------|--|
| Today | Today from 0:00 to 23:59 |
| Yesterday | Yesterday from 0:00 to 23:59 |
| This week | This week from Monday 0:00 to Sunday 23:59 |
| Last week | Last week from Monday 0:00 to Sunday 23:59 |
| This period | This accounting period |
| Last period | Last accounting period |

Table 6: Description of Periods

The last part (*Connection Log*) displays information about the mobile network connections and any problems that occurred while establishing them.

| Item | Description |
|--------------|---|
| RX data | Total volume of received data |
| TX data | Total volume of sent data |
| Connections | Number of connection to mobile network establishment |
| Signal Min | Minimal signal strength |
| Signal Avg | Average signal strength |
| Signal Max | Maximal signal strength |
| Cells | Number of switch between cells |
| Availability | Availability of the router via the mobile network (expressed as a percentage) |

Table 7: Mobile Network Statistics

| Mobile WAN Status | | | | | | |
|---|----------------|-----------|-----------|-----------|-------------|-------------|
| Mobile Network Information | | | | | | |
| Registration | : Home Network | | | | | |
| Operator | : Vodafone | | | | | |
| Technology | : LTE | | | | | |
| PLMN | : 23003 | | | | | |
| Cell | : 10A80C | | | | | |
| LAC | : 947C | | | | | |
| Channel | : 6400 | | | | | |
| Signal Strength | : -71 dBm | | | | | |
| Signal Quality | : -7 dB | | | | | |
| » More Information « | | | | | | |
| Statistics for 1st SIM card | | | | | | |
| | Today | Yesterday | This Week | Last Week | This Period | Last Period |
| Rx Data | : 0 KB | 24 KB | 24 KB | 0 KB | 24 KB | 0 KB |
| Tx Data | : 0 KB | 908 KB | 908 KB | 0 KB | 908 KB | 0 KB |
| Connections | : 0 | 6 | 6 | 0 | 6 | 0 |
| Signal Min | : -74 dBm | -73 dBm | -74 dBm | ? | -74 dBm | ? |
| Signal Avg | : -72 dBm | -71 dBm | -72 dBm | ? | -72 dBm | ? |
| Signal Max | : -71 dBm | -71 dBm | -71 dBm | ? | -71 dBm | ? |
| Cells | : 1 | 1 | 1 | 0 | 1 | 0 |
| Availability | : 100.0% | 99.2% | 99.8% | 0.0% | 99.8% | 0.0% |
| Statistics for 2nd SIM card | | | | | | |
| | Today | Yesterday | This Week | Last Week | This Period | Last Period |
| Rx Data | : 0 KB | 0 KB | 0 KB | 0 KB | 0 KB | 0 KB |
| Tx Data | : 0 KB | 0 KB | 0 KB | 0 KB | 0 KB | 0 KB |
| Connections | : 0 | 0 | 0 | 0 | 0 | 0 |
| Signal Min | : ? | ? | ? | ? | ? | ? |
| Signal Avg | : ? | ? | ? | ? | ? | ? |
| Signal Max | : ? | ? | ? | ? | ? | ? |
| Cells | : 0 | 0 | 0 | 0 | 0 | 0 |
| Availability | : 0.0% | 0.0% | 0.0% | 0.0% | 0.0% | 0.0% |
| Connection Log | | | | | | |
| 2019-08-21 23:20:07 (1st SIM card) Connection successfully established. | | | | | | |

Figure 2: Mobile WAN status

3.3 Network Status

To view information about the interfaces and the routing table, open the *Network* item in the *Status* menu. The upper part of the window displays detailed information about the active interfaces only:

| Interface | Description |
|------------|---|
| eth0, eth1 | First and second network (Ethernet) interfaces |
| lo | Local loopback interface |
| nat64 | Network interface of internal translator gateway between IPv6 and IPv4 addresses. |
| usb0 | Active PPP connection to the mobile network – wireless module is connected via USB interface. |
| ppp0 | PPP interface (e.g. PPPoE tunnel) |
| tun0 | OpenVPN tunnel interface – if configured |
| ipsec0 | IPSec tunnel interface – if configured |
| gre1 | GRE tunnel interface – if configured |
| wg1 | WireGuard tunnel interface – if configured |

Table 8: Description of Interfaces in Network Status

The following information can be displayed for every network interface:

| Item | Description |
|------------|--|
| HWaddr | Hardware (unique, MAC) address of a network interface. |
| inet addr | IPv4 address of interface |
| inet6 addr | IPv6 address of interface. There can be more of them for single network interface. |
| P-t-P | IP address of the opposite end (in case of point-to-point connection). |
| Bcast | Broadcast address |
| Mask | Mask of network |
| MTU | Maximum packet size that the equipment is able to transmit. |
| Metric | Number of routers the packet must go through. |

Continued on next page

Continued from previous page

| Item | Description |
|------------|---|
| RX | <ul style="list-style-type: none"> • packets – received packets • errors – number of errors • dropped – dropped packets • overruns – incoming packets lost because of overload. • frame – wrong incoming packets because of incorrect packet size. |
| TX | <ul style="list-style-type: none"> • packets – transmit packets • errors – number of errors • dropped – dropped packets • overruns – outgoing packets lost because of overload. • carrier – wrong outgoing packets with errors resulting from the physical layer. |
| collisions | Number of collisions on physical layer. |
| txqueuelen | Length of buffer (queue) of the network interface. |
| RX bytes | Total number of received bytes. |
| TX bytes | Total number of transmitted bytes. |

Table 9: Description of Information in Network Status

You may view the status of the mobile network connection on the network status screen. If the connection to the mobile network is active, it will appear in the system information as an usb0 interface.

The *Route Table* is displayed at the bottom of the *Network Status* page. There is *IPv4 Route Table* and *IPv6 Route Table* below.

If the router is connected to the Internet (a default route is defined), the *nat64* network interface is created automatically. This is the NAT64 internal gateway for translating the IPv6 and IPv4 communication. It is used automatically when connected via IPv6 and communicating with IPv4 device or network. It works together with DNS64 running in the router automatically (translation of domain names to IP addresses). The default NAT64 prefix 64:ff9b::/96 is used as you can see in Figure 3 below in the *IPv6 Route Table* section.

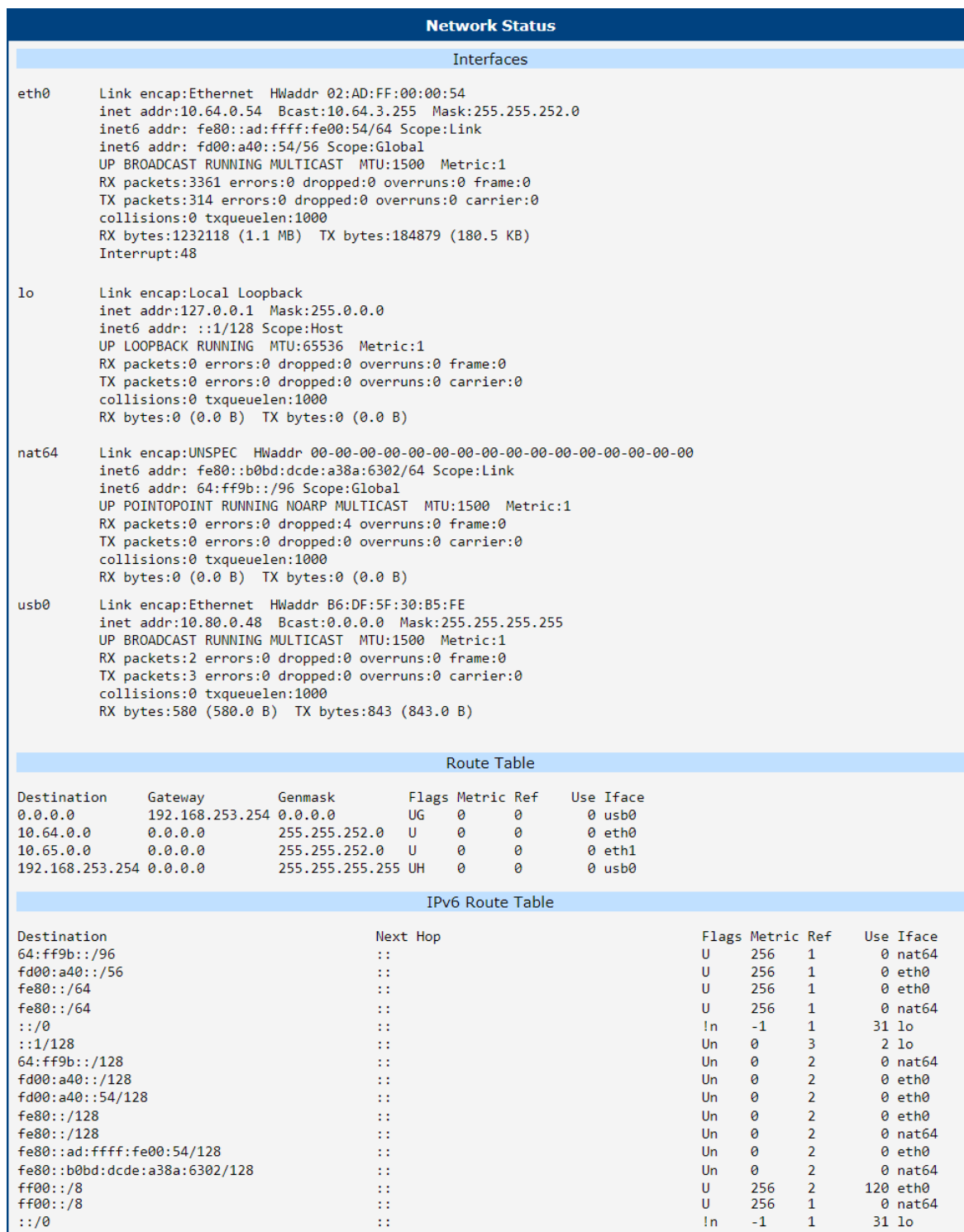

Figure 3: Network Status

3.4 DHCP Status

Information about the DHCP server activity is accessible via *DHCP* item. The DHCP server provides automatic configuration of the client devices connected to the router. The DHCP server assigns each device an IP address, subnet mask, default gateway (IP address of router) and DNS server (IP address of router). DHCPv6 server is supported.

```

DHCP Status
Active DHCP Leases (LAN)
lease 192.168.10.20 {
  starts epoch 946708441; # Sat Jan 01 06:34:01 2000
  ends epoch 946708501; # Sat Jan 01 06:35:01 2000
  tstp epoch 946708501; # Sat Jan 01 06:35:01 2000
  cltt epoch 946708441; # Sat Jan 01 06:34:01 2000
  binding state free;
  hardware ethernet 00:0a:14:82:df:f9;
}

Active DHCPv6 Leases (LAN)
ia-na "\001\000\000\000\000\000\003\000\001\000\012\024\202\337\371" {
  cltt epoch 946713997; # Sat Jan 01 08:06:37 2000
  iaaddr fd00:1233::2a {
    binding state active;
    preferred-life 375;
    max-life 600;
    ends epoch 946714597; # Sat Jan 01 08:16:37 2000
  }
}
    
```

Figure 4: DHCP Status



The DHCP status may occasionally display two records for one IP address. This may be caused by resetting the client network interface.

Records in the *DHCP Status* window are divided into two separate parts according to IPv4 (DHCP) and IPv6 (DHCPv6) protocols – there are *Active DHCP Leases (LAN)* and *Active DHCPv6 Leases (LAN)* parts, see Figure 4. The table below explains information from the client list:

| Item | Description |
|--------------------|---|
| lease | Assigned IPv4 address. |
| iaaddr | (IPv6) Assigned IPv6 address. |
| starts epoch | Time that the IP address was assigned. |
| ends epoch | Time that the IP address lease expires. |
| tstp epoch | What time the peer has been told the lease expires. |
| cltt epoch | Client last transaction time. |
| binding state | The lease's binding state. |
| next binding state | What state the lease will move to when the current state expires. |
| hardware ethernet | Unique hardware MAC address. |
| uid | Unique ID. |
| client-hostname | Host computer name. |
| preferred-life | (IPv6) Length of time the address can be used without any restrictions. When the preferred-life expires, the address should not be used for new communications, but might continue to be used for existing communications in certain cases. |
| max-life | (IPv6) Maximum time for which the DHCPv6 server can grant a lease. |

Table 10: DHCP Status Description for IPv4 and IPv6 leases

3.5 IPsec Status

Selecting the *IPsec* option in the *Status* menu of the web page will bring up the information for any IPsec Tunnels that have been established. If the tunnel has been built correctly, the screen will display **ESTABLISHED** and the number of running IPsec connections **1 up** (orange highlighted in the figure below.) If there is no such text in log (e.g. "0 up"), the tunnel was not created!

```

IPsec Status
IPsec Tunnels Information
Status of IKE charon daemon (weakSwan 5.5.3, Linux 3.12.10+, armv7l):
uptime: 26 minutes, since Nov 09 10:26:10 2017
malloc: sbrk 528384, mmap 0, used 123104, free 405280
worker threads: 11 of 16 idle, 5/0/0/0 working, job queue: 0/0/0/0, scheduled: 5
loaded plugins: charon nonce pem openssl kernel-netlink socket-default stroke updown
Listening IP addresses:
192.168.1.1
2001:10:7:6::1
10.0.0.228
Connections:
ipsecl: 10.0.0.228...%any IKEv2, dpddelay=20s
ipsecl: local: [10.0.0.228] uses pre-shared key authentication
ipsecl: remote: uses pre-shared key authentication
ipsecl: child: 2001:10:7:6::/64 == 1999:10:7:5::/64 TUNNEL, dodaction=clear
Security Associations (1 up, 0 connecting):
ipsecl{2}: ESTABLISHED 17 minutes ago, 10.0.0.228[10.0.0.228]...10.0.2.250[10.0.2.250]
ipsecl{2}: IKEv2 SPIs: 7e675f07f05d7434_i 8625de2fc6f84049_r*, pre-shared key reauthentication in 28 minutes
ipsecl{2}: IKE proposal: AES_CBC_128/HMAC_SHA2_256_128/PRF_HMAC_SHA2_256/MODP_3072
ipsecl{2}: INSTALLED, TUNNEL, reqid 2, ESP SPIs: c7247a03_i c29f5287_o
ipsecl{2}: AES_CBC_128/HMAC_SHA1_96, 0 bytes_i, 0 bytes_o, rekeying in 30 minutes
ipsecl{2}: 2001:10:7:6::/64 == 1999:10:7:5::/64
    
```

Figure 5: IPsec Status

3.6 WireGuard Status

Selecting the *WireGuard* option in the *Status* menu of the web page will bring up the information for any WireGuard Tunnels established. In the figure below is an example of the first WireGuard tunnel running.

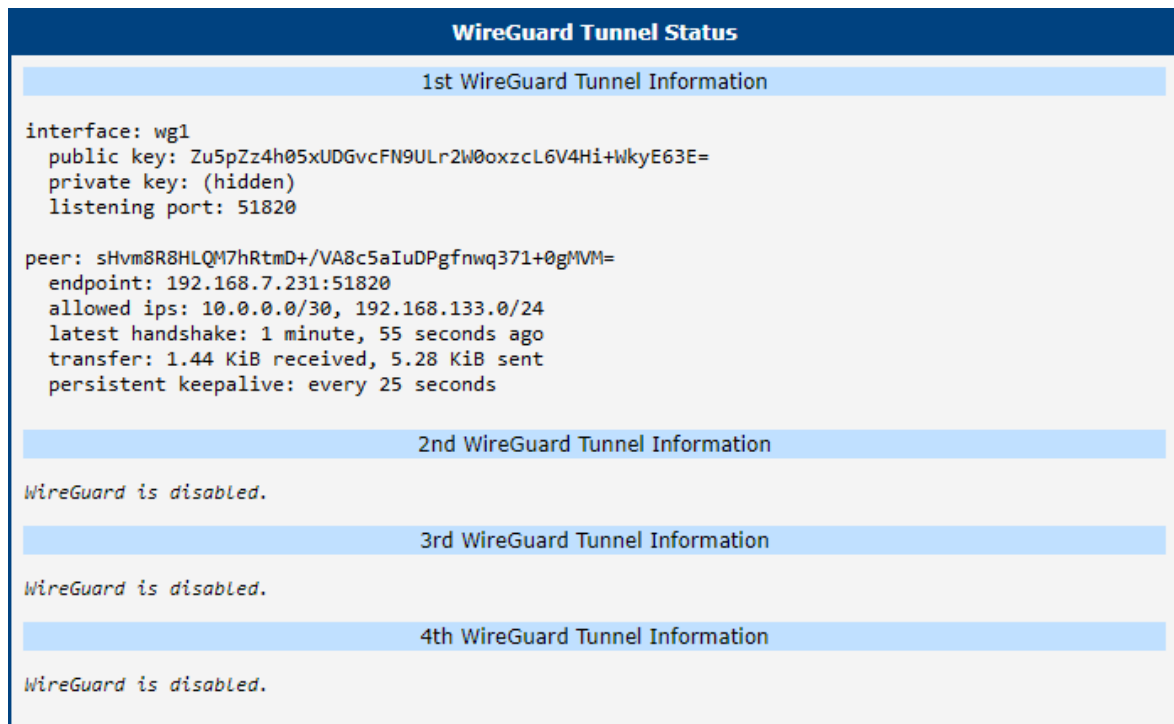

Figure 6: WireGuard Status Page



The *Latest handshake* time is the time left from the latest successful communication with the opposite tunnel side. This item will not be shown here until there is a tunnel communication (data sent by the client-side or the keepalive data sent when *NAT/Firewall Traversal* is set to yes).

3.7 DynDNS Status

The router supports DynamicDNS using a DNS server on www.dyndns.org. If Dynamic DNS is configured, the status can be displayed by selecting menu option DynDNS. Refer to www.dyndns.org for more information on how to configure a Dynamic DNS client.



You can use the following listed servers for the Dynamic DNS service. It is possible to use the DynDNSv6 service with *IP Mode* switched to IPv6 on *DynDNS Configuration* page.

- www.dyndns.org
- www.spdns.de
- www.dnsdynamic.org
- www.noip.com

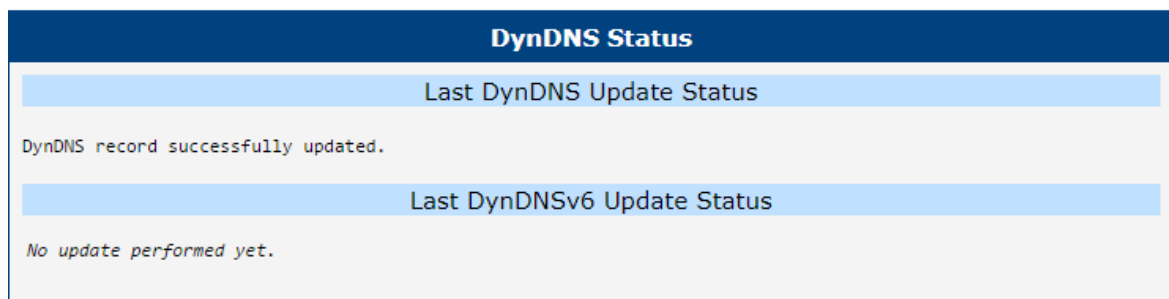

Figure 7: DynDNS Status

When the router detects a DynDNS record update, the dialog displays one or more of the following messages:

- DynDNS client is disabled.
- Invalid username or password.
- Specified hostname doesn't exist.
- Invalid hostname format.
- Hostname exists, but not under specified username.
- No update performed yet.
- DynDNS record is already up to date.
- DynDNS record successfully update.
- DNS error encountered.
- DynDNS server failure.



The router's SIM card must have public IP address assigned or DynDNS will not function correctly.

3.8 System Log

If there are any connection problems you may view the system log by selecting the *System Log* menu item. Detailed reports from individual applications running in the router will be displayed. Use the *Save Log* button to save the system log to a connected computer. (It will be saved as a text file with the .log extension.) The *Save Report* button is used for creating detailed reports. (It will be saved as a text file with the .txt extension. The file will include statistical data, routing and process tables, system log, and configuration.)



Sensitive data from the report are filtered out for security reasons.

The default length of the system log is 1000 lines. After reaching 1000 lines a new file is created for storing the system log. After completion of 1000 lines in the second file, the first file is overwritten with a new file.

The *Syslogd* program will output the system log. It can be started with two options to modify its behavior. Option *"-S"* followed by decimal number sets the maximal number of lines in one log file. Option *"-R"* followed by hostname or IP address enables logging to a remote syslog daemon. (If the remote syslog daemon is Linux OS, there has to be remote logging enabled (typically running *"syslogd -R"*). If it's the Windows OS, there has to be syslog server installed, e.g. *Syslog Watcher*). To start *syslogd* with these options, the *"/etc/init.d/syslog"* script can be modified via SSH or lines can be added into *Startup Script* (accessible in *Configuration* section) according to figure 9.

System Log

System Messages

```

2013-07-02 12:46:14 System log daemon started.
2013-07-02 12:46:19 pppsd[426]: pppsd started
2013-07-02 12:46:19 pppsd[426]: module is turned on
2013-07-02 12:46:19 pppsd[426]: selected SIM: 1st
2013-07-02 12:46:19 dnsmasq[453]: started, version 2.59 cachesize 150
2013-07-02 12:46:19 dnsmasq[453]: cleared cache
2013-07-02 12:46:19 bard[455]: bard started
2013-07-02 12:46:19 pppsd[426]: selected APN: connection.com
2013-07-02 12:46:19 pppsd[426]: waiting for registration
2013-07-02 12:46:20 pppsd[426]: starting usbd
2013-07-02 12:46:20 usbd[500]: usbd started
2013-07-02 12:46:20 usbd[500]: establishing connection
2013-07-02 12:46:20 sshd[506]: Server listening on 0.0.0.0 port 22.
2013-07-02 12:46:29 usbd[500]: connection established
2013-07-02 12:46:29 usbd[500]: local IP address 10.0.1.229
2013-07-02 12:46:29 usbd[500]: primary DNS address 10.0.0.1
2013-07-02 12:46:29 bard[455]: backup route selected: "Mobile WAN"
2013-07-02 12:46:29 bard[455]: script /etc/scripts/ip-up started
2013-07-02 12:46:30 bard[455]: script /etc/scripts/ip-up finished, status = 0x0
2013-07-02 12:46:31 dnsmasq[453]: reading /etc/resolv.conf
2013-07-02 12:46:31 dnsmasq[453]: using nameserver 10.0.0.1#53
                
```

Save Log
Save Report

Figure 8: System Log

The following example (figure) shows how to send syslog information to a remote server at 192.168.2.115 on startup.

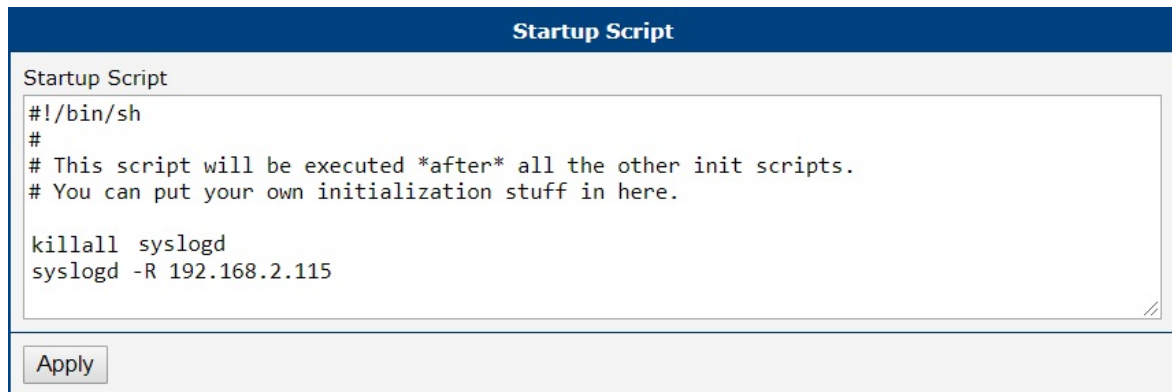

The screenshot shows a window titled "Startup Script" with a text area containing the following script:

```
Startup Script
#!/bin/sh
#
# This script will be executed *after* all the other init scripts.
# You can put your own initialization stuff in here.

killall syslogd
syslogd -R 192.168.2.115
```

Below the text area is an "Apply" button.

Figure 9: Example program syslogd start with the parameter -R

4. Configuration

4.1 Ethernet Configuration

To enter the Local Area Network configuration, select the *Ethernet* menu item in the *Configuration* section. The *Ethernet* item will expand in the menu on the left, so you can choose the proper Ethernet interface to configure: *ETH0* for the first Ethernet interface and *ETH1* for the second Ethernet interface .

LAN Configuration page is divided into IPv4 and IPv6 columns, see Figure 10. There is dual stack support of IPv4 and IPv6 protocols – they can run alongside, you can configure either one of them or both. If you configure both IPv4 and IPv6, other network devices will choose the communication protocol. Configuration items and IPv6 to IPv4 differences are described in the tables below.

| ETH0 Configuration | | |
|--|-------------------|--------------|
| | IPv4 | IPv6 |
| DHCP Client | disabled | disabled |
| IP Address | 10.64.0.37 | fc00::a40:37 |
| Subnet Mask / Prefix | 255.255.252.0 | 118 |
| Default Gateway | | |
| DNS Server | | |
| Bridged | no | |
| Media Type | auto-negotiation | |
| <input type="checkbox"/> Enable dynamic DHCP leases | | |
| IP Pool Start | | |
| IP Pool End | | |
| Lease Time | | sec |
| <input type="checkbox"/> Enable static DHCP leases | | |
| MAC Address | IP Address | IPv6 Address |
| | | |
| | | |
| | | |
| | | |
| <input type="checkbox"/> Enable IPv6 prefix delegation | | |
| Subnet ID * | | |
| Subnet ID Width * | | bits |
| <input type="checkbox"/> Enable IEEE 802.1X Authentication | | |
| Authentication Method | EAP-PEAP/MSCHAPv2 | |
| CA Certificate | | |
| Local Certificate | | |
| Local Private Key | | |
| Identity | | |
| Password | | |
| * can be blank | | |
| Apply | | |

Figure 10: LAN Configuration page

| Item | Description |
|----------------------|--|
| DHCP Client | <p>Enables/disables the DHCP client function. If in IPv6 column, the DHCPv6 client is enabled. DHCPv6 client supports all three methods of getting an IPv6 address – SLAAC, stateless DHCPv6 and statefull DHCPv6.</p> <ul style="list-style-type: none"> • disabled – The router does not allow automatic allocation of an IP address from a DHCP server in LAN network. • enabled – The router allows automatic allocation of an IP address from a DHCP server in LAN network. |
| IP Address | A fixed IP address of the Ethernet interface. Use IPv4 notation in IPv4 column and IPv6 notation in IPv6 column. Shortened IPv6 notation is supported. |
| Subnet Mask / Prefix | Specifies a Subnet Mask for the IPv4 address. In the IPv6 column, fill in the Prefix for the IPv6 address – number in range 0 to 128. |
| Default Gateway | Specifies the IP address of a default gateway. If filled-in, every packet with the destination not found in the routing table is sent to this IP address. Use proper IP address notation in IPv4 and IPv6 column. |
| DNS Server | Specifies the IP address of the DNS server. When the IP address is not found in the Routing Table, the router forwards the request to DNS server specified here. Use proper IP address notation in IPv4 and IPv6 column. |

Table 11: Configuration of the Network Interface – IPv4 and IPv6

The *Default Gateway* and *DNS Server* items are only used if the *DHCP Client* item is set to *disabled* and if the ETH0 or ETH1 LAN is selected by the *Backup Routes* system as the default route. (The selection algorithm is described in section 4.5). Since FW 5.3.0, *Default Gateway* and *DNS Server* are also supported on bridged interfaces (e.g. eth0 + eth1).

The following three items (in the table below) are global for the configured Ethernet interface. Only one bridge can be active on the router at a time. The *DHCP Client*, *IP Address* and *Subnet Mask / Prefix* parameters of the only one of the interfaces are used to for the bridge. ETH0 LAN has higher priority when both interfaces (ETH0, ETH1) are added to the bridge. Other interfaces can be added to or deleted from an existing bridge at any time. The bridge can be created on demand for such interfaces, but not if it is configured by their respective parameters.

| Item | Description |
|------------|---|
| Bridged | <p>Activates/deactivates the bridging function on the router.</p> <ul style="list-style-type: none"> • no – The bridging function is inactive (default). • yes – The bridging function is active. |
| Media Type | <p>Specifies the type of duplex and speed used in the network.</p> <ul style="list-style-type: none"> • Auto-negation – The router automatically sets the best speed and duplex mode of communication according to the network’s possibilities. • 100 Mbps Full Duplex – The router communicates at 100 Mbps, in the full duplex mode. • 100 Mbps Half Duplex – The router communicates at 100 Mbps, in the half duplex mode. • 10 Mbps Full Duplex – The router communicates at 10 Mbps, in the full duplex mode. • 10 Mbps Half Duplex – The router communicates at 10 Mbps, in the half duplex mode. |
| PoE PSE | <ul style="list-style-type: none"> • enabled – The router provides power on the Ethernet cable. • disabled – The router does not provide power on the Ethernet cable (default). |

Table 12: Configuration of the Network Interface – global items

4.1.1 DHCP Server

The DHCP server assigns the IP address, gateway IP address (IP address of the router) and IP address of the DNS server (IP address of the router) to the connected clients. If these values are filled in by the user in the configuration form, they will be preferred.

The DHCP server supports static and dynamic assignment of IP addresses. *Dynamic DHCP* assigns clients IP addresses from a defined address space. *Static DHCP* assigns IP addresses that correspond to the MAC addresses of connected clients.

If IPv6 column is filled in, the DHCPv6 server is used. DHCPv6 server offers stateful address configuration to connected clients. Only when the *Subnet Prefix* above is set to 64, the DHCPv6 server offers both – the stateful address configuration and SLAAC (Stateless Address Autoconfiguration).





Do not to overlap ranges of static allocated IP addresses with addresses allocated by the dynamic DHCP server. IP address conflicts and incorrect network function can occur if you overlap the ranges.

| Item | Description |
|----------------------------|--|
| Enable dynamic DHCP leases | Select this option to enable a dynamic DHCP server. |
| IP Pool Start | Starting IP addresses allocated to the DHCP clients. Use proper notation in IPv4 and IPv6 column. |
| IP Pool End | End of IP addresses allocated to the DHCP clients. Use proper IP address notation in IPv4 and IPv6 column. |
| Lease time | Time in seconds that the IP address is reserved before it can be re-used. |

Table 13: Configuration of Dynamic DHCP Server

| Item | Description |
|---------------------------|--|
| Enable static DHCP leases | Select this option to enable a static DHCP server. |
| MAC Address | MAC address of a DHCP client. |
| IPv4 Address | Assigned IPv4 address. Use proper notation. |
| IPv6 Address | Assigned IPv6 address. Use proper notation. |

Table 14: Configuration of Static DHCP Server

4.1.2 IPv6 Prefix Delegation



This is an advanced configuration option. IPv6 prefix delegation works automatically with DHCPv6 – use only if different configuration is desired and if you know the consequences.

If you want to override the automatic IPv6 prefix delegation, you can configure it in this form. You have to know your Subnet ID Width (part of IPv6 address), see Figure below for the calculation help – it is an example: 48 bits is Site Prefix, 16 bits is Subnet ID (*Subnet ID Width*) and 64 bits is Interface ID.

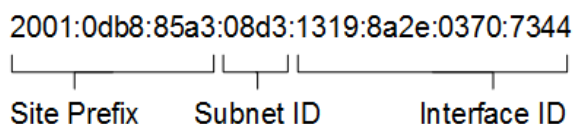

Figure 11: IPv6 Address with Prefix Example

| Item | Description |
|-------------------------------|---|
| Enable IPv6 prefix delegation | Enables prefix delegation configuration filled-in below. |
| Subnet ID | The decimal value of the Subnet ID of the Ethernet interface. Maximum value depends on the <i>Subnet ID Width</i> . |
| Subnet ID Width | The maximum <i>Subnet ID Width</i> depends on your Site Prefix – it is the remainder to 64 bits. |

Table 15: IPv6 prefix delegation configuration

4.1.3 802.1X Authentication to RADIUS Server

Authentication (802.1X) to RADIUS server can be enabled in next configuration section. The router can be RADIUS client only (not the server). This functionality requires additional setting of identity and certificates as described in the following table.

| Item | Description |
|-----------------------------------|---|
| Enable IEEE 802.1X Authentication | Select this option to enable 802.1X Authentication. |
| Authentication Method | Select authentication method (EAP-PEAPMSCHAPv2 or EAP-TLS). |
| CA Certificate | Definition of CA certificate for EAP-TLS authentication protocol. |
| Local Certificate | Definition of local certificate for EAP-TLS authentication protocol. |
| Local Private Key | Definition of local private key for EAP-TLS authentication protocol. |
| Identity | User name – identity. |
| Password | Access password. This item is available for EAP-PEAPMSCHAPv2 protocol only. Enter valid characters only, see chap. 2.3! |
| Local Private Key Password | Definition of password for private key of EAP-TLS protocol. This item is available for EAP-TLS protocol only. Enter valid characters only, see chap. 2.3! |

Table 16: Configuration of 802.1X Authentication

4.1.4 LAN Configuration Examples

Example 1: IPv4 Dynamic DHCP Server, Default Gateway and DNS Server

- The range of dynamic allocated IPv4 addresses is from 192.168.1.2 to 192.168.1.4.
- The address is allocated for 600 second (10 minutes).
- Default gateway IP address is 192.168.1.20
- DNS server IP address is 192.168.1.20

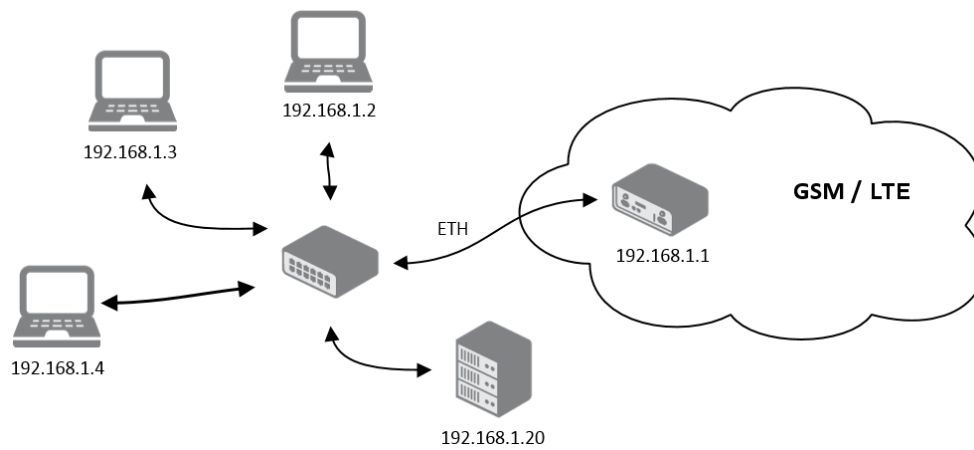

Figure 12: Network Topology for Example 1

| ETH0 Configuration | | |
|--|---|--------------------|
| DHCP Client | IPv4 disabled ▼ | IPv6 disabled ▼ |
| IP Address | 192.168.1.1 | |
| Subnet Mask / Prefix | 255.255.255.0 | |
| Default Gateway | 129.168.1.20 | |
| DNS Server | 192.168.1.20 | |
| Bridged | no ▼ | |
| Media Type | auto-negotiation ▼ | |
| <input checked="" type="checkbox"/> Enable dynamic DHCP leases | | |
| IP Pool Start | IPv4 192.168.1.2 | IPv6 |
| IP Pool End | 192.168.1.4 | |
| Lease Time | 600 | 600 sec |
| <input type="checkbox"/> Enable static DHCP leases | | |
| MAC Address | IP Address | IPv6 Address |
| | | |
| | | |
| | | |
| | | |
| | | |
| | | |
| <input type="checkbox"/> Enable IPv6 prefix delegation | | |
| Subnet ID * | | |
| Subnet ID Width * | | bits |
| <input type="checkbox"/> Enable IEEE 802.1X Authentication | | |
| Authentication Method | EAP-PEAP/MSCHAPv2 ▼ | |
| CA Certificate | <input type="text"/> <input type="button" value="Choose File"/> No file chosen | |
| Local Certificate | <input type="text"/> <input type="button" value="Choose File"/> No file chosen | |
| Local Private Key | <input type="text"/> <input type="button" value="Choose File"/> No file chosen | |
| Identity | <input type="text"/> | |
| Password | <input type="text"/> | |
| * can be blank | | |
| <input type="button" value="Apply"/> | | |

Figure 13: LAN Configuration for Example 1

Example 2: IPv4 Dynamic and Static DHCP server

- The range of allocated addresses is from 192.168.1.2 to 192.168.1.4.
- The address is allocated for 600 seconds (10 minutes).
- The client with the MAC address 01:23:45:67:89:ab has the IP address 192.168.1.10.
- The client with the MAC address 01:54:68:18:ba:7e has the IP address 192.168.1.11.

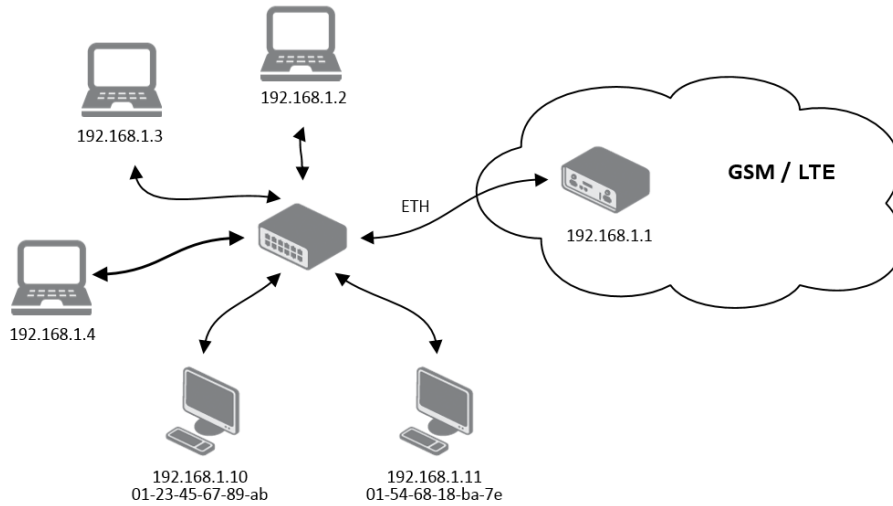

Figure 14: Network Topology for Example 2

| ETH0 Configuration | | |
|--|----------------------------|--------------------|
| DHCP Client | IPv4 disabled ▼ | IPv6 disabled ▼ |
| IP Address | 192.168.1.1 | |
| Subnet Mask / Prefix | 255.255.255.0 | |
| Default Gateway | | |
| DNS Server | | |
| Bridged | no ▼ | |
| Media Type | auto-negotiation ▼ | |
| <input checked="" type="checkbox"/> Enable dynamic DHCP leases | | |
| IP Pool Start | IPv4 192.168.1.2 | IPv6 |
| IP Pool End | 192.168.1.4 | |
| Lease Time | 600 | 600 sec |
| <input checked="" type="checkbox"/> Enable static DHCP leases | | |
| MAC Address | IP Address | IPv6 Address |
| 01:23:45:67:89:ab | 192.168.1.10 | |
| 01:54:68:18:ba:7e | 192.168.1.11 | |
| | | |
| | | |
| | | |
| | | |
| <input type="checkbox"/> Enable IPv6 prefix delegation | | |
| Subnet ID * | | |
| Subnet ID Width * | | bits |
| <input type="checkbox"/> Enable IEEE 802.1X Authentication | | |
| Authentication Method | EAP-TLS ▼ | |
| CA Certificate | <input type="text"/> | |
| | Choose File No file chosen | |
| Local Certificate | <input type="text"/> | |
| | Choose File No file chosen | |
| Local Private Key | <input type="text"/> | |
| | Choose File No file chosen | |
| Identity | <input type="text"/> | |
| Local Private Key Password | <input type="text"/> | |
| * can be blank | | |
| Apply | | |

Figure 15: LAN Configuration for Example 2

Example 3: IPv6 Dynamic DHCP Server

- The range of dynamic allocated IPv6 addresses is from 2001:db8::1 to 2001:db8::ffff.
- The address is allocated for 600 second (10 minutes).
- The router is still accessible via IPv4 (192.168.1.1).

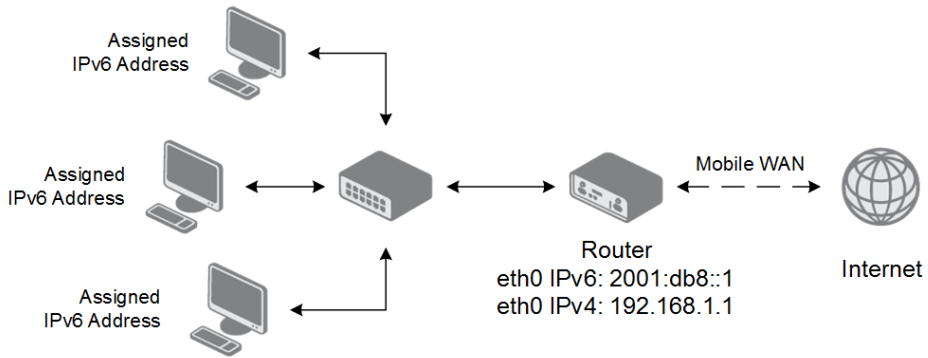

Figure 16: Network Topology for Example 3

| ETH0 Configuration | | |
|--|---|---------------------|
| DHCP Client | IPv4 disabled | IPv6 disabled |
| IP Address | 192.168.1.1 | 2001:db8::1 |
| Subnet Mask / Prefix | 255.255.255.0 | 64 |
| Default Gateway | | |
| DNS Server | | |
| Bridged | no | |
| Media Type | auto-negotiation | |
| <input checked="" type="checkbox"/> Enable dynamic DHCP leases | | |
| IP Pool Start | IPv4 | IPv6 2001:db8::2 |
| IP Pool End | | 2001:db8::fff |
| Lease Time | | 600 sec |
| <input type="checkbox"/> Enable static DHCP leases | | |
| MAC Address | IP Address | IPv6 Address |
| | | |
| | | |
| | | |
| | | |
| | | |
| | | |
| <input type="checkbox"/> Enable IPv6 prefix delegation | | |
| Subnet ID * | | |
| Subnet ID Width * | | bits |
| <input type="checkbox"/> Enable IEEE 802.1X Authentication | | |
| Authentication Method | EAP-TLS | |
| CA Certificate | <input type="text"/> <input type="button" value="Choose File"/> No file chosen | |
| Local Certificate | <input type="text"/> <input type="button" value="Choose File"/> No file chosen | |
| Local Private Key | <input type="text"/> <input type="button" value="Choose File"/> No file chosen | |
| Identity | <input type="text"/> | |
| Local Private Key Password | <input type="text"/> | |
| * can be blank | | |
| <input type="button" value="Apply"/> | | |

Figure 17: LAN Configuration for Example 3

4.2 VRRP Configuration

Select the *VRRP* menu item to enter the VRRP configuration. There are two submenus which allows to configure up to two instances of VRRP. VRRP protocol (Virtual Router Redundancy Protocol) allows you to transfer packet routing from the main router to a backup router in case the main router fails. (This can be used to provide a wireless cellular backup to a primary wired router in critical applications.) If the *Enable VRRP* is checked, you may set the following parameters.

| Item | Description |
|---------------------------|---|
| Protocol Version | Choose version of the VRRP (VRRPv2 or VRRPv3). |
| Virtual Server IP Address | This parameter sets the virtual server IP address. This address must be the same for both the primary and backup routers. Devices on the LAN will use this address as their default gateway IP address. |
| Virtual Server ID | This parameter distinguishes one virtual router on the network from another. The main and backup routers must use the same value for this parameter. |
| Host Priority | The active router with highest priority set by the parameter Host Priority, is the main router. According to RFC 2338, the main router should have the highest possible priority – 255. The backup router(s) have a priority in the range 1 – 254 (default value is 100). A priority value of 0 is not allowed. |

Table 17: VRRP configuration

You may set the *Check connection* flag in the second part of the window to enable automatic test messages for the cellular network. In some cases, the mobile WAN connection could still be active but the router will not be able to send data over the cellular network. This feature is used to verify that data can be sent over the PPP connection and supplements the normal VRRP message handling. The currently active router (main/backup) will send test messages to the defined *Ping IP Address* at periodic time intervals (*Ping Interval*) and wait for a reply (*Ping Timeout*). If the router does not receive a response to the Ping command, it will retry up to the number of times specified by the *Ping Probes* parameter. After that time, it will switch itself to a backup router until the PPP connection is restored.



You may use the DNS server of the mobile carrier as the destination IP address for the test messages (Pings).

The *Enable traffic monitoring* option can be used to reduce the number of messages that are sent to test the PPP connection. When this parameter is set, the router will monitor the interface for any packets different from a ping. If a response to the packet is received within the timeout specified by the *Ping Timeout* parameter, then the router knows that the connection is still active. If the router does not receive a response within the timeout period, it will attempt to test the mobile WAN connection using standard Ping commands.

| Item | Description |
|-----------------|--|
| Ping IP Address | Destinations IP address for the Ping commands. IP Address can not be specified as a domain name. |
| Ping Interval | Interval in seconds between the outgoing Pings. |
| Ping Timeout | Time in seconds to wait for a response to the Ping. |
| Ping Probes | Maximum number of failed ping requests. |

Table 18: Check connection

Example of the VRRP protocol:

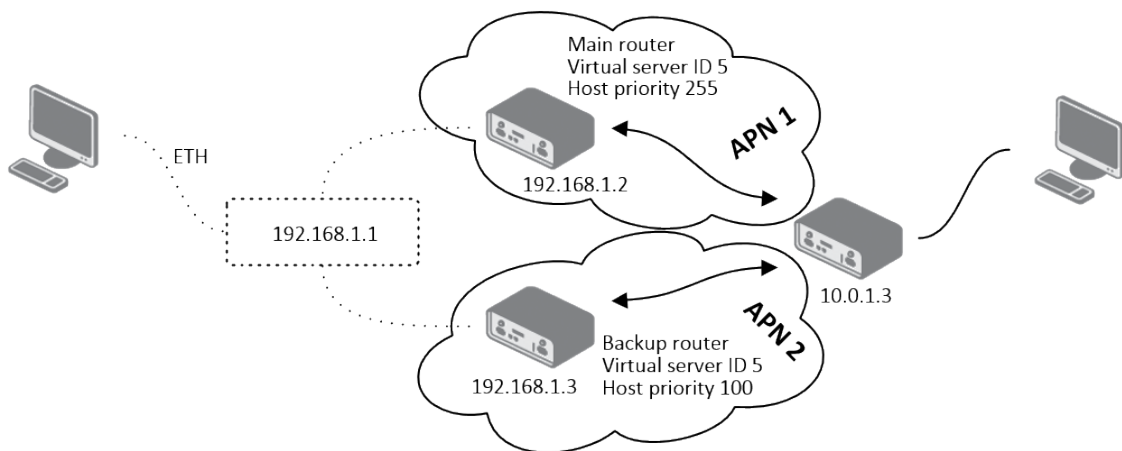

Figure 18: Topology of VRRP configuration example

1st VRRP Instance Configuration

Enable 1st VRRP Instance

Protocol Version: VRRPv2

Virtual Server IP Address: 192.168.1.1

Virtual Server ID: 5

Host Priority: 255

Check connection

Ping IP Address: 10.0.1.3

Ping Interval: 10 sec

Ping Timeout: 5 sec

Ping Probes: 10

Enable traffic monitoring

Apply

Figure 19: Example of VRRP configuration – main router

| 1st VRRP Instance Configuration | |
|--|-------------|
| <input checked="" type="checkbox"/> Enable 1st VRRP Instance | |
| Protocol Version | VRRPv2 |
| Virtual Server IP Address | 192.168.1.1 |
| Virtual Server ID | 5 |
| Host Priority | 100 |
| <input checked="" type="checkbox"/> Check connection | |
| Ping IP Address | 10.0.1.3 |
| Ping Interval | 10 sec |
| Ping Timeout | 5 sec |
| Ping Probes | 10 |
| <input type="checkbox"/> Enable traffic monitoring | |
| <input type="button" value="Apply"/> | |

Figure 20: Example of VRRP configuration – backup router

4.3 Mobile WAN Configuration



Notes for models with one SIM slot:

- You can still configure the 2nd SIM card in the GUI described in this chapter.
- You can switch to the 2nd SIM card which means that the configuration for the 2nd SIM will be applied to the installed SIM.
- You can utilize this setting to e.g. configure public and private APN independently.
- The configuration can be switched manually, by SMS, or automatically if configured.

Select the *Mobile WAN* item in the *Configuration* menu section to enter the cellular network configuration page. See *Mobile WAN Configuration* page in Figure 21.

4.3.1 Connection to Mobile Network

If the *Create connection to mobile network* checkbox is checked, then the router will automatically attempt to establish a connection after booting up. You can specify the following parameters for each SIM card separately.

| Item | Description |
|----------------|---|
| Carrier | Available For NAM routers only. Network carrier selection. Provides either <i>automatic detection</i> option, or manual selection of <i>AT&T</i> , <i>Rogers</i> or <i>Verizon</i> . |
| APN | Network identifier (Access Point Name). |
| Username | The user name used for logging on to the GSM network. |
| Password | The password used for logging on to the GSM network. Enter valid characters only, see chap. 2.3! |
| Authentication | Authentication protocol used in the GSM network: <ul style="list-style-type: none"> • PAP or CHAP – The router selects the authentication method. • PAP – The router uses the PAP authentication method. • CHAP – The router uses the CHAP authentication method. |
| IP Mode | Specifies the version of IP protocol used: <ul style="list-style-type: none"> • IPv4 – IPv4 protocol is used only (default). • IPv6 – IPv6 protocol is used only. • IPv4/IPv6 – IPv4 and IPv6 independent dual stack is enabled. |

Continued on next page

Continued from previous page

| Item | Description |
|--------------|---|
| IP Address | For use in IPv4 and IPv4/IPv6 mode only. Specifies the IPv4 address of the SIM card. You manually enter the IP address only when mobile network carrier has assigned the IP address. |
| Dial Number | Specifies the telephone number which the router dials for GPRS or a CSD connection. The router uses the default telephone number *99***1 #. |
| Operator | Specifies the carrier code. You can specify this parameter as the PLMN preferred carrier code. |
| Network type | Specifies the type of protocol used in the mobile network. Automatic selection - The router automatically selects the transmission method according to the availability of transmission technologies. Automatic selection never selects NB-IoT networks. Use NB-IoT in the selection for NB-IoT networks. |
| PIN | Specifies the PIN used to unlock the SIM card. Use only if this is required by a given SIM card. The SIM card will be blocked after several failed attempts to enter the PIN. |
| MRU | Maximum Receive Unit – maximum size of packet that the router can receive via Mobile WAN. The default value is 1500 B. Other settings may cause the router to receive data incorrectly. Minimal value in IPv4 and IPv4/IPv6 mode: 128 B. Minimal value in IPv6 mode: 1280 B. |
| MTU | Maximum Transmission Unit – maximum size of packet that the router can transmit via Mobile WAN. The default value is 1500 B. Other settings may cause the router to transmit data incorrectly. Minimal value in IPv4 and IPv4/IPv6 mode: 128 B. Minimal value in IPv6 mode: 1280 B. |

Table 19: Mobile WAN Connection Configuration



The following list contains tips for working with the *Mobile WAN* configuration form:

- If the MTU size is set incorrectly, then the router will not exceed the data transfer. If the MTU value is set too low, more frequent fragmentation of data will occur. More frequent fragmentation will mean a higher overhead and also the possibility of packet damage during defragmentation. In contrast, a higher MTU value can cause the network to drop the packet.
- If the *IP address* field is left blank, when the router establishes a connection, the mobile network carrier will automatically assign an IP address. If you assign an IP address manually, then the router will access the network quicker.
- If the **APN** field is left blank, the router automatically selects the APN using the IMSI code of the SIM card. The name of the chosen APN can be found in the System Log.

- If you enter the word `blank` in the *APN* field, then the router interprets the APN as blank.



The correct PIN must be filled in. An incorrect PIN may block the SIM card.

Parameters identified with an asterisk require you to enter the appropriate information only if this information is required by the mobile network carrier.

| 1st Mobile WAN Configuration | | | |
|---|-----------------------|-----------------------|-------|
| <input checked="" type="checkbox"/> Create connection to mobile network | | | |
| | 1st SIM card | 2nd SIM card | |
| APN * | advantech.agnep.cz | | |
| Username * | | | |
| Password * | | | |
| Authentication | PAP or CHAP ▼ | PAP or CHAP ▼ | |
| IP Mode | IPv4 ▼ | IPv4 ▼ | |
| IP Address * | | | |
| Dial Number * | | | |
| Operator * | | | |
| Network Type | automatic selection ▼ | automatic selection ▼ | |
| PIN * | | | |
| MRU | 1500 | 1500 | bytes |
| MTU | 1500 | 1500 | bytes |
| DNS Settings | get from operator ▼ | get from operator ▼ | |
| DNS IP Address | | | |
| DNS IPv6 Address | | | |
| <i>(The feature of check connection to mobile network is necessary for uninterrupted operation)</i> | | | |
| Check Connection | disabled ▼ | disabled ▼ | |
| Ping IP Address | | | |
| Ping IPv6 Address | | | |
| Ping Interval | | | sec |
| Ping Timeout | 10 | 10 | sec |
| <input type="checkbox"/> Enable traffic monitoring | | | |
| Data Limit | | | MB |
| Warning Threshold | | | % |
| Accounting Start | 1 | 1 | |
| SIM Card | enabled ▼ | disabled ▼ | |
| Roaming State | not applicable ▼ | not applicable ▼ | |
| Data Limit State | not applicable ▼ | not applicable ▼ | |
| BIN0 State | not applicable ▼ | not applicable ▼ | |
| Default SIM Card | 1st ▼ | | |
| Initial State | online ▼ | | |
| <input type="checkbox"/> Switch to other SIM card when connection fails | | | |
| <input type="checkbox"/> Switch to default SIM card after timeout | | | |
| Initial Timeout | 60 | | min |
| Subsequent Timeout * | | | min |
| Additive Constant * | | | min |
| <input type="checkbox"/> Enable PPPoE bridge mode | | | |

Figure 21: Mobile WAN Configuration

When the router is unsuccessful in establishing a connection to mobile network, you should verify accuracy of the entered data. Alternatively, you could try a different authentication method or network type.

4.3.2 DNS Address Configuration

The *DNS Settings* parameter is designed for easier configuration on the client's side. When this value is set to *get from operator* the router will attempt to automatically obtain an IP address from the primary and secondary DNS server of the mobile network carrier. To specify the IP addresses of the Primary DNS servers manually, on the *DNS Server* pull down list select the value *set manually*. You can also fill-in the IPv4 or IPv6 address of the DNS server (or both) based on the IP Mode option.

4.3.3 Check Connection to Mobile Network



Enabling the *Check Connection* function for mobile networks is necessary for uninterrupted and continuous operation of the router.

If the *Check Connection* item is set to *enabled* or *enabled + bind*, the router will be sending the ping requests to the specified domain or IP address configured in *Ping IP Address* or *Ping IPv6 Address* at regular time intervals set up in the *Ping Interval*.

In case of an unsuccessful ping, a new ping will be sent after the *Ping Timeout*. If the ping is unsuccessful three times in a row, the router will terminate the cellular connection and will attempt to establish a new one.

This monitoring function can be set for both SIM cards separately, but running on the active SIM at given time only. Be sure, you configure a functional address as the destination for the ping, for example an IP address of the operator's DNS server.

If the *Check Connection* item is set to the *enabled*, the ping requests are being sent on the basis of the routing table. Therefore, the requests may be sent through any available interface. If you require each ping request to be sent through the network interface, which was created when establishing a connection to the mobile operator, it is necessary to set the *Check Connection* to *enabled + bind*. The *disabled* option deactivates checking of the connection to the mobile network.



A note for routers connected to the **Verizon** carrier (detected by the router):
The retry interval for connecting to the mobile network prolongs with more retries. First two retries are done after 1 minute. Then the interval prolongs to 2, 8 and 15 minutes. The ninth and every other retry is done in 90 minutes interval.

If *Enable Traffic Monitoring* item is checked, the router will monitor the Mobile WAN traffic without sending the ping requests. If there is no traffic, the router will start sending the ping requests.

| Item | Description |
|-------------------|--|
| Ping IP Address | Specifies the ping queries destination IPv4 address or domain name. Available in IPv4 and IPv4/IPv6 <i>IP Mode</i> . |
| Ping IPv6 Address | Specifies the ping queries destination IPv6 address or domain name. Available in IPv6 and IPv4/IPv6 <i>IP Mode</i> . |
| Ping Interval | Specifies the time interval between outgoing pings. |
| Ping Timeout | Time in seconds to wait for a Ping response. |

Table 20: Check Connection to Mobile Network Configuration

4.3.4 Check Connection Example

The figure below displays the following scenario: the connection to the mobile network in IPv4 *IP Mode* is controlled on the address 8.8.8.8 with a time interval of 60 seconds for the first SIM card and on the address www.google.com with the time interval 80 seconds for the second SIM card (for an active SIM only). Because the *Enable traffic monitoring* option is enabled, the control pings are not sent, but the data stream is monitored. The ping will be sent, if the data stream is interrupted.

(The feature of check connection to mobile network is necessary for uninterrupted operation)

| | | |
|-------------------|-----------|----------------|
| Check Connection | enabled ▼ | enabled ▼ |
| Ping IP Address | 8.8.8.8 | www.google.com |
| Ping IPv6 Address | | |
| Ping Interval | 60 | 80 sec |
| Ping Timeout | 60 | 80 sec |

Enable traffic monitoring

Figure 22: Check Connection Example

4.3.5 Data Limit Configuration



If the parameter *Data Limit State* (see below) is set to *not applicable* or *Send SMS when data limit is exceeded* in *SMS Configuration* is not selected, the *Data Limit* set here will be ignored.

4.3.6 Switch between SIM Cards Configuration

In the lower part of the configuration form you can specify the rules for toggling between the two SIM cards.



The router will automatically toggle between the SIM cards and their individual setups depending on the configuration settings specified here (manual permission, roaming, data limit, binary input state). Note that the SIM card selected for connection establishment is the result of the logical product (AND) of the configuration here (table below).

| Item | Description |
|-------------------|--|
| Data Limit | Specifies the maximum expected amount of data transmitted (sent and received) over mobile interface in one billing period (one month). Maximum value is 2 TB (2097152 MB). |
| Warning Threshold | Specifies a percentage of the "Data Limit" in the range of 50 % to 99 %. If the given percentage data limit is exceeded, the router will send an SMS in the following form; <i>Router has exceeded (value of Warning Threshold) of data limit.</i> |
| Accounting Start | Specifies the day of the month in which the billing cycle starts for a given SIM card. When the service provider that issued the SIM card specifies the start of the billing period, the router will begin to count the amount of data transferred starting on this day. |

Table 21: Data Limit Configuration

| Item | Description |
|------------------|--|
| SIM Card | <p>Enable or disable the use of a SIM card. If you set all the SIM cards to <i>disabled</i>, this means that the entire cellular module is disabled.</p> <ul style="list-style-type: none"> • enabled – It is possible to use the SIM card. • disabled – Never use the SIM card, the usage of this SIM is forbidden. |
| Roaming State | <p>Configure the use of SIM cards based on roaming. This roaming feature has to be activated for the SIM card on which it is enabled!</p> <ul style="list-style-type: none"> • not applicable – It is possible to use the SIM card everywhere. • home network only – Only use the SIM card if roaming is not detected. |
| Data Limit State | <p>Configure the use of SIM cards based on the Data Limit set above:</p> <ul style="list-style-type: none"> • not applicable – It is possible to use the SIM regardless of the limit. • not exceeded – Use the SIM card only if the Data Limit (set above) has not been exceeded. |

Continued on next page

Continued from previous page

| Item | Description |
|------------|---|
| BINx State | <p>Configure the use of SIM cards based on binary input <i>x</i> state, where <i>x</i> is the input number:</p> <ul style="list-style-type: none"> • not applicable – It is possible to use the SIM regardless of BINx state. • on – Only use the SIM card if the BINx state is logical 0 – voltage present. • off – Only use the SIM card if the BINx state is logical 1 – no voltage. |

Table 22: Switch between SIM cards configuration

Use the following parameters to specify the decision making of SIM card switching in the cellular module.

| Item | Description |
|--|---|
| Default SIM Card | <p>Specifies the modules' default SIM card. The router will attempt to establish a connection to mobile network using this default.</p> <ul style="list-style-type: none"> • 1st – The 1st SIM card is the default one. • 2nd – The 2nd SIM card is the default one. |
| Initial State | <p>Specifies the action of the cellular module after the SIM card has been selected.</p> <ul style="list-style-type: none"> • online – establish connection to the mobile network after the SIM card has been selected (default). • offline – go to the off-line mode after the SIM card has been selected. <p>Note: If offline, you can change this initial state by SMS message only – see <i>SMS Configuration</i>. The cellular module will also go into off-line mode if none of the SIM cards are not selected.</p> |
| Switch to other SIM card when connection fails | <p>Applicable only when connection is established on the default SIM card and then fails. If the connection failure is detected by <i>Check Connection</i> feature above, the router will switch to the backup SIM card.</p> |

Continued on next page

Continued from previous page

| Item | Description |
|--|---|
| Switch to default SIM card after timeout | If enabled, after timeout, the router will attempt to switch back to the default SIM card. This applies only when there is default SIM card defined and the backup SIM is selected because of a failure of the default one or if roaming settings cause the switch. This feature is available only when <i>Switch to other SIM card when connection fails</i> is enabled. |
| Initial Timeout | Specifies the length of time that the router waits before the first attempt to revert to the default SIM card, the range of this parameter is from 1 to 10000 minutes. |
| Subsequent Timeout | Specifies the length of time that the router waits after an unsuccessful attempt to revert to the default SIM card, the range is from 1 to 10000 min. |
| Additive Constant | Specifies the length of time that the router waits for any further attempts to revert to the default SIM card. This length time is the sum of the time specified in the "Subsequent Timeout" parameter and the time specified in this parameter. The range in this parameter is from 1 to 10000 minutes. |

Table 23: Parameters for SIM card switching

4.3.7 Examples of SIM Card Switching Configuration

Example 1: Timeout Configuration

Mark the *Switch to default SIM card after timeout* check box, and fill-in the following values:

Switch to other SIM card when connection fails

Switch to default SIM card after timeout

Initial Timeout min

Subsequent Timeout * min

Additive Constant * min

Figure 23: Configuration for SIM card switching Example 1

The first attempt to change to the default SIM card is carried out after 60 minutes. When the first attempt fails, a second attempt is made after 30 minutes. A third attempt is made after 50 minutes (30+20). A fourth attempt is made after 70 minutes (30+20+20).

Example 2: Data Limit Switching

The following configuration illustrates a scenario in which the router changes to the second SIM card after exceeding the data limit of 800 MB on the first (default) SIM card. The router sends a SMS upon reaching 400 MB (this settings has to be enabled on the *SMS Configuration* page). The accounting period starts on the 18th day of the month.

| | | | |
|--|---|---|-----|
| Data Limit | <input type="text" value="800"/> | <input type="text"/> | MB |
| Warning Threshold | <input type="text" value="50"/> | <input type="text"/> | % |
| Accounting Start | <input type="text" value="18"/> | <input type="text" value="1"/> | |
| SIM Card | <input type="text" value="enabled"/> | <input type="text" value="enabled"/> | |
| Roaming State | <input type="text" value="not applicable"/> | <input type="text" value="not applicable"/> | |
| Data Limit State | <input type="text" value="not applicable"/> | <input type="text" value="not applicable"/> | |
| BIN0 State | <input type="text" value="not applicable"/> | <input type="text" value="not applicable"/> | |
| Default SIM Card | <input type="text" value="1st"/> | | |
| Initial State | <input type="text" value="online"/> | | |
| <input type="checkbox"/> Switch to other SIM card when connection fails <input type="checkbox"/> Switch to default SIM card after timeout | | | |
| Initial Timeout | <input type="text"/> | | min |
| Subsequent Timeout * | <input type="text"/> | | min |
| Additive Constant * | <input type="text"/> | | min |

Figure 24: Configuration for SIM card switching Example 2

4.3.8 PPPoE Bridge Mode Configuration

If you mark the *Enable PPPoE bridge mode* check box, the router activates the PPPoE bridge protocol. PPPoE (point-to-point over ethernet) is a network protocol for encapsulating Point-to-Point Protocol (PPP) frames inside Ethernet frames. The bridge mode allows you to create a PPPoE connection from a device behind the router. For example, a PC connected to the ETH port of the router. You assign the IP address of the SIM card to the PC. The changes in settings will apply after clicking the *Apply* button.

4.4 PPPoE Configuration

PPPoE (Point-to-Point over Ethernet) is a network protocol which encapsulates PPP frames into Ethernet frames. The router uses the PPPoE client to connect to devices supporting a PPPoE bridge or server. The bridge or server is typically an ADSL router.

To open the *PPPoE Configuration* page, select the *PPPoE* menu item. If you mark the *Create PPPoE connection* check box, then the router attempts to establish a PPPoE connection after boot up. After connecting, the router obtains the IP address of the device to which it is connected. The communications from a device behind the PPPoE server is forwarded to the router.

PPPoE Configuration

Create PPPoE connection
 Username *
 Password *
 Authentication ▼ PAP or CHAP
 IP Mode ▼ IPv4
 MRU bytes
 MTU bytes

 DNS Settings ▼ get from server
 DNS IP Address
 DNS IPv6 Address

 Interface ▼ secondary
 VLAN Tagging ▼ no
 VLAN ID

Figure 25: PPPoE Configuration

| Item | Description |
|----------|--|
| Username | Username for secure access to PPPoE. |
| Password | Password for secure access to PPPoE. Enter valid characters only, see chap. 2.3! |

Continued on next page

Continued from previous page

| Item | Description |
|----------------|--|
| Authentication | <p>Authentication protocol in GSM network.</p> <ul style="list-style-type: none"> • PAP or CHAP – The router selects the authentication method. • PAP – The router uses the PAP authentication method. • CHAP – The router uses the CHAP authentication method. |
| IP Mode | <p>Specifies the version of IP protocol:</p> <ul style="list-style-type: none"> • IPv4 – IPv4 protocol is used only (default). • IPv6 – IPv6 protocol is used only. • IPv4/IPv6 – IPv4 and IPv6 dual stack is enabled. |
| MRU | <p>Specifies the Maximum Receiving Unit. The MRU identifies the maximum packet size, that the router can receive via PPPoE. The default value is 1492 B (bytes). Other settings can cause incorrect data transmission. Minimal value in IPv4 and IPv4/IPv6 mode is 128 B. Minimal value in IPv6 mode is 1280 B.</p> |
| MTU | <p>Specifies the Maximum Transmission Unit. The MTU identifies the maximum packet size, that the router can transfer in a given environment. The default value is 1492 B (bytes). Other settings can cause incorrect data transmission. Minimal value in IPv4 and IPv4/IPv6 mode is 128 B. Minimal value in IPv6 mode is 1280 B.</p> |
| DNS Settings | <p>Can be set to obtain the DNS address from the server or to set it manually.</p> |
| DNS IP Address | <p>Manual setting of DNS address.</p> |
| DNS IP Address | <p>Manual setting of IPv6 DNS address.</p> |
| Interface | <p>Select an Ethernet interface.</p> |
| VLAN Tagging | <p>Select yes to turn on the VLAN tagging.</p> |
| VLAN ID | <p>Set the ID for VLAN tagging. The range is from 1 to 1000.</p> |

Table 24: PPPoE configuration



Setting an incorrect packet size value (MRU, MTU) can cause unsuccessful transmission.

4.5 Backup Routes

Using the configuration form on the *Backup Routes* page (see Figure 26), you can back up the primary connection with alternative connections to the Internet (mobile network) or enable *Multiple WANs* mode. It is also possible to prioritize each backup connection option. Switching between connections is carried out according to the order of priority and the state of the connections.

| Item | Description |
|--------------------------------|--|
| Enable backup routes switching | The default route is selected according to the settings below. If disabled (unchecked), the backup routes system operates in the backward compatibility mode based on the default priorities of the network interfaces (listed below). |
| Mode | <ul style="list-style-type: none"> • Single WAN – The default mode. Only one interface is used for WAN communication at a time. Other interfaces are used for WAN when the preferred interface fails, based on the priorities set. • Multiple WANs – Multiple interfaces can be used for WAN connection. When WAN communication via multiple interfaces is received, the same interface is used in reply, therefore; the traffic will stay on the given interface. The set priorities are used when transmitting data from the router or from the network behind the router. The highest priority interface is used for these transmissions. • Load Balancing – In this mode, the weight for every interface can be set. This setting determines the relative number of data streams going through the interfaces. Please note that this may not exactly match the amount of data, it very depends on the number of streams and the structure of the data. |

Table 25: Backup Route Modes



Please note that the weight setting for load balancing may not exactly match the amount of balanced data. It depends on the number of data flows and the structure of the data. The best result of the balancing is achieved for a high amount of data flows.

To add the network interfaces to the backup routes system, mark the checkbox(s) for some of the following interface options: *Enable backup routes switching for Mobile WAN*, *Enable backup routes switching for PPPoE*, *Enable backup routes switching for ETH0*, *Enable backup routes switching for ETH1*. Enabled interfaces are then used for WAN access either in *Single WAN* mode (only one interface at a time) or in *Multiple WANs* mode (multiple interfaces at a time), based on the priorities set.



If you want to use a mobile WAN connection as a backup route, you must choose the *enable + bind* option in the *Check Connection* item on the *Mobile WAN* page and fill in the ping address. See chapter 4.3.1.

Settings, which can be made for an interface, is described in the table below.

| Item | Description |
|-------------------|--|
| Priority | Priority for the type of connection (network interface). |
| Ping IP Address | Destination IPv4 address or domain name of ping queries to check the connection. |
| Ping IPv6 Address | Destination IPv6 address or domain name of ping queries to check the connection. |
| Ping Interval | The time interval between consecutive ping queries. |
| Ping Timeout | Time in seconds to wait for a response to the Ping. |
| Weight | Weight for the Load Balancing mode only. The number from 1 to 256 determines the ratio for load balancing of the interface. For example, if two interfaces have set up the weight to 1, the ratio is 50% to 50%. If they have set up the weight to 1 and 4, the ratio is 20% to 80%. |

Table 26: Backup Routes

Network interfaces belonging to individual backup routes are also checked before use for flags which indicate the state of the interface. (E.g. RUNNING on the *Network Status* page.) This prevents, for example, the disconnection of an Ethernet cable. You can fill-in one or both Ping IP Addresses (IPv4 and IPv6) – based on IP protocol used on particular network interface and WAN connection settings. IPv4 and IPv6 are dual stack implemented in the router. Any changes made to settings will be applied after pressing the *Apply* button.

4.5.1 Default Priorities for Backup Routes

If the *Enable backup routes switching* check box is unchecked, the backup routes system will operate in the backward compatibility mode. The router selects the route based on the default priorities of the enabled settings for each of the network interfaces, enabling appropriate services that comply with these network interfaces. The following list contains the names of backup routes and corresponding network interfaces in order of default priorities:

- Mobile WAN (pppX, usbX)
- PPPoE (ppp0)
- ETH1 (eth1)
- ETH0 (eth0)

Example of default priorities: *Backup Routes* function is disabled. The router selects the *ETH1* as the default route only if you unmark the *Create connection to mobile network* check box on the *Mobile WAN* page, unmark the *Create PPPoE connection* check box on the *PPPoE*. To select the *ETH0*, delete the IP address from the *ETH1* page and disable the *DHCP Client* for the *ETH1*.



Note: Consider there is a concept of variable WAN and LAN interfaces even if the *Backup Routes* are not enabled. The situation may occur, that LAN intended interface becomes WAN interface (because of specified or default priorities). Communication from WAN interface to LAN interface can then be blocked depending on the *NAT* and *Firewall* Configuration.

| Backup Routes Configuration | |
|--|------------|
| <input type="checkbox"/> Enable backup routes switching | |
| Mode | Single WAN |
| <input type="checkbox"/> Enable backup routes switching for Mobile WAN | |
| Priority | 1st |
| Weight | |
| <input type="checkbox"/> Enable backup routes switching for PPPoE | |
| Priority | 1st |
| Ping IP Address | |
| Ping IPv6 Address | |
| Ping Interval | sec |
| Ping Timeout | 10 sec |
| Weight | |
| <input type="checkbox"/> Enable backup routes switching for ETH0 | |
| Priority | 1st |
| Ping IP Address | |
| Ping IPv6 Address | |
| Ping Interval | sec |
| Ping Timeout | 10 sec |
| Weight | |
| <input type="checkbox"/> Enable backup routes switching for ETH1 | |
| Priority | 1st |
| Ping IP Address | |
| Ping IPv6 Address | |
| Ping Interval | sec |
| Ping Timeout | 10 sec |
| Weight | |
| <input type="button" value="Apply"/> | |

Figure 26: Backup Routes Configuration

4.6 Static Routes

Static routes can be specified on the *Static Routes* configuration page. A static route provide fixed routing path through the network. It is manually configured on the router and must be updated if the network topology was changed recently. Static routes are private routers unless they are redistributed by a routing protocol. There are two forms, one for IPv4 and the second for IPv6 configuration. Static routes configuration form for IPv4 is shown on Figure 27.

IPv4 Static Routes Configuration

Enable IPv4 static routes

| | Destination Network | Mask or Prefix Length | Gateway * | Metric * | Interface |
|--------------------------|----------------------|-----------------------|----------------------|----------------------|-----------|
| <input type="checkbox"/> | <input type="text"/> | <input type="text"/> | <input type="text"/> | <input type="text"/> | ETH0 ▾ |
| <input type="checkbox"/> | <input type="text"/> | <input type="text"/> | <input type="text"/> | <input type="text"/> | ETH0 ▾ |
| <input type="checkbox"/> | <input type="text"/> | <input type="text"/> | <input type="text"/> | <input type="text"/> | ETH0 ▾ |
| <input type="checkbox"/> | <input type="text"/> | <input type="text"/> | <input type="text"/> | <input type="text"/> | ETH0 ▾ |
| <input type="checkbox"/> | <input type="text"/> | <input type="text"/> | <input type="text"/> | <input type="text"/> | ETH0 ▾ |
| <input type="checkbox"/> | <input type="text"/> | <input type="text"/> | <input type="text"/> | <input type="text"/> | ETH0 ▾ |
| <input type="checkbox"/> | <input type="text"/> | <input type="text"/> | <input type="text"/> | <input type="text"/> | ETH0 ▾ |
| <input type="checkbox"/> | <input type="text"/> | <input type="text"/> | <input type="text"/> | <input type="text"/> | ETH0 ▾ |

* can be blank

Figure 27: Static Routes Configuration

The description of all items is listed in Table 27.

| Item | Description |
|---------------------------|--|
| Enable IPv4 static routes | If checked, static routing functionality is enabled. Active are only routes enabled by the checkbox in the first column of the table. |
| Destination Network | The destination IP address of the remote network or host to which you want to assign a static route. |
| Mask or Prefix Length | The subnet mask of the remote network or host IP address. |
| Gateway | IP address of the gateway device that allows for contact between the router and the remote network or host. |
| Metric | Metric definition, means number rating of the priority for the route in the routing table. Routes with lower metrics have higher priority. |
| Interface | Select an interface the remote network or host is on. |

Table 27: Static Routes Configuration for IPv4

4.7 Firewall Configuration

The first security element for incoming packets is a check of the enabled source IP addresses and destination ports. There is independent IPv4 and IPv6 firewall since there is dual stack IPv4 and IPv6 implemented in the router. If you click the *Firewall* item in the *Configuration* menu on the left, it will expand to *IPv4* and *IPv6* options and you can click *IPv6* to enable and configure the IPv6 firewall – see Figure below. The configuration fields have the same meaning in the *IPv4 Firewall Configuration* and *IPv6 Firewall Configuration* forms.

IPv6 Firewall Configuration

Enable filtering of incoming packets

| Source * | Protocol | Target Port(s) * | Action | Description * |
|----------------------|----------|----------------------|--------|----------------------|
| <input type="text"/> | all | <input type="text"/> | allow | <input type="text"/> |
| <input type="text"/> | all | <input type="text"/> | allow | <input type="text"/> |
| <input type="text"/> | all | <input type="text"/> | allow | <input type="text"/> |
| <input type="text"/> | all | <input type="text"/> | allow | <input type="text"/> |
| <input type="text"/> | all | <input type="text"/> | allow | <input type="text"/> |
| <input type="text"/> | all | <input type="text"/> | allow | <input type="text"/> |
| <input type="text"/> | all | <input type="text"/> | allow | <input type="text"/> |

Enable filtering of forwarded packets

| Source * | Destination * | Protocol | Target Port(s) * | Action | Description * |
|----------------------|----------------------|----------|----------------------|--------|----------------------|
| <input type="text"/> | <input type="text"/> | all | <input type="text"/> | allow | <input type="text"/> |
| <input type="text"/> | <input type="text"/> | all | <input type="text"/> | allow | <input type="text"/> |
| <input type="text"/> | <input type="text"/> | all | <input type="text"/> | allow | <input type="text"/> |

Enable filtering of locally destined packets

| | | | | | |
|----------------------|----------------------|-----|----------------------|-------|----------------------|
| <input type="text"/> | <input type="text"/> | all | <input type="text"/> | allow | <input type="text"/> |
| <input type="text"/> | <input type="text"/> | all | <input type="text"/> | allow | <input type="text"/> |
| <input type="text"/> | <input type="text"/> | all | <input type="text"/> | allow | <input type="text"/> |
| <input type="text"/> | <input type="text"/> | all | <input type="text"/> | allow | <input type="text"/> |

Enable protection against DoS attacks
* can be blank

Figure 28: Firewall Configuration – IPv6 Firewall

You can specify the rules for IP addresses, protocols and ports to allow or deny the access to the router and internal network connected behind the router. To enable this function, tick the *Enable filtering of incoming packets* check box located at the top of the *IPv4 (IPv6) Firewall Configuration* page. Accessibility is checked against the IP address table. This means that access is permitted only to addresses allowed in the table. It is possible to specify up to

sixteen rules. You can specify the following parameters:

| Item | Description |
|----------------|--|
| Source | IP address the rule applies to. Use IPv4 address in <i>IPv4 Firewall Configuration</i> and IPv6 address in <i>IPv6 Firewall Configuration</i> . |
| Protocol | Specifies the protocol the rule applies to: <ul style="list-style-type: none"> • all – The rule applies to all protocols. • TCP – The rule applies to TCP protocol. • UDP – The rule applies to UDP protocol. • GRE – The rule applies to GRE protocol. • ESP – The rule applies to ESP protocol. • ICMP/ICMPv6 – The rule applies to ICMP protocol. In <i>IPv6 Firewall Configuration</i> there is the ICMPv6 option. |
| Target Port(s) | The port numbers range allowing access to the router. Enter the initial and final port numbers separated by the hyphen mark. One static port is allowed as well. |
| Action | Specifies the rule – the type of action the router performs: <ul style="list-style-type: none"> • allow – The router allows the packets to enter the network. • deny – The router denies the packets from entering the network. |
| Description | Description of the rule. |

Table 28: Filtering of Incoming Packets

The next section of the configuration form specifies the forwarding policy. If you unmark the *Enabled filtering of forwarded packets* check box, then packets are automatically accepted. If you activate this function, and a packet is addressed to another network interface, then the router sends the packet to the FORWARD chain. When the FORWARD chain accepts the packet and there is a rule for forwarding it, the router sends the packet. If a forwarding rule is unavailable, then the router drops the packet. It is possible to specify up to sixteen rules.

This configuration form also contains a table for specifying the filter rules. It is possible to create a rule to allow data with the selected protocol by specifying only the protocol, or to create stricter rules by specifying values for source IP addresses, destination IP addresses, and ports.

| Item | Description |
|----------------|--|
| Source | IP address the rule applies to. Use IPv4 address in <i>IPv4 Firewall Configuration</i> and IPv6 address in <i>IPv6 Firewall Configuration</i> . |
| Destination | Destination IP address the rule applies to. Use IPv4 address in <i>IPv4 Firewall Configuration</i> and IPv6 address in <i>IPv6 Firewall Configuration</i> . |
| Protocol | Specifies the protocol the rule applies to: <ul style="list-style-type: none"> • all – The rule applies to all protocols. • TCP – The rule applies to TCP protocol. • UDP – The rule applies to UDP protocol. • GRE – The rule applies to GRE protocol. • ESP – The rule applies to ESP protocol. • ICMP/ICMPv6 – The rule applies to ICMP protocol. In <i>IPv6 Firewall Configuration</i> there is the ICMPv6 option. |
| Target Port(s) | The target port numbers. Enter the initial and final port numbers separated by the hyphen mark. One static port is allowed as well. |
| Action | Specifies the rule – the type of action the router performs: <ul style="list-style-type: none"> • allow – The router allows the packets to enter the network. • deny – The router denies the packets from entering the network. |
| Description | Description of the rule. |

Table 29: Forwarding filtering

When you enable the *Enable filtering of locally destined packets* function, the router drops the packets requesting an unsupported service. The packet is dropped automatically without any information.

As a protection against DoS attacks, the *Enable protection against DoS attacks* limits the number of allowed connections per second to five. The DoS attack floods the target system with meaningless requirements.

4.7.1 Example of the IPv4 Firewall Configuration

The router allows the following access:

- From IP address 171.92.5.45 using any protocol.
- From IP address 10.0.2.123 using the TCP protocol on port 1000.
- From IP address 142.2.26.54 using the ICMP protocol.
- from IP address 142.2.26.54 using the TCMP protocol on target ports from 1020 to 1040

See the network topology and configuration form in the figures below.

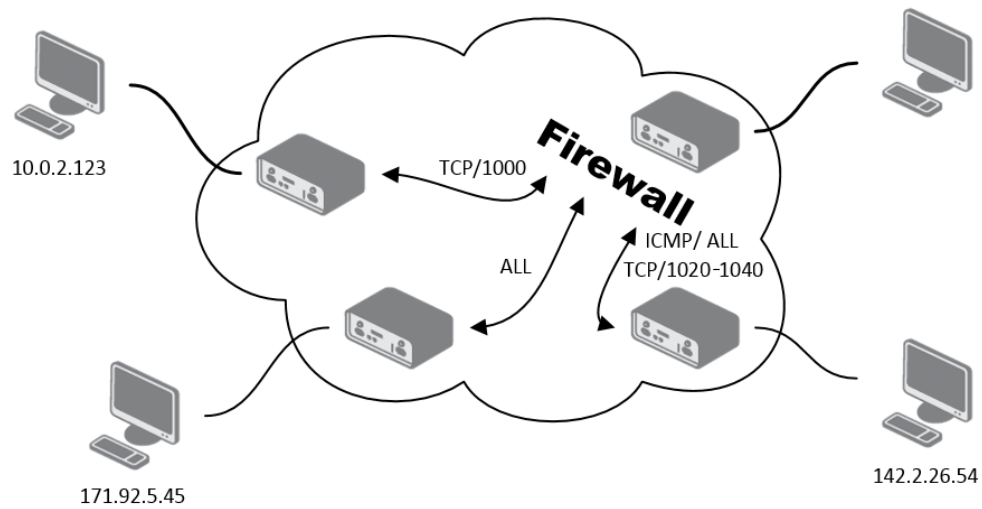

Figure 29: Topology for the IPv4 Firewall Configuration Example

IPv4 Firewall Configuration

Enable filtering of incoming packets

| Source * | Protocol | Target Port(s) * | Action | Description * |
|---|----------|------------------|---------|---------------|
| <input checked="" type="checkbox"/> 171.92.5.45 | all ▾ | | allow ▾ | |
| <input checked="" type="checkbox"/> 10.0.2.123 | TCP ▾ | 1000 | allow ▾ | |
| <input checked="" type="checkbox"/> 142.2.26.54 | ICMP ▾ | | allow ▾ | |
| <input checked="" type="checkbox"/> 142.2.26.54 | TCP ▾ | 1020-1040 | allow ▾ | |
| <input type="checkbox"/> | all ▾ | | allow ▾ | |
| <input type="checkbox"/> | all ▾ | | allow ▾ | |
| <input type="checkbox"/> | all ▾ | | allow ▾ | |
| <input type="checkbox"/> | all ▾ | | allow ▾ | |

Enable filtering of forwarded packets

| Source * | Destination * | Protocol | Target Port(s) * | Action | Description * |
|--------------------------|---------------|----------|------------------|---------|---------------|
| <input type="checkbox"/> | | all ▾ | | allow ▾ | |
| <input type="checkbox"/> | | all ▾ | | allow ▾ | |
| <input type="checkbox"/> | | all ▾ | | allow ▾ | |
| <input type="checkbox"/> | | all ▾ | | allow ▾ | |
| <input type="checkbox"/> | | all ▾ | | allow ▾ | |
| <input type="checkbox"/> | | all ▾ | | allow ▾ | |
| <input type="checkbox"/> | | all ▾ | | allow ▾ | |
| <input type="checkbox"/> | | all ▾ | | allow ▾ | |
| <input type="checkbox"/> | | all ▾ | | allow ▾ | |

Enable filtering of locally destined packets

Enable protection against DoS attacks

* can be blank

Figure 30: IPv4 Firewall Configuration Example

4.8 NAT Configuration

To configure the address translation function, click on *NAT* in the *Configuration* section of the main menu. There is independent IPv4 and IPv6 NAT configuration since there is dual stack IPv4 and IPv6 implemented in the router. The *NAT* item in the menu on the left will expand to *IPv4* and *IPv6* options and you can click *IPv6* to enable and configure the IPv6 NAT – see Figure below. The configuration fields have the same meaning in the *IPv4 NAT Configuration* and *IPv6 NAT Configuration* forms.

The router actually uses Port Address Translation (PAT), which is a method of mapping a TCP/UDP port to another TCP/UDP port. The router modifies the information in the packet header as the packets traverse a router. This configuration form allows you to specify up to 16 PAT rules.

| Item | Description |
|---------------------|--|
| Public Port(s) | The public port numbers range for NAT. Enter the initial and final port numbers separated by the hyphen mark. One static port is allowed as well. |
| Private Port(s) | The private port numbers range for NAT. Enter the initial and final port numbers separated by the hyphen mark. One static port is allowed as well. |
| Type | Protocol type – TCP or UDP. |
| Server IPv4 address | In <i>IPv4 NAT Configuration</i> only. IPv4 address where the router forwards incoming data. |
| Server IPv6 address | In <i>IPv6 NAT Configuration</i> only. IPv6 address where the router forwards incoming data. |
| Description | Description of the rule. |

Table 30: NAT Configuration

If you require more than sixteen NAT rules, insert the remaining rules into the Startup Script. The *Startup Script* dialog is located on *Scripts* page in the *Configuration* section of the menu. When creating your rules in the Startup Script, use this command for IPv4 NAT:



```
iptables -t nat -A pre_nat -p tcp --dport [PORT_PUBLIC] -j DNAT
--to-destination [IPADDR]:[PORT_PRIVATE]
```

Enter the IP address [IPADDR], the public ports numbers [PORT_PUBLIC], and private [PORT_PRIVATE] in place of square brackets.
For IPv6 NAT use `ip6tables` command with same options.:



```
ip6tables -t nat -A napt -p tcp --dport [PORT_PUBLIC] -j DNAT
--to-destination [IP6ADDR]:[PORT_PRIVATE]
```

If you enable the following options and enter the port number, the router allows you to remotely access to the router from WAN (Mobile WAN) interface.

| NAT Configuration | | | | |
|--|-----------------|-------|-------------------|---------------|
| Public Port(s) | Private Port(s) | Type | Server IP Address | Description * |
| 81 | 80 | TCP ▾ | 192.168.1.2 | |
| 82 | 80 | TCP ▾ | 192.168.1.3 | |
| 83 | 80 | TCP ▾ | 192.168.1.4 | |
| | | TCP ▾ | | |
| | | TCP ▾ | | |
| | | TCP ▾ | | |
| | | TCP ▾ | | |
| | | TCP ▾ | | |
| | | TCP ▾ | | |
| | | TCP ▾ | | |
| | | TCP ▾ | | |
| | | TCP ▾ | | |
| | | TCP ▾ | | |
| | | TCP ▾ | | |
| | | TCP ▾ | | |
| | | TCP ▾ | | |
| | | TCP ▾ | | |
| | | TCP ▾ | | |
| | | TCP ▾ | | |
| | | TCP ▾ | | |
| | | TCP ▾ | | |
| | | TCP ▾ | | |
| <input type="checkbox"/> Enable remote HTTP access on port <input type="text" value="80"/> | | | | |
| <input type="checkbox"/> Enable remote HTTPS access on port <input type="text" value="443"/> | | | | |
| <input type="checkbox"/> Enable remote FTP access on port <input type="text" value="21"/> | | | | |
| <input type="checkbox"/> Enable remote SSH access on port <input type="text" value="22"/> | | | | |
| <input type="checkbox"/> Enable remote Telnet access on port <input type="text" value="23"/> | | | | |
| <input type="checkbox"/> Enable remote SNMP access on port <input type="text" value="161"/> | | | | |
| <input type="checkbox"/> Send all remaining incoming packets to default server Default Server IP Address <input type="text"/> | | | | |
| <input type="checkbox"/> Masquerade outgoing packets * can be blank | | | | |
| <input type="button" value="Apply"/> | | | | |

Figure 31: NAT – IPv6 NAT Configuration

| Item | Description |
|--|--|
| Enable remote HTTP access on port | This option sets the redirect from HTTP to HTTPS only (disabled in default configuration). |
| Enable remote HTTPS access on port | If field and port number are filled in, configuration of the router over web interface is allowed (disabled in default configuration). |
| Enable remote FTP access on port | Select this option to allow access to the router using FTP (disabled in default configuration). |
| Enable remote SSH access on port | Select this option to allow access to the router using SSH (disabled in default configuration). |
| Enable remote Telnet access on port | Select this option to allow access to the router using Telnet (disabled in default configuration). |
| Enable remote SNMP access on port | Select this option to allow access to the router using SNMP (disabled in default configuration). |
| Masquerade outgoing packets | Activates/deactivates the network address translation function. |

Table 31: Remote Access Configuration



Enable remote HTTP access on port activates **the redirect from HTTP to HTTPS protocol only**. The router doesn't allow unsecured HTTP protocol to access the web configuration. To access the web configuration, always check the *Enable remote HTTPS access on port* item. Never enable the HTTP item only to access the web configuration from the Internet (configuration would not be accessible from the Internet). Always check the HTTPS item or HTTPS and HTTP items together (to set the redirect from HTTP).

Use the following parameters to set the routing of incoming data from the WAN (Mobile WAN) to a connected computer.

| Item | Description |
|---|--|
| Send all remaining incoming packets to default server | Activates/deactivates forwarding unmatched incoming packets to the default server. The prerequisite for the function is that you specify a default server in the <i>Default Server IPv4/IPv6 Address</i> field. The router can forward incoming data from a mobile WAN to a computer with the assigned IP address. |
| Default Server IP Address | In <i>IPv4 NAT Configuration</i> only. The IPv4 address. |
| Default Server IPv6 Address | In <i>IPv6 NAT Configuration</i> only. The IPv6 address. |

Table 32: Configuration of Send all incoming packets to server

4.8.1 Examples of NAT Configuration

Example 1: IPv4 NAT Configuration with Single Device Connected

It is important to mark the *Send all remaining incoming packets to default server* check box for this configuration. The IP address in this example is the address of the device behind the router. The default gateway of the devices in the subnetwork connected to router is the same IP address as displayed in the *Default Server IPv4 Address* field. The connected device replies if a PING is sent to the IP address of the SIM card.

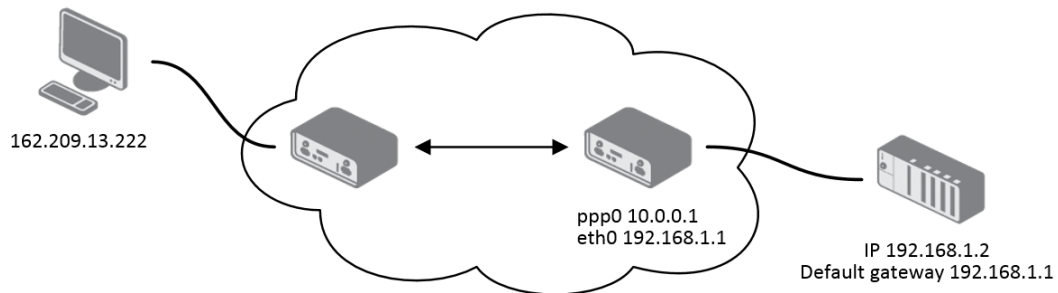

Figure 32: Topology for NAT Configuration Example 1

| IPv4 NAT Configuration | | | | |
|------------------------|----------------------|-------|----------------------|----------------------|
| Public Port(s) | Private Port(s) | Type | Server IP Address | Description * |
| <input type="text"/> | <input type="text"/> | TCP ▾ | <input type="text"/> | <input type="text"/> |
| <input type="text"/> | <input type="text"/> | TCP ▾ | <input type="text"/> | <input type="text"/> |
| <input type="text"/> | <input type="text"/> | TCP ▾ | <input type="text"/> | <input type="text"/> |
| <input type="text"/> | <input type="text"/> | TCP ▾ | <input type="text"/> | <input type="text"/> |
| <input type="text"/> | <input type="text"/> | TCP ▾ | <input type="text"/> | <input type="text"/> |
| <input type="text"/> | <input type="text"/> | TCP ▾ | <input type="text"/> | <input type="text"/> |
| <input type="text"/> | <input type="text"/> | TCP ▾ | <input type="text"/> | <input type="text"/> |
| <input type="text"/> | <input type="text"/> | TCP ▾ | <input type="text"/> | <input type="text"/> |
| <input type="text"/> | <input type="text"/> | TCP ▾ | <input type="text"/> | <input type="text"/> |
| <input type="text"/> | <input type="text"/> | TCP ▾ | <input type="text"/> | <input type="text"/> |
| <input type="text"/> | <input type="text"/> | TCP ▾ | <input type="text"/> | <input type="text"/> |
| <input type="text"/> | <input type="text"/> | TCP ▾ | <input type="text"/> | <input type="text"/> |
| <input type="text"/> | <input type="text"/> | TCP ▾ | <input type="text"/> | <input type="text"/> |
| <input type="text"/> | <input type="text"/> | TCP ▾ | <input type="text"/> | <input type="text"/> |
| <input type="text"/> | <input type="text"/> | TCP ▾ | <input type="text"/> | <input type="text"/> |
| <input type="text"/> | <input type="text"/> | TCP ▾ | <input type="text"/> | <input type="text"/> |
| <input type="text"/> | <input type="text"/> | TCP ▾ | <input type="text"/> | <input type="text"/> |
| <input type="text"/> | <input type="text"/> | TCP ▾ | <input type="text"/> | <input type="text"/> |
| <input type="text"/> | <input type="text"/> | TCP ▾ | <input type="text"/> | <input type="text"/> |
| <input type="text"/> | <input type="text"/> | TCP ▾ | <input type="text"/> | <input type="text"/> |
| <input type="text"/> | <input type="text"/> | TCP ▾ | <input type="text"/> | <input type="text"/> |
| <input type="text"/> | <input type="text"/> | TCP ▾ | <input type="text"/> | <input type="text"/> |
| <input type="text"/> | <input type="text"/> | TCP ▾ | <input type="text"/> | <input type="text"/> |
| <input type="text"/> | <input type="text"/> | TCP ▾ | <input type="text"/> | <input type="text"/> |

Enable remote HTTP access on port

Enable remote HTTPS access on port

Enable remote FTP access on port

Enable remote SSH access on port

Enable remote Telnet access on port

Enable remote SNMP access on port

Send all remaining incoming packets to default server
 Default Server IP Address

Masquerade outgoing packets
** can be blank*

Figure 33: NAT Configuration for Example 1

Example 2: IPv4 NAT Configuration with More Equipment Connected

In this example, using the switch you can connect more devices behind the router. Every device connected behind the router has its own IP address. Enter the address in the *Server IPv Address* field in the NAT dialog. The devices are communicating on port 80, but you can set port forwarding using the *Public Port* and *Private Port* fields in the NAT dialog. You have now configured the router to access the 192.168.1.2:80 socket behind the router when accessing the IP address 10.0.0.1:81 from the Internet. If you send a ping request to the public IP address of the router (10.0.0.1), the router responds as usual (not forwarding). And since the *Send all remaining incoming packets to default server* is inactive, the router denies connection attempts.

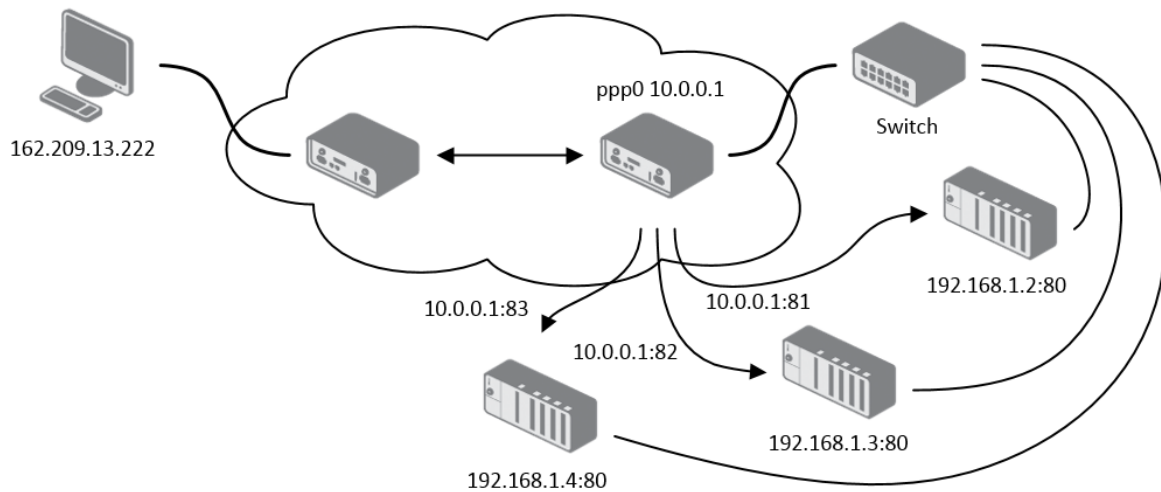

Figure 34: Topology for NAT Configuration Example 2

| IPv4 NAT Configuration | | | | |
|------------------------|-----------------|-------|-------------------|---------------|
| Public Port(s) | Private Port(s) | Type | Server IP Address | Description * |
| 81 | 80 | TCP ▾ | 192.168.1.2 | |
| 82 | 80 | TCP ▾ | 192.168.1.3 | |
| 83 | 80 | TCP ▾ | 192.168.1.4 | |
| | | TCP ▾ | | |
| | | TCP ▾ | | |
| | | TCP ▾ | | |
| | | TCP ▾ | | |
| | | TCP ▾ | | |
| | | TCP ▾ | | |
| | | TCP ▾ | | |
| | | TCP ▾ | | |
| | | TCP ▾ | | |
| | | TCP ▾ | | |
| | | TCP ▾ | | |
| | | TCP ▾ | | |
| | | TCP ▾ | | |
| | | TCP ▾ | | |
| | | TCP ▾ | | |
| | | TCP ▾ | | |
| | | TCP ▾ | | |
| | | TCP ▾ | | |
| | | TCP ▾ | | |

Enable remote HTTP access on port
 Enable remote HTTPS access on port
 Enable remote FTP access on port
 Enable remote SSH access on port
 Enable remote Telnet access on port
 Enable remote SNMP access on port

Send all remaining incoming packets to default server
 Default Server IP Address

Masquerade outgoing packets
 * can be blank

Figure 35: NAT Configuration for Example 2

4.9 OpenVPN Tunnel Configuration

Select the *OpenVPN* item to configure an OpenVPN tunnel. The menu item will expand and you will see four separate configuration pages: *1st Tunnel*, *2nd Tunnel*, *3rd Tunnel* and *4th Tunnel*. The OpenVPN tunnel function allows you to create a secure connection between two separate LAN networks. The router allows you to create up to four OpenVPN tunnels. IPv4 and IPv6 dual stack is supported.

| Item | Description |
|-----------------------------|--|
| Description | Specifies the description or name of tunnel. |
| Protocol | Specifies the communication protocol. <ul style="list-style-type: none"> • UDP – The OpenVPN communicates using UDP. • TCP server – The OpenVPN communicates using TCP in server mode. • TCP client – The OpenVPN communicates using TCP in client mode. • UDPv6 – The OpenVPN communicates using UDP over IPv6. • TCPv6 server – The OpenVPN communicates using TCP over IPv6 in server mode. • TCPv6 client – The OpenVPN communicates using TCP over IPv6 in client mode. |
| UDP/TCP port | Specifies the port of the relevant protocol (UDP or TCP). |
| Remote IP Address | Specifies the IPv4, IPv6 address or domain name of the opposite side of the tunnel. |
| Remote Subnet | IPv4 address of a network behind opposite side of the tunnel. |
| Remote Subnet Mask | IPv4 subnet mask of a network behind opposite tunnel's side. |
| Redirect Gateway | Adds (rewrites) the default gateway. All the packets are then sent to this gateway via tunnel, if there is no other specified default gateway inside them. |
| Local Interface IP Address | Specifies the IPv4 address of a local interface. For proper routing it is recommended to fill-in any IPv4 address from local range even if you are using IPv6 tunnel only. |
| Remote Interface IP Address | Specifies the IPv4 address of the interface of opposite side of the tunnel. For proper routing it is recommended to fill-in any IPv4 address from local range even if you are using IPv6 tunnel only. |

Continued on next page

Continued from previous page

| Item | Description |
|-------------------------------|--|
| Remote IPv6 Subnet | IPv6 address of the remote IPv6 network. Equivalent of the <i>Remote Subnet</i> in IPv4 section. |
| Remote IPv6 Prefix | IPv6 prefix of the remote IPv6 network. Equivalent of the <i>Remote Subnet Mask</i> in IPv4 section. |
| Local Interface IPv6 Address | Specifies the IPv6 address of a local interface. |
| Remote Interface IPv6 Address | Specifies the IPv6 address of the interface of opposite side of the tunnel. |
| Ping Interval | Time interval after which the router sends a message to opposite side of tunnel to verify the existence of the tunnel. |
| Ping Timeout | Specifies the time interval the router waits for a message sent by the opposite side. For proper verification of the OpenVPN tunnel, set the <i>Ping Timeout</i> to greater than the <i>Ping Interval</i> . |
| Renegotiate Interval | Specifies the renegotiate period (reauthorization) of the OpenVPN tunnel. You can only set this parameter when the <i>Authenticate Mode</i> is set to <i>username/password</i> or <i>X.509 certificate</i> . After this time period, the router changes the tunnel encryption to keep the tunnel secure. |
| Max Fragment Size | Maximum size of a sent packet. |
| Compression | Compression of the data sent: <ul style="list-style-type: none"> • none – No compression is used. • LZO – A lossless compression is used, use the same setting on both sides of the tunnel. |
| NAT Rules | Activates/deactivates the NAT rules for the OpenVPN tunnel: <ul style="list-style-type: none"> • not applied – NAT rules are not applied to the tunnel. • applied – NAT rules are applied to the OpenVPN tunnel. |

Continued on next page

Continued from previous page

| Item | Description |
|-------------------|--|
| Authenticate Mode | <p>Specifies the authentication mode:</p> <ul style="list-style-type: none"> • none – No authentication is set. • Pre-shared secret – Specifies the shared key function for both sides of the tunnel. • Username/password – Specifies authentication using a CA Certificate, Username and Password. • X.509 Certificate (multiclient) – Activates the X.509 authentication in multi-client mode. • X.509 Certificate (client) – Activates the X.509 authentication in client mode. • X.509 Certificate (server) – Activates the X.509 authentication in server mode. |
| Security Mode | <p>Choose the security mode, <i>tls-auth</i> or <i>tls-crypt</i>. We recommend to use the <i>tls-crypt</i> mode for the security reasons. In this mode, all the data is encrypted with a pre-shared key. Moreover, this mode is more robust against the TLS denial of service attacks.</p> |
| Pre-shared Secret | <p>Specifies the pre-shared secret which you can use for every authentication mode.</p> |
| CA Certificate | <p>Specifies the CA Certificate which you can use for the username/password and X.509 Certificate authentication modes.</p> |
| DH Parameters | <p>Specifies the protocol for the DH parameters key exchange which you can use for X.509 Certificate authentication in the server mode.</p> |
| Local Certificate | <p>Specifies the certificate used in the local device. You can use this authentication certificate for the X.509 Certificate authentication mode.</p> |
| Local Private Key | <p>Specifies the key used in the local device. You can use the key for the X.509 Certificate authentication mode.</p> |
| Username | <p>Specifies a login name which you can use for authentication in the username/password mode.</p> |
| Password | <p>Specifies a password which you can use for authentication in the username/password mode. Enter valid characters only, see chap. 2.3!</p> |

Continued on next page

Continued from previous page

| Item | Description |
|---------------|--|
| Extra Options | Specifies additional parameters for the OpenVPN tunnel, such as DHCP options. The parameters are proceeded by two dashes. For possible parameters see the help text in the router using SSH – run the <code>openvpn --help</code> command. |

Table 33: OpenVPN Configuration



There is a condition for tunnel to be established: WAN route has to be active (for example mobile connection established) even if the tunnel does not go through the WAN.

The changes in settings will apply after pressing the *Apply* button.

| 1st OpenVPN Tunnel Configuration | |
|--|----------------------------|
| <input type="checkbox"/> Create 1st OpenVPN tunnel | |
| Description * | <input type="text"/> |
| Protocol | UDP ▼ |
| UDP Port | 1194 |
| Remote IP Address * | <input type="text"/> |
| Remote Subnet * | <input type="text"/> |
| Remote Subnet Mask * | <input type="text"/> |
| Redirect Gateway | no ▼ |
| Local Interface IP Address | <input type="text"/> |
| Remote Interface IP Address | <input type="text"/> |
| Remote IPv6 Subnet * | <input type="text"/> |
| Remote IPv6 Subnet Prefix Length * | <input type="text"/> |
| Local Interface IPv6 Address * | <input type="text"/> |
| Remote Interface IPv6 Address * | <input type="text"/> |
| Ping Interval * | <input type="text"/> sec |
| Ping Timeout * | <input type="text"/> sec |
| Renegotiate Interval * | <input type="text"/> sec |
| Max Fragment Size * | <input type="text"/> bytes |
| Compression | LZO ▼ |
| NAT Rules | not applied ▼ |
| Authenticate Mode | none ▼ |
| Security Mode | tls-auth ▼ |
| Pre-shared Secret | <input type="text"/> |
| CA Certificate | <input type="text"/> |
| DH Parameters | <input type="text"/> |
| Local Certificate | <input type="text"/> |
| Local Private Key | <input type="text"/> |
| Username | <input type="text"/> |
| Password | <input type="text"/> |
| Extra Options * | <input type="text"/> |
| * can be blank | |
| <input type="button" value="Apply"/> | |

Figure 36: OpenVPN tunnel configuration

4.9.1 Example of the OpenVPN Tunnel Configuration in IPv4 Network

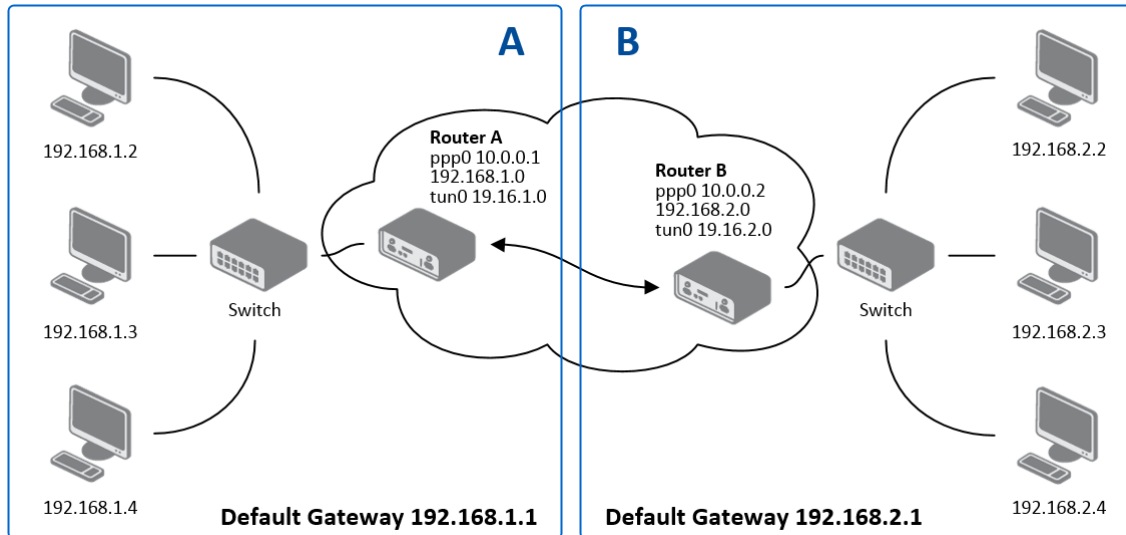

Figure 37: Topology of OpenVPN Configuration Example

OpenVPN tunnel configuration:

| Configuration | A | B |
|-----------------------------|---------------|---------------|
| Protocol | UDP | UDP |
| UDP Port | 1194 | 1194 |
| Remote IP Address | 10.0.0.2 | 10.0.0.1 |
| Remote Subnet | 192.168.2.0 | 192.168.1.0 |
| Remote Subnet Mask | 255.255.255.0 | 255.255.255.0 |
| Local Interface IP Address | 19.16.1.0 | 19.16.2.0 |
| Remote Interface IP Address | 19.16.2.0 | 19.16.1.0 |
| Compression | LZO | LZO |
| Authenticate mode | none | none |

Table 34: OpenVPN Configuration Example



Examples of different options for configuration and authentication of OpenVPN tunnel can be found in the application note *OpenVPN Tunnel* [4].

4.10 IPsec Tunnel Configuration

The IPsec tunnel function allows you to create a secured connection between two separate LAN networks. Advantech routers allows you to create **up to four IPsec tunnels**.

To open the IPsec tunnel configuration page, click *IPsec* in the *Configuration* section of the main menu. The menu item will expand and you will see four separate configuration pages: *1st Tunnel*, *2nd Tunnel*, *3rd Tunnel* and *4th Tunnel*. Supported are both, **policy-based** and **route-based** VPN approaches, see the different configuration scenarios in Chapter 4.10.1.

IPv4 and IPv6 tunnels are supported (**dual stack**), you can transport IPv6 traffic through IPv4 tunnel and vice versa. For different IPsec authentication scenarios, see Chapter 4.10.2.



To encrypt data between the local and remote subnets, specify the appropriate values in the subnet fields on both routers. To encrypt the data stream between the routers only, leave the local and remote subnets fields blank.



If you specify the protocol and port information in the *Local Protocol/Port* field, then the router encapsulates only the packets matching the settings.



For optimal an secure setup, we recommend to follow instructions on the [Security Recommendations](#) *strongSwan* web page.



[FRRouting \(FRR\)](#) user module is an Internet routing protocol suite for Advantech routers. This UM includes protocol daemons for BGP, IS-IS, LDP, OSPF, PIM, and RIP.

4.10.1 Route-based Configuration Scenarios

There are more different route-based configuration options which can be configured and used in Advantech routers. Below are listed the most common cases which can be used (for more details see [Route-based VPNs](#) *strongSwan* web page):

1. Enabled Installing Routes

- Remote (local) subnets are used as traffic selectors (routes).
- It results to the same outcome as a policy-based VPN.
- One benefit of this approach is the possibility to verify non-encrypted traffic passed through an IPsec tunnel number X by tcpdump tool: `tcpdump -i ipsecX`.
- Set up the *Install Routes* to *yes* option.

2. Static Routes

- Routes are installed statically by an application as soon as the IPsec tunnel is up.
- As an application for static routes installation can be used for example FRR/STATICD application.
- Set up the *Install Routes* to *no* option.

3. Dynamic Routing

- Routes are installed dynamically while running by an application using a dynamic protocol.
- As an application for dynamic routes installation can be used for example FRR/BGP or FRR/OSPF application. This application gains the routes dynamically from an (BGP, OSPF) server.
- Set up the *Install Routes* to *no* option.

4. Multiple Clients

- Allows to create VPN network with multiple clients. One Advantech router acts as the server and assigns IP address to all the clients on the network.
- The server has *Remote Virtual Network* and *Remote Virtual Mask* items configured and the client has *Local Virtual Address* item configured.
- Set up the *Install Routes* to *yes* option.

4.10.2 IPsec Authentication Scenarios

There are four basic authentication options which can be configured and used in Advantech routers:

1. Pre-shared Key

- Set *Authenticate Mode* to *pre-shared key* option.
- Enter the shared key to the *Pre-shared key* field.

2. Public Key

- Set *Authenticate Mode* to *X.509 certificate* option.
- Enter the public key to the *Local Certificate / PubKey* field.
- CA certificate is not required.

3. Peer Certificate

- Set *Authenticate Mode* to *X.509 certificate* option.
- Enter the remote key to the *Remote Certificate / PubKey* field. Users with this certificate will be allowed.
- CA certificate is not required.

4. CA Certificate

- Set *Authenticate Mode* to *X.509 certificate* option.
- Enter the CA certificate or a list of CA certificates to the *CA Certificate* field. Any certificate signed by the CA will be accepted.
- Remote certificate is not required.

Notes:

- The Peer and CA Certificate (options 3 and 4) can be configured and used simultaneously – authentication can be done by one of this method.
- The Local ID is significant. When using certificate authentication, the IKE identity must be contained in the certificate, either as subject or as `subjectAltName`.

4.10.3 Configuration Items Description

The configuration GUI for IPsec is shown in Figure 38 and the description of all items, which can be configured for an IPsec tunnel, are described in Table 35.

| 1st IPsec Tunnel Configuration | |
|--|--|
| <input type="checkbox"/> Create 1st IPsec tunnel | |
| Description * | <input type="text"/> |
| Type | policy-based ▼ |
| Host IP Mode | IPv4 ▼ |
| Remote IP Address * | <input type="text"/> |
| 1st Remote IP Address * | <input type="text"/> |
| 2nd Remote IP Address * | <input type="text"/> |
| Tunnel IP Mode | IPv4 ▼ |
| Remote ID * | <input type="text"/> |
| Local ID * | <input type="text"/> |
| Install Routes | yes ▼ |
| First Remote Subnet * | <input type="text"/> |
| First Remote Subnet Mask * | <input type="text"/> |
| Second Remote Subnet * | <input type="text"/> |
| Second Remote Subnet Mask * | <input type="text"/> |
| Remote Protocol/Port * | <input type="text"/> |
| First Local Subnet * | <input type="text"/> |
| First Local Subnet Mask * | <input type="text"/> |
| Second Local Subnet * | <input type="text"/> |
| Second Local Subnet Mask * | <input type="text"/> |
| Local Protocol/Port * | <input type="text"/> |
| Remote Virtual Network * | <input type="text"/> |
| Remote Virtual Mask * | <input type="text"/> |
| Local Virtual Address * | <input type="text"/> |
| Cisco FlexVPN ** | no ▼ |
| Encapsulation Mode | tunnel ▼ |
| Force NAT Traversal | no ▼ |
| IKE Protocol | IKEv1 ▼ |
| IKE Mode | main ▼ |
| IKE Algorithm | auto ▼ |
| IKE Encryption | 3DES ▼ |
| IKE Hash | MD5 ▼ |
| IKE DH Group | 2 ▼ |
| IKE Reauthentication | yes ▼ |
| XAUTH Enabled | no ▼ |
| XAUTH Mode | client ▼ |
| XAUTH Username | <input type="text"/> |
| XAUTH Password | <input type="text"/> |
| ESP Algorithm | auto ▼ |
| ESP Encryption | DES ▼ |
| ESP Hash | MD5 ▼ |
| PFS | disabled ▼ |
| PFS DH Group | 2 ▼ |
| Key Lifetime | 3600 sec |
| IKE Lifetime | 3600 sec |
| Rekey Margin | 540 sec |
| Rekey Fuzz | 100 % |
| DPD Delay * | <input type="text"/> sec |
| DPD Timeout * | <input type="text"/> sec |
| Authenticate Mode | pre-shared key ▼ |
| Pre-shared Key | <input type="text"/> |
| CA Certificate * | <input type="text"/> Choose File No file chosen |
| Remote Certificate / PubKey * | <input type="text"/> Choose File No file chosen |
| Local Certificate / PubKey | <input type="text"/> Choose File No file chosen |
| Local Private Key | <input type="text"/> Choose File No file chosen |
| Local Passphrase * | <input type="text"/> |
| Revocation Check | if possible ▼ |
| Debug ** | control ▼ |
| * can be blank | |
| ** affects all tunnels | |
| <input type="button" value="Apply"/> | |

Figure 38: IPsec Tunnels Configuration

| Item | Description |
|----------------------------------|---|
| Description | Name or description of the tunnel. |
| Type | <ul style="list-style-type: none"> ● policy-based – Choose for the policy-based VPN approach. ● route-based – Choose for the route-based VPN approach. Note: Data throughput via route-based VPN is slightly lower in comparison with policy-based VPN. |
| Host IP Mode | <ul style="list-style-type: none"> ● IPv4 – The router communicates via IPv4 with the opposite side of the tunnel. ● IPv6 – The router communicates via IPv6 with the opposite side of the tunnel. |
| 1st Remote IP Address | First IPv4, IPv6 address or domain name of the remote side of the tunnel, based on selected <i>Host IP Mode</i> above. |
| 2nd Remote IP Address | Second IPv4, IPv6 address or domain name of the remote side of the tunnel, based on selected <i>Host IP Mode</i> above. |
| Tunnel IP Mode | <ul style="list-style-type: none"> ● IPv4 – The IPv4 communication runs inside the tunnel. ● IPv6 – The IPv6 communication runs inside the tunnel. |
| Remote ID | Identifier (ID) of remote side of the tunnel. It consists of two parts: a <i>hostname</i> and a <i>domain-name</i> . |
| Local ID | Identifier (ID) of local side of the tunnel. It consists of two parts: a <i>hostname</i> and a <i>domain-name</i> . |
| Install Routers | For route-based type only. Choose yes to use traffic selectors as route(s). |
| First Remote Subnet | IPv4 or IPv6 address of a network behind remote side of the tunnel, based on <i>Tunnel IP Mode</i> above. |
| First Remote Subnet Mask/Prefix | IPv4 subnet mask of a network behind remote side of the tunnel, or IPv6 prefix (single number 0 to 128). |
| Second Remote Subnet | IPv4 or IPv6 address of the second network behind remote side of the tunnel, based on <i>Tunnel IP Mode</i> above. For <i>IKE Protocol = IKEv2</i> only. |
| Second Remote Subnet Mask/Prefix | IPv4 subnet mask of the second network behind remote side of the tunnel, or IPv6 prefix (single number 0 to 128). For <i>IKE Protocol = IKEv2</i> only. |
| Remote Protocol/Port | Specifies Protocol/Port of remote side of the tunnel. The general form is <i>protocol/port</i> , for example 17/1701 for UDP (protocol 17) and port 1701. It is also possible to enter only the number of protocol, however, the above mentioned format is preferred. |
| First Local Subnet | IPv4 or IPv6 address of a local network, based on <i>Tunnel IP Mode</i> above. |

Continued on next page

Continued from previous page

| Item | Description |
|---------------------------------|---|
| First Local Subnet Mask/Prefix | IPv4 subnet mask of a local network, or IPv6 prefix (single number 0 to 128). |
| Second Local Subnet | IPv4 or IPv6 address of the second local network, based on <i>Tunnel IP Mode</i> above. For <i>IKE Protocol</i> = IKEv2 only. |
| Second Local Subnet Mask/Prefix | IPv4 subnet mask of the second local network, or IPv6 prefix (single number 0 to 128). For <i>IKE Protocol</i> = IKEv2 only. |
| Local Protocol/Port | Specifies Protocol/Port of a local network. The general form is <i>protocol/port</i> , for example 17/1701 for UDP (protocol 17) and port 1701. It is also possible to enter only the number of protocol, however, the above mentioned format is preferred. |
| Remote Virtual Network | Specifies virtual remote network for server (responder). |
| Remote Virtual Mask | Specifies virtual remote network mask for server (responder). |
| Local Virtual Address | Specifies virtual local network address for client. To get address from server set up the address to 0.0.0.0. |
| Cisco FlexVPN | Enable to support the Cisco FlexVPN functionality. The <i>route-based</i> type must be chosen. For more information, see strongswan.conf page. |
| Encapsulation Mode | Specifies the IPsec mode, according to the method of encapsulation. <ul style="list-style-type: none"> • tunnel – entire IP datagram is encapsulated. • transport – only IP header is encapsulated. Not supported by route-based VPN. • beet – the ESP packet is formatted as a transport mode packet, but the semantics of the connection are the same as for tunnel mode. |
| Force NAT Traversal | Enable NAT traversal enforcement (UDP encapsulation of ESP packets). |
| IKE Protocol | Specifies the version of IKE (IKEv1/IKEv2 , IKEv1 or IKEv2). |
| IKE Mode | Specifies the mode for establishing a connection (<i>main</i> or <i>aggressive</i>). If you select the aggressive mode, then the router establishes the IPsec tunnel faster, but the encryption is permanently set to 3DES-MD5. We recommend that you not use the aggressive mode due to lower security! |

Continued on next page

Continued from previous page

| Item | Description |
|----------------------|--|
| IKE Algorithm | Specifies the means by which the router selects the algorithm: <ul style="list-style-type: none"> • auto – The encryption and hash algorithm are selected automatically. • manual – The encryption and hash algorithm are defined by the user. |
| IKE Encryption | Encryption algorithm – 3DES, AES128, AES192, AES256, AES128GCM128, AES192GCM128, AES256GCM128. |
| IKE Hash | Hash algorithm – MD5, SHA1, SHA256, SHA384 or SHA512. |
| IKE DH Group | Specifies the Diffie-Hellman groups which determine the strength of the key used in the key exchange process. Higher group numbers are more secure, but require more time to compute the key. |
| IKE Reauthentication | Enable or disable IKE reauthentication (for IKEv2 only). |
| XAUTH Enabled | Enable extended authentication (for IKEv1 only). |
| XAUTH Mode | Select XAUTH mode (client or server). |
| XAUTH Username | XAUTH username. |
| XAUTH Password | XAUTH password. |
| ESP Algorithm | Specifies the means by which the router selects the algorithm: <ul style="list-style-type: none"> • auto – The encryption and hash algorithm are selected automatically. • manual – The encryption and hash algorithm are defined by the user. |
| ESP Encryption | Encryption algorithm – 3DES, AES128, AES192, AES256, AES128GCM128, AES192GCM128, AES256GCM128. |
| ESP Hash | Hash algorithm – MD5, SHA1, SHA256, SHA384 or SHA512. |
| PFS | Enables/disables the <i>Perfect Forward Secrecy</i> function. The function ensures that derived session keys are not compromised if one of the private keys is compromised in the future. |
| PFS DH Group | Specifies the Diffie-Hellman group number (see <i>IKE DH Group</i>). |
| Key Lifetime | Lifetime key data part of tunnel. The minimum value of this parameter is 60 s. The maximum value is 86400 s. |
| IKE Lifetime | Lifetime key service part of tunnel. The minimum value of this parameter is 60 s. The maximum value is 86400 s. |
| Rekey Margin | Specifies how long before a connection expires that the router attempts to negotiate a replacement. Specify a maximum value that is less than half of IKE and Key Lifetime parameters. |
| Rekey Fuzz | Percentage of time for the Rekey Margin extension. |

Continued on next page

Continued from previous page

| Item | Description |
|-----------------------------|--|
| DPD Delay | Time after which the IPsec tunnel functionality is tested. |
| DPD Timeout | The period during which device waits for a response. |
| Authenticate Mode | Specifies the means by which the router authenticates: <ul style="list-style-type: none"> • Pre-shared key – Sets the shared key for both sides of the tunnel. • X.509 Certificate – Allows X.509 authentication in multiclient mode. |
| Pre-shared Key | Specifies the shared key for both sides of the tunnel. The prerequisite for entering a key is that you select pre-shared key as the authentication mode. |
| CA Certificate | Certificate for X.509 authentication. |
| Remote Certificate \ PubKey | Certificate for X.509 authentication or PubKey for public key signature authentication. |
| Local Certificate \ PubKey | Certificate for X.509 authentication or PubKey for public key signature authentication. |
| Local Private Key | Private key for X.509 authentication. |
| Local Passphrase | Passphrase used during private key generation. |
| Revocation Check | Certificate revocation policy: <ul style="list-style-type: none"> • if possible – Fails only if a certificate is revoked, i.e. it is explicitly known that it is bad. • if URI defined – Fails only if a CRL/OCSP URI is available, but certificate revocation checking fails, i.e. there should be revocation information available, but it could not be obtained. • always – Fails if no revocation information is available, i.e. the certificate is not known to be unrevoked. |
| Debug | Choose the level of logging verbosity from: silent , audit , control (default), control-more , raw , private (most verbose including the private keys). See Logger Configuration in <i>strongSwan</i> web page for more details. |

Table 35: IPsec Tunnel Configuration

We recommend that you keep up the default settings. When you set key exchange times higher, the tunnel produces lower operating costs, but the setting also provides less security. Conversely, when you reducing the time, the tunnel produces higher operating costs, but provides for higher security. The changes in settings will apply after clicking the *Apply* button.

**Do not miss:**

- If local and remote subnets are not configured then only packets between local and remote IP address are encapsulated, so only communication between two routers is encrypted.
- If protocol/port fields are configured then only packets matching these settings are encapsulated.



Detailed information and more examples of IPsec tunnel configuration and authentication can be found in the application note *IPsec Tunnel* [5].

4.10.4 Basic IPv4 IPsec Tunnel Configuration

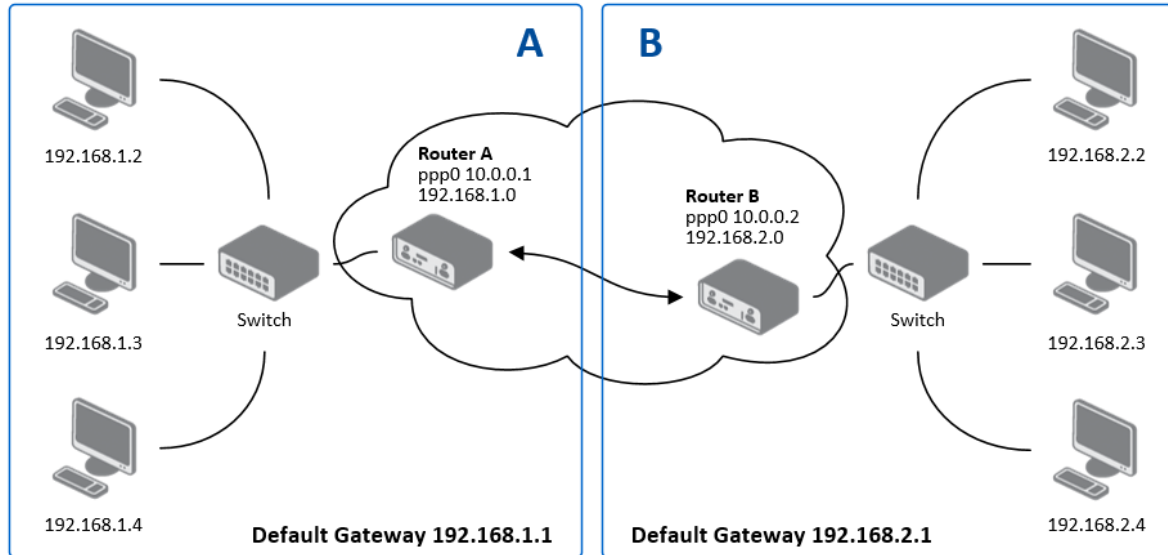

Figure 39: Topology of IPsec Configuration Example

Configuration of *Router A* and *Router B* is as follows:

| Configuration | A | B |
|--------------------------|----------------|----------------|
| Host IP Mode | IPv4 | IPv4 |
| 1st Remote IP Address | 10.0.0.2 | 10.0.0.1 |
| Tunnel IP Mode | IPv4 | IPv4 |
| First Remote Subnet | 192.168.2.0 | 192.168.1.0 |
| First Remote Subnet Mask | 255.255.255.0 | 255.255.255.0 |
| First Local Subnet | 192.168.1.0 | 192.168.2.0 |
| First Local Subnet Mask | 255.255.255.0 | 255.255.255.0 |
| Authenticate mode | pre-shared key | pre-shared key |
| Pre-shared key | test | test |

Table 36: Simple IPv4 IPsec Tunnel Configuration

4.11 WireGuard Tunnel Configuration

WireGuard is a communication protocol and free open-source software that implements encrypted virtual private networks (VPNs), and was designed with the goals of ease of use, high speed performance, and low attack surface. It aims for better performance and more power than IPsec and OpenVPN, two common tunneling protocols. The WireGuard protocol passes traffic over UDP. Advantech routers allows you to create **up to four WireGuard tunnels**.

To open the WireGuard tunnel configuration page, click *WireGuard* in the *Configuration* section of the main menu. The menu item will expand and you will see four separate configuration pages: *1st Tunnel*, *2nd Tunnel*, *3rd Tunnel* and *4th Tunnel*.

IPv4 and IPv6 tunnels are supported (**dual stack**), you can transport IPv6 traffic through IPv4 tunnel and vice versa.



FRRouting (FRR) user module is an Internet routing protocol suite for Advantech routers. This UM includes protocol daemons for BGP, IS-IS, LDP, OSPF, PIM, and RIP.



Detailed information and more examples of WireGuard tunnel configuration and authentication can be found in the application note *WireGuard Tunnel* [7].

The configuration GUI for WireGuard is shown in Figure 40 and the description of all items, which can be configured for an WireGuard tunnel, are described in Table 37.

1st WireGuard Tunnel Configuration

Create 1st WireGuard tunnel
 Description *
 Host IP Mode ▼
 Remote IP Address *
 Remote Port *
 Local Port
 NAT/Firewall Traversal ▼

Interface IPv4 Address *
 Interface IPv4 Prefix Length *
 Interface IPv6 Address *
 Interface IPv6 Prefix Length *

Install Routes ▼
 Traffic Selector ▼
 Remote Subnets *

Pre-shared Key *
 Local Private Key
 Local Public Key *
 Remote Public Key
* can be blank

Figure 40: WireGuard Tunnels Configuration

| Item | Description |
|-------------------|--|
| Description | Name or description of the tunnel. |
| Host IP Mode | <ul style="list-style-type: none"> ● IPv4 – The router communicates via IPv4 with the opposite side of the tunnel. ● IPv6 – The router communicates via IPv6 with the opposite side of the tunnel. |
| Remote IP Address | IPv4, IPv6 address or domain name of the remote side of the tunnel to connect to. The address must match with the selected <i>Host IP Mode</i> above. |
| Remote Port | Port of the remote side of the tunnel. |

Continued on next page

Continued from previous page

| Item | Description |
|------------------------------|--|
| Local Port | Port of the local side of the tunnel (default port is 51820). |
| NAT/Firewall Traversal | If set up to <i>yes</i> , keepalive communication (every 25 seconds) is running to preserve the tunnel established. It is useful when a client is running behind the NAT. |
| Interface IPv4 Address | Local IPv4 tunnel interface address. |
| Interface IPv4 Prefix Length | Local IPv4 tunnel interface prefix. |
| Interface IPv6 Address | Local IPv6 tunnel interface address. |
| Interface IPv6 Prefix Length | Local IPv6 tunnel interface prefix. |
| Install Routes | <ul style="list-style-type: none"> • no – Do not install routes. Use when a dynamic routing protocol is configured. • yes – Install routes. |
| Traffic Selector | <ul style="list-style-type: none"> • all traffic – Proceed all the packets to the WireGuard tunnel. • subnets – Route based on the subnets listed below. |
| Remote Subnets | If the <i>Traffic Selector</i> is set to <i>subnets</i> , then other subnets (routes) can be routed through the wire tunnel. |
| Pre-shared Key | The optional key for additional encryption layer and security strengthening. You can use the <i>Generate</i> button to generate a random key. |
| Local Private Key | The private key of the local side. You can use the <i>Generate</i> button to generate a random key. |
| Local Public Key | The public key of the local tunnel side. |
| Remote Public Key | The public key of the remote tunnel side. |

Table 37: WireGuard Tunnel Configuration

The changes in settings will apply after clicking the *Apply* button.

4.11.1 WireGuard IPv4 Tunnel Configuration Example

There is an example of WireGuard IPv4 tunnel configuration between *Router A* and *Router B*.

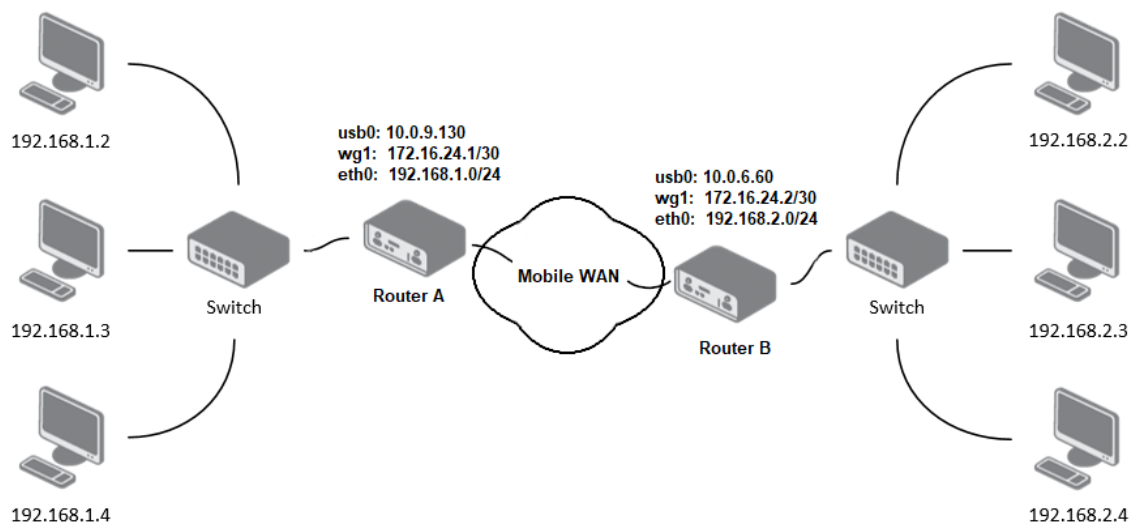

Figure 41: Topology of WireGuard Configuration Example

Router B is configured to listen, and *Router A* is the side initiating the tunnel connection. Configuration of *Router A* and *Router B* from the topology above is as follows:

| Configuration | Router A | Router B |
|------------------------------|--|--|
| Host IP Mode | IPv4 | IPv4 |
| Remote IP Address | 10.0.6.60 | – |
| Remote Port | 51820 | – |
| Local Port | 51820 | 51820 |
| NAT/Firewall Traversal | yes | no |
| Interface IPv4 Address | 172.16.24.1 | 172.16.24.2 |
| Interface IPv4 Prefix Length | 30 | 30 |
| Install Routes | yes | yes |
| Traffic Selector | subnets | subnets |
| Remote Subnets | 192.168.2.0/24 | 192.168.1.0/24 |
| Local Private Key | <i>a local private key</i> | <i>a local private key</i> |
| Local Public Key | <i>a local public key</i> | <i>a local public key</i> |
| Remote Public Key | <i>a public key of the opposite side</i> | <i>a public key of the opposite side</i> |

Table 38: WireGuard IPv4 Tunnel Configuration Example

In the figure below is the WireGuard status page of *Router A*. If the tunnel connection is established successfully, the *Latest handshake* time is shown here. This value is the time left from the latest successful communication with the opposite tunnel side. This item will not be shown here until there is a tunnel communication (data sent by the *Router A* or the keepalive data sent when *NAT/Firewall Traversal* is set to *yes*).

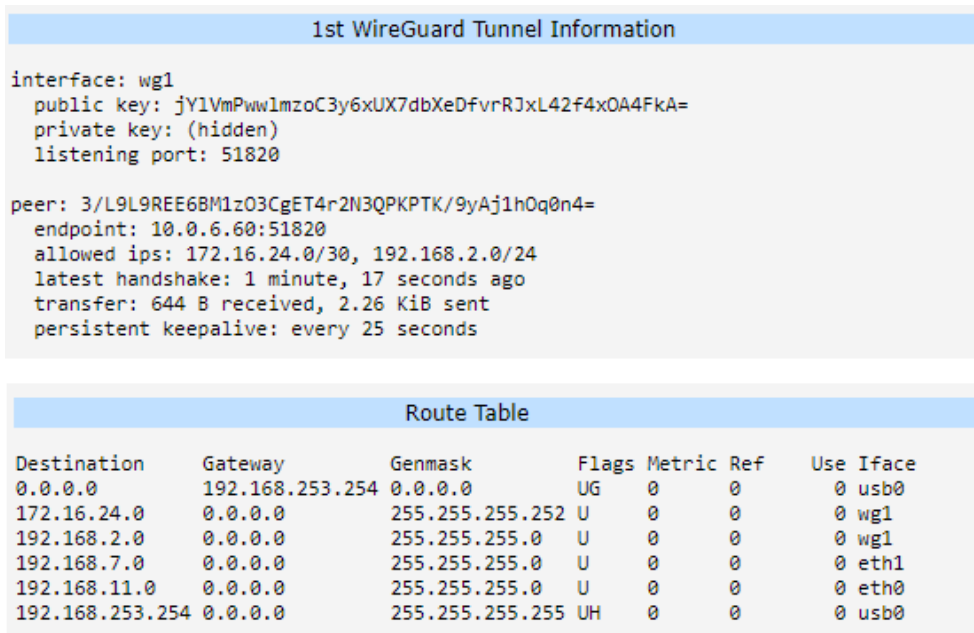

Figure 42: Router A – WireGuard Status Page and Route Table

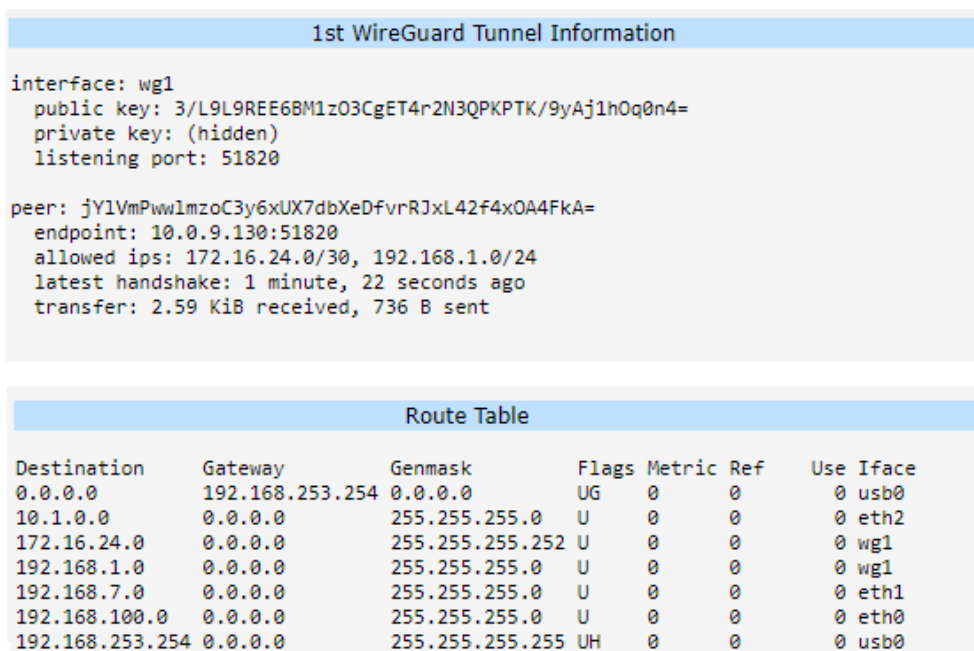

Figure 43: Router B – WireGuard Status Page and Route Table

4.12 GRE Tunnels Configuration



GRE is an unencrypted protocol. GRE via IPv6 is not supported.

To open the *GRE Tunnel Configuration* page, click *GRE* in the *Configuration* section of the main menu. The menu item will expand and you will see four separate configuration pages: *1st Tunnel*, *2nd Tunnel*, *3rd Tunnel* and *4th Tunnel*. The GRE tunnel function allows you to create an unencrypted connection between two separate LAN networks. The router allows you to create four GRE tunnels.

| Item | Description |
|-----------------------------|--|
| Description | Description of the GRE tunnel. |
| Remote IP Address | IP address of the remote side of the tunnel. |
| Local IP Address | IP address of the local side of the tunnel. |
| Remote Subnet | IP address of the network behind the remote side of the tunnel. |
| Remote Subnet Mask | Specifies the mask of the network behind the remote side of the tunnel. |
| Local Interface IP Address | IP address of the local side of the tunnel. |
| Remote Interface IP Address | IP address of the remote side of the tunnel. |
| Multicasts | Activates/deactivates sending multicast into the GRE tunnel: <ul style="list-style-type: none"> • disabled – Sending multicast into the tunnel is inactive. • enabled – Sending multicast into the tunnel is active. |
| Pre-shared Key | Specifies an optional value for the 32 bit shared key in numeric format, with this key the router sends the filtered data through the tunnel. Specify the same key on both routers, otherwise the router drops received packets. |

Table 39: GRE Tunnel Configuration



The GRE tunnel cannot pass through the NAT.

The changes in settings will apply after pressing the *Apply* button.

1st GRE Tunnel Configuration

Create 1st GRE tunnel

Description *

Remote IP Address *

Local IP Address *

Remote Subnet *

Remote Subnet Mask *

Local Interface IP Address *

Remote Interface IP Address *

Multicasts

Pre-shared Key *

** can be blank*

Figure 44: GRE Tunnel Configuration

4.12.1 Example of the GRE Tunnel Configuration

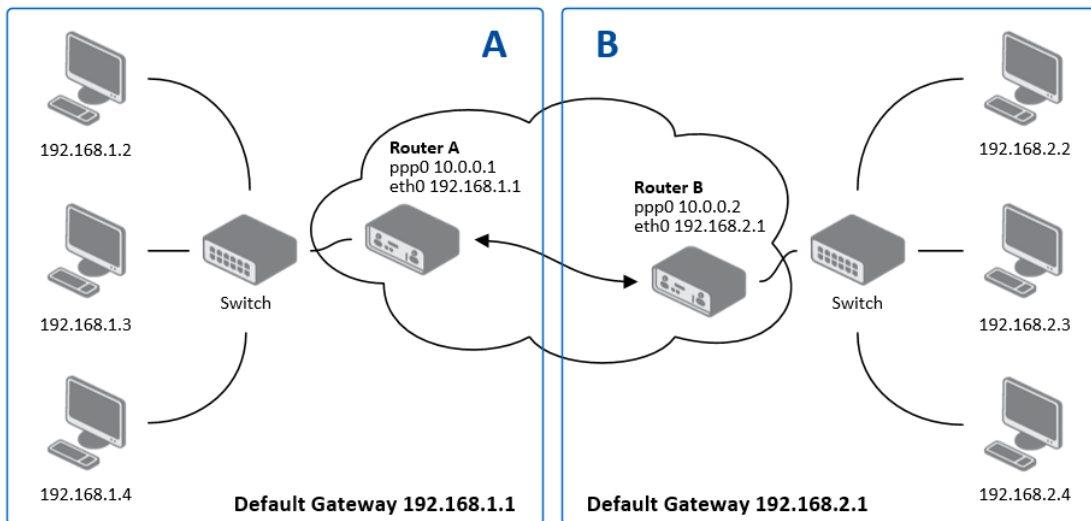

Figure 45: Topology of GRE Tunnel Configuration Example

GRE tunnel configuration:

| Configuration | A | B |
|--------------------|---------------|---------------|
| Remote IP Address | 10.0.0.2 | 10.0.0.1 |
| Remote Subnet | 192.168.2.0 | 192.168.1.0 |
| Remote Subnet Mask | 255.255.255.0 | 255.255.255.0 |

Table 40: GRE Tunnel Configuration Example



Examples of different options for configuration of GRE tunnel can be found in the application note *GRE Tunnel* [6].

4.13 L2TP Tunnel Configuration



L2TP is an unencrypted protocol. L2TP via IPv6 is not supported.

To open the *L2TP Tunnel Configuration* page, click *L2TP* in the *Configuration* section of the main menu. The L2TP tunnel function allows you to create a password-protected connection between two different LAN networks. Enable the *Create L2TP tunnel* checkbox to activate the tunnel.

L2TP Tunnel Configuration

Create L2TP tunnel

Mode ▼

Server IP Address

Client Start IP Address

Client End IP Address

Local IP Address *

Remote IP Address *

Remote Subnet *

Remote Subnet Mask *

MRU bytes

MTU bytes

Username

Password

* can be blank

Figure 46: L2TP Tunnel Configuration

| Item | Description |
|-------------------------|--|
| Mode | Specifies the L2TP tunnel mode on the router side: <ul style="list-style-type: none"> L2TP server – Specify an IP address range offered by the server. L2TP client – Specify the IP address of the server. |
| Server IP Address | IP address of the server. |
| Client Start IP Address | IP address to start with in the address range. The range is offered by the server to the clients. |

Continued on next page

Continued from previous page

| Item | Description |
|-----------------------|--|
| Client End IP Address | The last IP address in the address range. The range is offered by the server to the clients. |
| Local IP Address | IP address of the local side of the tunnel. |
| Remote IP Address | IP address of the remote side of the tunnel. |
| Remote Subnet | Address of the network behind the remote side of the tunnel. |
| Remote Subnet Mask | The mask of the network behind the remote side of the tunnel. |
| MRU | Maximum Receive Unit value. Default value is 1400 bytes. |
| MTU | Maximum Transmission Unit value. Default value is 1400 bytes. |
| Username | Username for the L2TP tunnel login. |
| Password | Password for the L2TP tunnel login. Enter valid characters only. |

Table 41: L2TP Tunnel Configuration

4.13.1 Example of the L2TP Tunnel Configuration

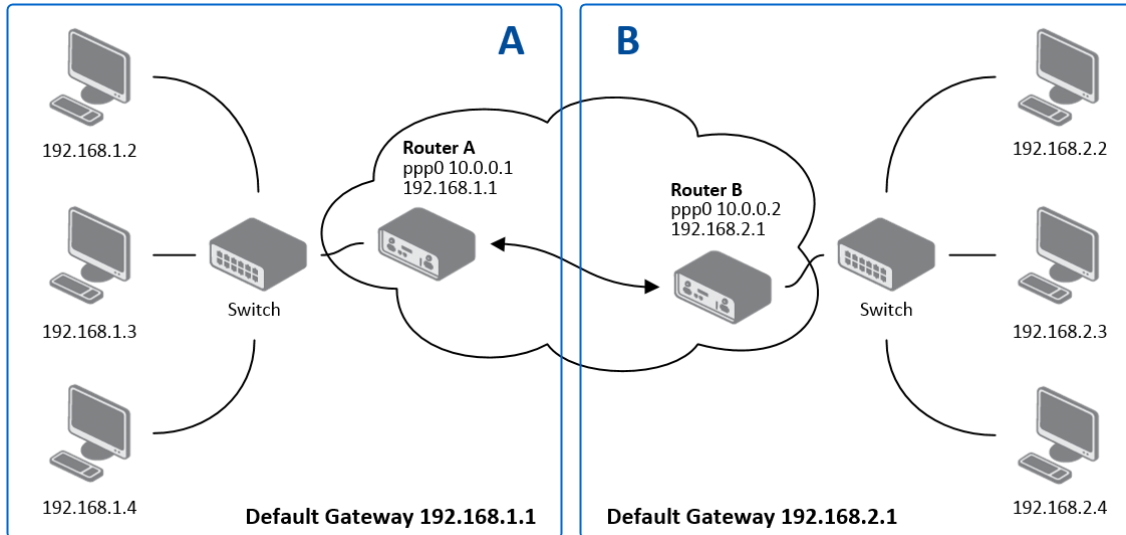

Figure 47: Topology of L2TP Tunnel Configuration Example

Configuration of the L2TP tunnel:

| Configuration | A | B |
|-------------------------|---------------|---------------|
| Mode | L2TP Server | L2TP Client |
| Server IP Address | — | 10.0.0.1 |
| Client Start IP Address | 192.168.2.5 | — |
| Client End IP Address | 192.168.2.254 | — |
| Local IP Address | 192.168.1.1 | — |
| Remote IP Address | — | — |
| Remote Subnet | 192.168.2.0 | 192.168.1.0 |
| Remote Subnet Mask | 255.255.255.0 | 255.255.255.0 |
| Username | username | username |
| Password | password | password |

Table 42: L2TP Tunnel Configuration Example

4.14 PPTP Tunnel Configuration



PPTP is an unencrypted protocol. PPTP via IPv6 is not supported.

Select the *PPTP* item in the menu to configure a PPTP tunnel. PPTP tunnel allows password-protected connections between two LANs. It is similar to L2TP. The tunnels are active after selecting *Create PPTP tunnel*.

PPTP Tunnel Configuration

Create PPTP tunnel

Mode ▼

Server IP Address

Local IP Address

Remote IP Address

Remote Subnet *

Remote Subnet Mask *

MRU bytes

MTU bytes

Username

Password

* can be blank

Figure 48: PPTP Tunnel Configuration

| Item | Description |
|-------------------|--|
| Mode | Specifies the L2TP tunnel mode on the router side: <ul style="list-style-type: none"> ● PPTP server – Specify an IP address range offered by the server. ● PPTP client – Specify the IP address of the server. |
| Server IP Address | IP address of the server. |
| Local IP Address | IP address of the local side of the tunnel. |
| Remote IP Address | IP address of the remote side of the tunnel. |

Continued on next page

Continued from previous page

| Item | Description |
|--------------------|---|
| Remote Subnet | Address of the network behind the remote side of the tunnel. |
| Remote Subnet Mask | The mask of the network behind the remote side of the tunnel |
| MRU | Maximum Receive Unit value. Default value is 1460 bytes to avoid fragmented packets. |
| MTU | Maximum Transmission Unit value. Default value is 1460 bytes to avoid fragmented packets. |
| Username | Username for the PPTP tunnel login. |
| Password | Password for the PPTP tunnel login. Enter valid characters only. |

Table 43: PPTP Tunnel Configuration

The changes in settings will apply after pressing the *Apply* button.



The firmware also supports PPTP passthrough, which means that it is possible to create a tunnel through the router.

4.14.1 Example of the PPTP Tunnel Configuration

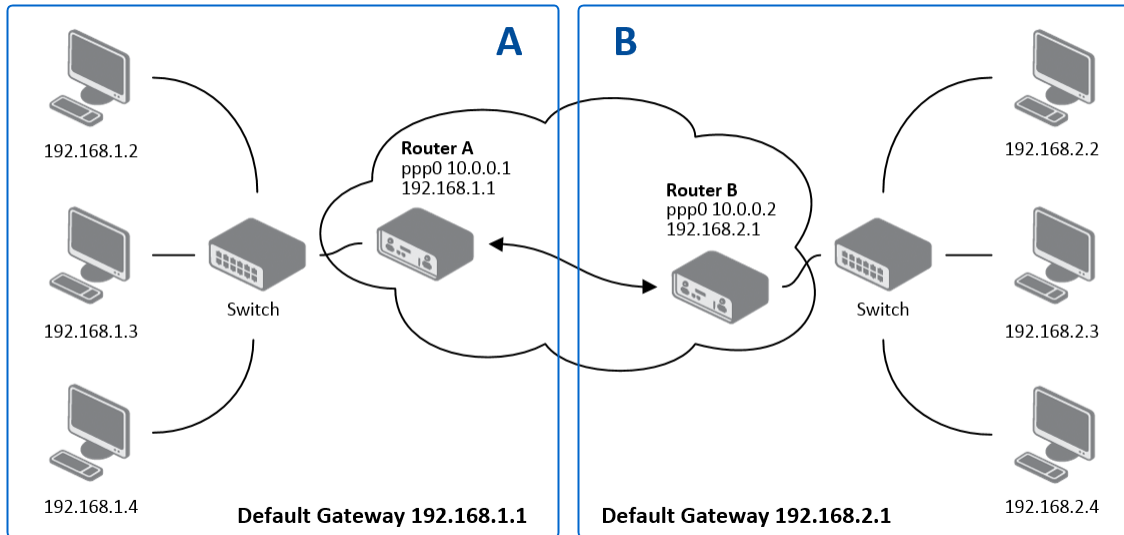

Figure 49: Topology of PPTP Tunnel Configuration Example

Configuration of the PPTP tunnel:

| Configuration | A | B |
|--------------------|---------------|---------------|
| Mode | PPTP Server | PPTP Client |
| Server IP Address | — | 10.0.0.1 |
| Local IP Address | 192.168.1.1 | — |
| Remote IP Address | 192.168.2.1 | — |
| Remote Subnet | 192.168.2.0 | 192.168.1.0 |
| Remote Subnet Mask | 255.255.255.0 | 255.255.255.0 |
| Username | username | username |
| Password | password | password |

Table 44: PPTP Tunnel Configuration Example

4.15 Services

4.15.1 DynDNS

The DynDNS function allows you to access the router remotely using an easy to remember custom hostname. This DynDNS client monitors the IP address of the router and updates the address whenever it changes. In order for DynDNS to function, you require a public IP address, either static or dynamic, and an active Remote Access service account at www.dyndns.org. Register the custom domain (third-level) and account information specified in the configuration form. You can use other services, too – see the table below, Server item. To open the *DynDNS Configuration* page, click *DynDNS* in the main menu.

| Item | Description |
|----------|--|
| Hostname | The third order domain registered on the www.dyndns.org server. |
| Username | Username for logging into the DynDNS server. |
| Password | Password for logging into the DynDNS server. Enter valid characters only, see chap. 2.3! |
| IP Mode | Specifies the version of IP protocol: <ul style="list-style-type: none"> ● IPv4 – IPv4 protocol is used only (default). ● IPv6 – IPv6 protocol is used only. ● IPv4/IPv6 – IPv4 and IPv6 dual stack is enabled. |
| Server | Specifies a DynDNS service other than the www.dyndns.org . Possible other services: www.spdns.de , www.dnsdynamic.org , www.noip.com . Enter the update server service information in this field. If you leave this field blank, the default server members.dyndns.org will be used. |

Table 45: DynDNS Configuration

Example of the DynDNS client configuration with the domain company.dyndns.org:

Figure 50: DynDNS Configuration Example



To access the router’s configuration remotely, you will need to have enabled this option in the NAT configuration (bottom part of the form), see Chapter 4.8.

4.15.2 FTP

FTP protocol (File Transfer Protocol) can be used to transfer files between the router and another device on the computer network. Configuration form of TP server can be done in *FTP* configuration page under *Services* menu item.

| Item | Description |
|--------------------|--|
| Enable FTP service | Enabling of FTP server. |
| Maximum Sessions | Indicates how many concurrent connections shall the FTP server accept. Once the maximum is reached, additional connections will be rejected until some of the existing connections are terminated. The range is from 1 to 500. |
| Session Timeout | Is used to close inactive sessions. The server will terminate a FTP session after it has not been used for the given amount of seconds. The range is from 60 to 7200. |

Table 46: Parameters for FTP service configuration

FTP Configuration

Enable FTP service

| | |
|------------------|--|
| Maximum Sessions | 50 |
| Session Timeout | 600 sec |

Figure 51: Configuration of FTP server

4.15.3 HTTP

HTTP protocol (Hypertext Transfer Protocol) is internet protocol used for exchange of hypertext documents in HTML format. This protocol is used for accessing the web server used for user's configuration of the router. Recommended usage however is of HTTPS protocol, which used encryption for secure exchange of transferred data. Configuration form of HTTP and HTTPS service can be done in *HTTP* configuration page under *Services* menu item. By default, HTTP service is disabled and preferred is using of HTTPS service. For this default setting, a request for communication with HTTP protocol is redirected to HTTPS protocol automatically.

| Item | Description |
|------------------------------|---|
| Enable HTTP service | Enabling of HTTP service. |
| Enable HTTPS service | Enabling of HTTPS service. |
| Minimum TLS Version | If specified, the router will disable TLS versions lower than the specified minimum. For better security choose the highest version of TLS protocol, unless you need to use an older web browser. |
| Session Timeout | Inactivity timeout when the session is closed. |
| Keep the current certificate | Left the current one certificate in the router. |
| Generate a new certificate | Generate a new self-signed certificate to the router. |
| Upload a new certificate | Upload custom PEM certificate, which can be signed by Certificate Authority. |
| Certificate | Choose a file with the PEM certificate. |
| Private Key | Choose a file with the certificate private key. |

Table 47: Parameters for HTTP and HTTPS services configuration

HTTP Configuration

Enable HTTP service
 Enable HTTPS service

Minimum TLS Version TLS 1.0 ▼

Session Timeout 6000 sec

Keep the current certificate
 Generate a new certificate
 Upload a new certificate

Certificate Choose File No file chosen

Private Key Choose File No file chosen

Figure 52: Configuration of HTTP and HTTPS services

4.15.4 NTP

The *NTP* configuration form allows you to configure the NTP client. To open the *NTP* page, click *NTP* in the *Configuration* section of the main menu. NTP (Network Time Protocol) allows you to periodically set the internal clock of the router. The time is set from servers that provide the exact time to network devices. IPv6 Time Servers are supported.

- If you mark the *Enable local NTP service* check box, then the router acts as a NTP server for other devices in the local network (LAN).
- If you mark the *Synchronize clock with NTP server* check box, then the router acts as a NTP client. This means that the router automatically adjusts the internal clock every 24 hours.

| Item | Description |
|------------------------------|--|
| Primary NTP Server Address | IPv4 address, IPv6 address or domain name of primary NTP server. |
| Secondary NTP Server Address | IPv4 address, IPv6 address or domain name of secondary NTP server. |
| Timezone | Specifies the time zone where you installed the router. |
| Daylight Saving Time | Activates/deactivates the DST shift. <ul style="list-style-type: none"> • No – The time shift is inactive. • Yes – The time shift is active. |

Table 48: NTP Configuration

The figure below displays an example of a NTP configuration with the primary server set to *ntp.cesnet.cz* and the secondary server set to *tik.cesnet.cz* and with the automatic change for daylight saving time enabled.

NTP Configuration

Enable local NTP service

Synchronize clock with NTP server

Primary NTP Server

Secondary NTP Server

Timezone ▼

Daylight Saving Time ▼

Figure 53: Example of NTP Configuration

4.15.5 PAM

A pluggable authentication module (PAM) is a mechanism to integrate multiple low-level authentication schemes into a high-level application programming interface (API). The configuration made on this configuration page will affect all the router's authentication mechanisms. As the first option, choose the *PAM Mode*. The modes available and their description are listed in Table 49.

| Item | Description |
|----------|--|
| PAM Mode | <ul style="list-style-type: none"> • local user database – Authenticate against the local user database only, see Chapter 6.1. • RADIUS with fallback – Authenticate against the RADIUS server first and then against the local database in case the RADIUS server is not accessible. • RADIUS only – Authenticate only against the RADIUS server. Note that you will not be able to authenticate to the router in case the RADIUS server is not accessible! • TACACS+ with fallback – Authenticate against the TACACS+ server first and then against the local database in case the TACACS+ server is not accessible. • TACACS+ only – Authenticate only against the TACACS+ server. Note that you will not be able to authenticate to the router in case the TACACS+ server is not accessible! |

Table 49: Available Modes of PAM

To configure the authentication against the local user database, choose local user database and enable the debug mode eventually, see Figure 54.

| PAM Configuration | |
|-------------------|---------------------|
| Mode | local user database |
| Debug | Disabled |
| * can be blank | |
| Apply | |

Figure 54: Configuration of Local User Database



When authenticate against the RADIUS or TACACS+ server, user with the same name must exist locally. It can be created manually (see Chapter 6.1) or can be created automatically based on data from RADIUS/TACACS+ server, if the *Take Over Server Users* option is enabled as described hereunder.

To configure the authentication against a RADIUS server, choose *RADIUS with fallback* or *RADIUS only* as the *PAM mode* and set up all required items, see Figure 55.

| PAM Configuration | | | |
|--------------------------|------------------------|----------------------|--------------------------|
| Mode | RADIUS with fallback ▼ | | |
| RADIUS Server(s) | | | |
| Server | Port * | Secret | Timeout * |
| <input type="checkbox"/> | <input type="text"/> | <input type="text"/> | <input type="text"/> sec |
| <input type="checkbox"/> | <input type="text"/> | <input type="text"/> | <input type="text"/> sec |
| Take Over Server Users | Disabled ▼ | | |
| Default User Role | Admin ▼ | | |
| Debug | Disabled ▼ | | |
| * can be blank | | | |
| Apply | | | |

Figure 55: Configuration of RADIUS

Table 50 describes all the configuration options for the RADIUS PAM modes.

| Item | Description |
|------------------------|---|
| Server | Address of the RADIUS server. Up to two servers can be configured. |
| Port | Port of the RADIUS server. |
| Secret | The secret For authentication to the RADIUS server. |
| Timeout | Timeout for authentication to the RADIUS server. |
| Take Over Server Users | If enabled, a new user account is created during the login, in case the RADIUS authentication is successful and appropriate local account does not exist. New accounts are created without the password. An existing user account with a password is never modified by this feature. |
| Default User Role | Choose the user role (<i>Admin</i> or <i>User</i>). This role corresponds with router's user roles, see Chapter 6.1. Selected role will be used for a user in case the option <i>Take Over Server Users</i> is enabled and if the user's <i>Service-Type</i> set on the RADIUS server is missing or is not set up to <i>NAS-Prompt-User</i> or <i>Administrative-User</i> . When <i>Service-Type</i> is set to <i>NAS-Prompt-User</i> , the <i>User</i> role will be used. When <i>Service-Type</i> is set to <i>Administrative-User</i> , the <i>Admin</i> role will be used. |
| Debug | Enables or disables the logging of the RADIUS debug information into the System Log. |

Table 50: Configuration of RADIUS

To configure the authentication against a TACACS+ server, choose *TACACS+ with fallback* or *TACACS+ only* as the *PAM mode* and set up all required items, see Figure 56.

Figure 56: Configuration of TACACS+

Table 51 describes all the configuration options for the TACACS PAM modes.

| Item | Description |
|------------------------|---|
| Authentication Type | Choose ASCII, PAP or CHAP as authentication type. |
| Timeout | Timeout for authentication to the TACACS+ server. |
| Server | Address of the TACACS+ server. Up to two servers can be configured. |
| Port | Port of the TACACS+ server. |
| Secret | The secret For authentication to the TACACS+ server. |
| Take Over Server Users | If enabled, a new user account is created during the login, in case the TACACS+ authentication is successful and appropriate local account does not exist. New accounts are created without the password. An existing user account with a password is never modified by this feature. |
| Default User Role | Choose the user role (<i>Admin</i> or <i>User</i>). This role corresponds with router's user roles, see Chapter 6.1. Selected role will be used for a new user when <i>Take Over Server Users</i> item is enabled. |
| Debug | Enables or disables the logging of the TACACS+ debug information into the System Log. |

Table 51: Configuration of TACACS+

4.15.6 SNMP

The *SNMP* page allows you to configure the SNMP v1/v2 or v3 agent which sends information about the router (and about its expansion ports eventually) to a management station. To open the *SNMP* page, click *SNMP* in the *Configuration* section of the main menu. SNMP (Simple Network Management Protocol) provides status information about the network elements such as routers or endpoint computers. In the version v3, the communication is secured (encrypted). To enable the SNMP service, mark the *Enable the SNMP agent* check box. Sending SNMP traps to IPv6 address is supported.

| Item | Description |
|----------|---|
| Name | Designation of the router. |
| Location | Location of where you installed the router. |
| Contact | Person who manages the router together with information how to contact this person. |

Table 52: SNMP Agent Configuration

To enable the SNMPv1/v2 function, mark the *Enable SNMPv1/v2 access* check box. It is also necessary to specify a password for access to the *Community* SNMP agent. The default setting is *public*.

You can define a different password for the *Read* community (read only) and the *Write* community (read and write) for SNMPv1/v2. You can also define 2 SNMP users for SNMPv3. You can define a user as read only (*Read*), and another as read and write (*Write*). The router allows you to configure the parameters in the following table for every user separately. The router uses the parameters for SNMP access only.

To enable the SNMPv3 function, mark the *Enable SNMPv3 access* check box, then specify the following parameters:

| Item | Description |
|-------------------------|--|
| Username | User name |
| Authentication | Encryption algorithm on the Authentication Protocol that is used to verify the identity of the users. |
| Authentication Password | Password used to generate the key used for authentication. Enter valid characters only, see chap. 2.3! |
| Privacy | Encryption algorithm on the Privacy Protocol that is used to ensure confidentiality of data. |
| Privacy Password | Password for encryption on the Privacy Protocol. Enter valid characters only, see chap. 2.3! |

Table 53: SNMPv3 Configuration

Activating the *Enable I/O extension* function allows you monitor the binary I/O inputs on the router.



Selecting *Enable M-BUS extension* and entering the *Baudrate*, *Parity* and *Stop Bits* lets you monitor the meter status connected via MBUS interface. MBUS expansion port is not currently supported, but it is possible to use an external RS232/MBUS converter.

Selecting *Enable reporting to supervisory system* and entering the *IP Address* and *Period* lets you send statistical information to the monitoring system, R-SeeNet.

| Item | Description |
|------------|---|
| IP Address | IPv4 or IPv6 address. |
| Period | Period of sending statistical information (in minutes). |

Table 54: SNMP Configuration (R-SeeNet)

Each monitored value is uniquely identified using a numerical identifier *OID – Object Identifier*. This identifier consists of a progression of numbers separated by a point. The shape of each OID is determined by the identifier value of the parent element and then this value is complemented by a point and current number. So it is obvious that there is a tree structure. The following figure displays the basic tree structure that is used for creating the OIDs.

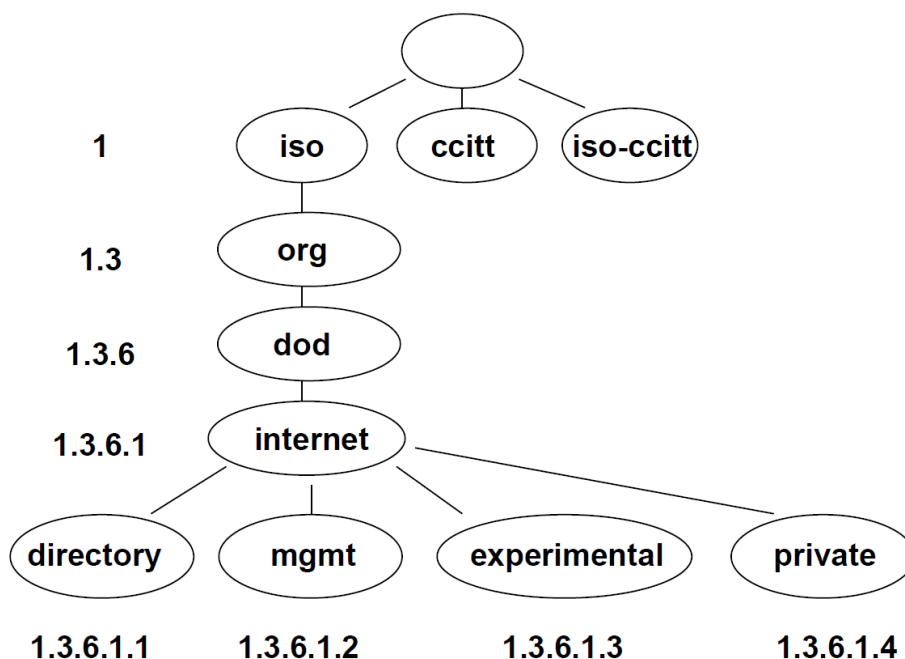

Figure 57: OID Basic Structure

The SNMP values that are specific for Advantech routers create the tree starting at $OID = .1.3.6.1.4.1.30140$. You interpret the OID in the following manner:

iso.org.dod.internet.private.enterprises.conel

For binary inputs and output, the following range of OID is used:

| OID | Description |
|----------------------------|---------------------------------|
| .1.3.6.1.4.1.30140.2.3.1.0 | Binary input BIN0 (values 0,1) |
| .1.3.6.1.4.1.30140.2.3.2.0 | Binary output OUT0 (values 0,1) |
| .1.3.6.1.4.1.30140.2.3.3.0 | Binary input BIN1 (values 0,1) |

Table 55: Object identifier for binary inputs and output



The list of available and supported OIDs and other details can be found in the application note *SNMP Object Identifiers* [8].

SNMP Configuration

Enable SNMP agent

Name *

Location *

Contact *

(Configuration via SNMP is not possible.)

Enable SNMPv1/v2 access

| | | |
|-----------|-------------------------------------|--------------------------------------|
| | Read | Write |
| Community | <input type="text" value="public"/> | <input type="text" value="private"/> |

Enable SNMPv3 access

| | | |
|-------------------------|----------------------------------|----------------------------------|
| | Read | Write |
| Username | <input type="text"/> | <input type="text"/> |
| Authentication | <input type="text" value="MD5"/> | <input type="text" value="MD5"/> |
| Authentication Password | <input type="text"/> | <input type="text"/> |
| Privacy | <input type="text" value="DES"/> | <input type="text" value="DES"/> |
| Privacy Password | <input type="text"/> | <input type="text"/> |

Enable I/O extension

Enable XC-CNT extension

Enable M-BUS extension

| | | |
|-----------|-----------------------------------|--|
| Baudrate | <input type="text" value="300"/> | |
| Parity | <input type="text" value="even"/> | |
| Stop Bits | <input type="text" value="1"/> | |

Enable reporting to supervisory system

IP Address

Period min

* can be blank

Figure 58: SNMP Configuration Example

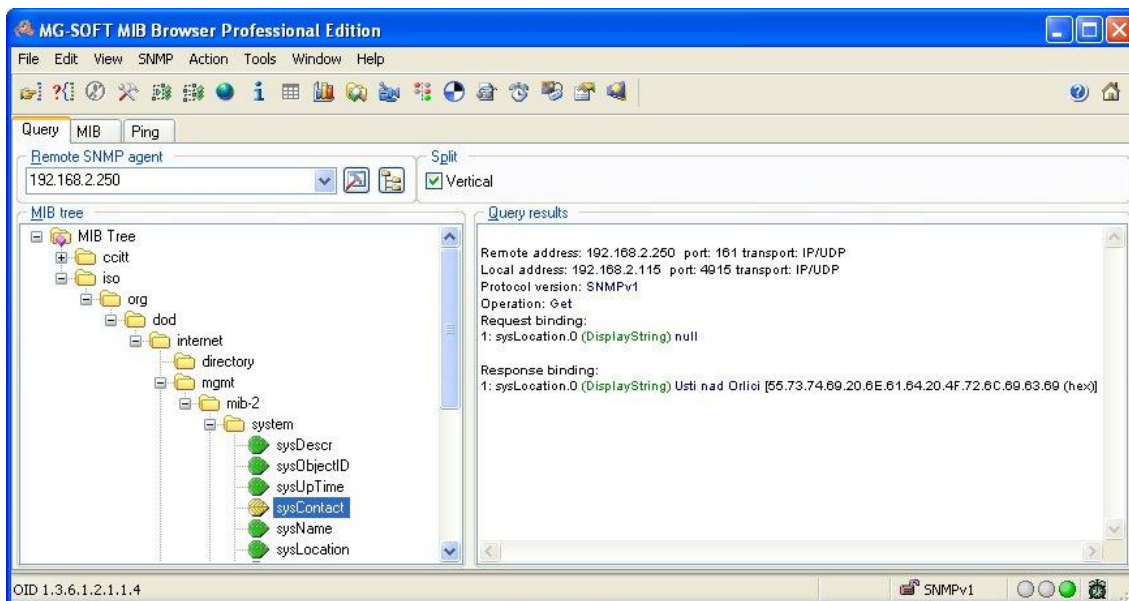

Figure 59: MIB Browser Example

In order to access a particular device enter the IP address of the SNMP agent which is the router, in the *Remote SNMP agent* field. The dialog displayed the internal variables in the MIB tree after entering the IP address. Furthermore, you can find the status of the internal variables by entering their OID.

The path to the objects is:

iso → org → dod → internet → private → enterprises → Conel → protocols

The path to information about the router is:

iso → org → dod → internet → mgmt → mib-2 → system

4.15.7 SMTP

Use the *SMTP* form to configure the Simple Mail Transfer Protocol client (SMTP) for sending e-mails. IPv6 e-mail servers are supported.

| Item | Description |
|---------------------|---|
| SMTP Server Address | IPv4 address, IPv6 address or domain name of the mail server. |
| SMTP Port | Port the SMTP server is listening on. |
| Secure Method | none, SSL/TLS, or STARTTLS. Secure method has to be supported by the SMTP server. |
| Username | Name for the e-mail account. |
| Password | Password for the e-mail account. Enter valid characters only, see chap. 2.3! |
| Own E-mail Address | Address of the sender. |

Table 56: SMTP client configuration



The mobile service provider can block other SMTP servers, then you can only use the SMTP server of the service provider.

SMTP Configuration

| | |
|--------------------------------------|---|
| SMTP Server Address | <input type="text" value="smtp.domain.com"/> |
| SMTP Port | <input type="text" value="465"/> |
| Secure Method | <input style="border-bottom: 1px solid #ccc;" type="text" value="SSL/TLS"/> |
| Username | <input type="text" value="username"/> |
| Password | <input type="password" value="*****"/> |
| Own Email Address | <input type="text" value="name@domain.com"/> |
| <input type="button" value="Apply"/> | |

Figure 60: SMTP Client Configuration Example

You can send e-mails from the Startup script. The *Startup Script* dialog is located in *Scripts* in the *Configuration* section of the main menu. The router also allows you to send e-mails using an SSH connection. Use the email command with the following parameters:

- t e-mail address of the receiver
- s subject, enter the subject in quotation marks
- m message, enter the subject in quotation marks
- a attachment file
- r number of attempts to send e-mail (default setting: 2)



Commands and parameters can be entered only in lowercase.

Example of sending an e-mail:



```
email -t john@doe.com -s "System Log" -m "Attached" -a /var/log/messages
```

The command above sends an e-mail to address *john@doe.com* with the subject "*System Log*", body message "*Attached*" and attachment *messages* file with *System Log* of the router directly from the directory */var/log/*.

4.15.8 SMS

Open the *SMS* page in the *Services* submenu of the *Configuration* section of the main menu. The router can automatically send SMS messages to a cell phone or SMS message server when certain events occur. The format allows you to select which events generate an SMS message.

| Item | Description |
|---|--|
| Send SMS on power up | Activates/deactivates the sending of an SMS message automatically on power up. |
| Send SMS on connect to mobile network | Activates/deactivates the sending of an SMS message automatically when the router is connected to a mobile network. |
| Send SMS on disconnect to mobile network | Activates/deactivates the sending of an SMS message automatically when the router is disconnection from a mobile network. |
| Send SMS when datalimit exceeded | Activates/deactivates the sending of an SMS message automatically when the data limit exceeded. |
| Send SMS when binary input on I/O port (BIN0) is active | Automatic sending SMS message after binary input on I/O port (BIN0) is active. Text of message is intended parameter BIN0. |
| Add timestamp to SMS | Activates/deactivates the adding a time stamp to the SMS messages. This time stamp has a fixed format YYYY-MM-DD hh:mm:ss. |
| Phone Number 1 | Specifies the phone number to which the router sends the generated SMS. |
| Phone Number 2 | Specifies the phone number to which the router sends the generated SMS. |
| Phone Number 3 | Specifies the phone number to which the router sends the generated SMS. |
| Unit ID | The name of the router. The router sends the name in the SMS. |
| BIN0 – SMS | Text of the SMS message when the first binary input is activated. |

Table 57: SMS Configuration

Remote Control via SMS

After you enter a phone number in the *Phone Number 1* field, the router allows you to configure the control of the device using an SMS message. You can configure up to three numbers for incoming SMS messages. To enable the function, mark the *Enable remote control via SMS* check box. The default setting of the remote control function is active.

| Item | Description |
|----------------|--|
| Phone Number 1 | Specifies the first phone number allowed to access the router using an SMS. |
| Phone Number 2 | Specifies the second phone number allowed to access the router using an SMS. |
| Phone Number 3 | Specifies the third phone number allowed to access the router using an SMS. |

Table 58: Control via SMS



If you enter one or more phone numbers, then you can control the router using SMS messages sent only from the specified phone numbers.
 If you enter the wild card character *, then you can control the router using SMS messages sent from any phone number.

Most of the control SMS messages do not change the router configuration. For example, if the router is changed to the off line mode using an SMS message, the router remains in this mode, but it will return back to the on-line mode after reboot. The only exception is *set profile* command that changes the configuration permanently, see the table below.

To control the router using an SMS, send only message text containing the control command. You can send control SMS messages in the following format:

| SMS | Description |
|------------------|---|
| go online sim 1 | Switch the mobile WAN to the SIM1. |
| go online sim 2 | Switch the mobile WAN to the SIM2. Models with one SIM slot will switch the settings for inserted SIM to the settings configured for the 2nd SIM. |
| go online | Switch the router to the online mode. |
| go offline | Switch the router to the off line mode. |
| set out0=0 | Set the binary output to 0. |
| set out0=1 | Set the binary output to 1. |
| set profile std | Set the standard profile. This change is permanent. |
| set profile alt1 | Set the alternative profile 1. This change is permanent. |
| set profile alt2 | Set the alternative profile 2. This change is permanent. |

Continued on next page

Continued from previous page

| SMS | Description |
|------------------|--|
| set profile alt3 | Set the alternative profile 3. This change is permanent. |
| reboot | Reboot the router. |
| get ip | Respond with the IP address of the SIM card. |

Table 59: Control SMS



Note: Every received control SMS is processed and then **deleted** from the router! This may cause a confusion when you want to use AT-SMS protocol for reading received SMS (see section below).



Advanced SMS control: If there is unknown command in received SMS and remote control via SMS is enabled, the script located in "/var/scripts/sms" is run before the SMS is deleted. It is possible to define your own additional SMS commands using this script. Maximum of 7 words can be used in such SMS. Since the script file is located in RAM of the router, it is possible to add creation of such file to Startup Script. See example in *Commands and Scripts* Application Note [1].

AT-SMS Protocol



AT-SMS protocol is a private set of AT commands supported by the routers. It can be used to access the cellular module in the router directly via commonly used AT commands, work with short messages (send SMS) and cellular module state information and settings.

Choosing *Enable AT-SMS protocol on expansion port 1* and *Baudrate* makes it possible to use AT-SMS protocol on the serial Port 1.

| Item | Description |
|----------|---|
| Baudrate | Communication speed on the expansion port 1 |

Table 60: Send SMS on the serial Port 1

Choosing *Enable AT-SMS protocol on expansion port 2* and *Baudrate* makes it possible to use AT-SMS protocol on the serial Port 2.

| Item | Description |
|----------|---|
| Baudrate | Communication speed on the expansion port 2 |

Table 61: Send SMS on the serial Port 2

Setting the parameters in the *Enable AT-SMS protocol over TCP* frame, you can enable the router to use AT-SMS protocol on a TCP port. This function requires you to specify a TCP port number.

| Item | Description |
|----------|---|
| TCP Port | TCP port on which will be allowed to send/receive SMS messages. |

Table 62: Sending/receiving of SMS on TCP port specified

If you establish a connection to the router through a serial interface or interface using the TCP protocol, then you can use AT commands to manage SMS messages.

Only the commands supported by the routers are listed in the following table. For other AT commands the OK response is always sent. There is no support for treatment of complex AT commands, so in such a case the router sends ERROR response.

| AT Command | Description |
|------------|---|
| AT+CGMI | Returns the manufacturer specific identity |
| AT+CGMM | Returns the manufacturer specific model identity |
| AT+CGMR | Returns the manufacturer specific model revision identity |
| AT+CGPADDR | Displays the IP address of the Mobile WAN interface |
| AT+CGSN | Returns the product serial number |
| AT+CIMI | Returns the International Mobile Subscriber Identity number (IMSI) |
| AT+CMGD | Deletes a message from the location |
| AT+CMGF | Sets the presentation format of short messages |
| AT+CMGL | Lists messages of a certain status from a message storage area |
| AT+CMGR | Reads a message from a message storage area |
| AT+CMGS | Sends a short message from the device to entered tel. number |
| AT+CMGW | Writes a short message to SIM storage |
| AT+CMSS | Sends a message from SIM storage location value |
| AT+CNUM | Returns the phone number, if available (stored on SIM card) |
| AT+COPS? | Identifies the available mobile networks |
| AT+CPIN | Is used to find out the SIM card state and enter a PIN code |
| AT+CPMS | Selects SMS memory storage types, to be used for short message operations |
| AT+CREG | Displays network registration status |
| AT+CSCA | Sets the short message service centre (SMSC) number |
| AT+CSCS | Selects the character set |

Continued on next page

Continued from previous page

| AT Command | Description |
|------------|--|
| AT+CSQ | Returns the signal strength of the registered network |
| AT+GMI | Returns the manufacturer specific identity |
| AT+GMM | Returns the manufacturer specific model identity |
| AT+GMR | Returns the manufacturer specific model revision identity |
| AT+GSN | Returns the product serial number |
| ATE | Determines whether or not the device echoes characters |
| ATI | Transmits the manufacturer specific information about the device |

Table 63: List of AT Commands



A detailed description and examples of these AT commands can be found in the application note *AT Commands (AT-SMS)* [9].

Sending SMS from Router

There are more ways how to send your own SMS from the router:

- Using AT-SMS protocol described above – if you establish a connection to the router through a serial interface or interface using the TCP protocol, then you can use AT commands to manage SMS messages. See application note *AT Commands (AT-SMS)* [9].
- Using HTTP POST method for a remote execution, calling CGI scripts in the router. See *Commands and Scripts Application Note* [1] for more details and example.
- From Web interface of the router, in *Administration* section, *Send SMS* item, see Chapter 6.8.
- Using `gsmsms` command e.g. in terminal when connected to the router via SSH. See *Commands and Scripts Application Note* [1].

Examples of SMS Configuration

Example 1 Sending SMS Configuration

After powering up the router, the phone with the number entered in the dialog receives an SMS in the following format:

Router (Unit ID) has been powered up. Signal strength -xx dBm.

After connecting to mobile network, the phone with the number entered in the dialog receives an SMS in the following format:

Router (Unit ID) has established connection to mobile network. IP address xxx.xxx.xxx.xxx

After disconnecting from the mobile network, the phone with the number entered in the dialog receives an SMS in the following format:

Router (Unit ID) has lost connection to mobile network. IP address xxx.xxx.xxx.xxx

| SMS Configuration | |
|--------------------------------------|--|
| <input checked="" type="checkbox"/> | Send SMS on power up |
| <input checked="" type="checkbox"/> | Send SMS on connect to mobile network |
| <input checked="" type="checkbox"/> | Send SMS on disconnect from mobile network |
| <input checked="" type="checkbox"/> | Send SMS when datalimit is exceeded |
| <input checked="" type="checkbox"/> | Send SMS when binary input on I/O port (BIN0) is active |
| <input checked="" type="checkbox"/> | Send SMS when binary input on expansion port 1 (BIN1-BIN4) is active |
| <input checked="" type="checkbox"/> | Add timestamp to SMS |
| Phone Number 1 | <input type="text" value="723123456"/> |
| Phone Number 2 | <input type="text" value="756858635"/> |
| Phone Number 3 | <input type="text" value="603854758"/> |
| Unit ID * | <input type="text" value="Router"/> |
| BIN0 - SMS * | <input type="text" value="BIN0"/> |
| <input checked="" type="checkbox"/> | Enable remote control via SMS |
| Phone Number 1 | <input type="text"/> |
| Phone Number 2 | <input type="text"/> |
| Phone Number 3 | <input type="text"/> |
| <input type="checkbox"/> | Enable AT-SMS protocol on expansion port 1 |
| Baudrate | <input type="text" value="9600"/> |
| <input type="checkbox"/> | Enable AT-SMS protocol on expansion port 2 |
| Baudrate | <input type="text" value="9600"/> |
| <input type="checkbox"/> | Enable AT-SMS protocol over TCP |
| TCP Port | <input type="text"/> |
| * can be blank | |
| <input type="button" value="Apply"/> | |

Figure 61: SMS Configuration for Example 1

Example 2 Sending SMS via Serial Interface on the Port 1

| SMS Configuration | |
|--|----------------------|
| <input type="checkbox"/> Send SMS on power up <input type="checkbox"/> Send SMS on connect to mobile network <input type="checkbox"/> Send SMS on disconnect from mobile network <input type="checkbox"/> Send SMS when datalimit is exceeded <input type="checkbox"/> Send SMS when binary input on I/O port (BIN0) is active <input type="checkbox"/> Send SMS when binary input on expansion port 1 (BIN1-BIN4) is active <input type="checkbox"/> Add timestamp to SMS | |
| Phone Number 1 | <input type="text"/> |
| Phone Number 2 | <input type="text"/> |
| Phone Number 3 | <input type="text"/> |
| Unit ID * | <input type="text"/> |
| BIN0 - SMS * | <input type="text"/> |
| <input type="checkbox"/> Enable remote control via SMS | |
| Phone Number 1 | <input type="text"/> |
| Phone Number 2 | <input type="text"/> |
| Phone Number 3 | <input type="text"/> |
| <input checked="" type="checkbox"/> Enable AT-SMS protocol on expansion port 1 Baudrate <input type="text" value="9600"/> ▼ | |
| <input type="checkbox"/> Enable AT-SMS protocol on expansion port 2 Baudrate <input type="text" value="9600"/> ▼ | |
| <input type="checkbox"/> Enable AT-SMS protocol over TCP TCP Port <input type="text"/> | |
| * can be blank | |
| <input type="button" value="Apply"/> | |

Figure 62: SMS Configuration for Example 2

Example 3 Control the Router Sending SMS from any Phone Number

| SMS Configuration | |
|---|--------------------------------|
| <input type="checkbox"/> Send SMS on power up <input type="checkbox"/> Send SMS on connect to mobile network <input type="checkbox"/> Send SMS on disconnect from mobile network <input type="checkbox"/> Send SMS when datalimit is exceeded <input type="checkbox"/> Send SMS when binary input on I/O port (BIN0) is active <input type="checkbox"/> Add timestamp to SMS | |
| Phone Number 1 | <input type="text"/> |
| Phone Number 2 | <input type="text"/> |
| Phone Number 3 | <input type="text"/> |
| Unit ID * | <input type="text"/> |
| BINO - SMS * | <input type="text"/> |
| <input checked="" type="checkbox"/> Enable remote control via SMS | |
| Phone Number 1 | <input type="text" value="*"/> |
| Phone Number 2 | <input type="text"/> |
| Phone Number 3 | <input type="text"/> |
| <input type="checkbox"/> Enable AT-SMS protocol on expansion port 1 Baudrate <input type="text" value="9600"/> | |
| <input type="checkbox"/> Enable AT-SMS protocol on expansion port 2 Baudrate <input type="text" value="9600"/> | |
| <input type="checkbox"/> Enable AT-SMS protocol over TCP TCP Port <input type="text"/> * can be blank | |
| <input type="button" value="Apply"/> | |

Figure 63: SMS Configuration for Example 3

Example 4 Control the Router Sending SMS from Two Phone Numbers

| SMS Configuration | |
|--------------------------------------|--|
| <input type="checkbox"/> | Send SMS on power up |
| <input type="checkbox"/> | Send SMS on connect to mobile network |
| <input type="checkbox"/> | Send SMS on disconnect from mobile network |
| <input type="checkbox"/> | Send SMS when datalimit is exceeded |
| <input type="checkbox"/> | Send SMS when binary input on I/O port (BIN0) is active |
| <input type="checkbox"/> | Send SMS when binary input on expansion port 1 (BIN1-BIN4) is active |
| <input type="checkbox"/> | Add timestamp to SMS |
| <input type="checkbox"/> | Enable remote control via SMS |
| Phone Number 1 | <input type="text"/> |
| Phone Number 2 | <input type="text"/> |
| Phone Number 3 | <input type="text"/> |
| Unit ID * | <input type="text"/> |
| BIN0 - SMS * | <input type="text"/> |
| <input checked="" type="checkbox"/> | Enable remote control via SMS |
| Phone Number 1 | <input type="text" value="728123456"/> |
| Phone Number 2 | <input type="text" value="766254864"/> |
| Phone Number 3 | <input type="text"/> |
| <input type="checkbox"/> | Enable AT-SMS protocol on expansion port 1 |
| Baudrate | <input type="text" value="9600"/> |
| <input type="checkbox"/> | Enable AT-SMS protocol on expansion port 2 |
| Baudrate | <input type="text" value="9600"/> |
| <input type="checkbox"/> | Enable AT-SMS protocol over TCP |
| TCP Port | <input type="text"/> |
| * can be blank | |
| <input type="button" value="Apply"/> | |

Figure 64: SMS Configuration for Example 4

4.15.9 SSH

SSH protocol (Secure Shell) allows to carry out a secure remote login to the router. Configuration form of SSH service can be done in *SSH* configuration page under *Services* menu item. By ticking *Enable SSH service* item the SSH server on the router is enabled.

| Item | Description |
|--------------------|--|
| Enable SSH service | Enabling of SSH service. |
| Session Timeout | Inactivity timeout when the session is closed. |

Table 64: Parameters for SSH service configuration

SSH Configuration

Enable SSH service

Session Timeout sec

Figure 65: Configuration of HTTP service

4.15.10 Syslog

Configuration of system log, called syslog, can be done on this configuration page. Size of this log can be restricted by maximal number of its rows. Optionally, the IP address and UDP port can be configured for the real-time log distribution.

| Položka | Popis |
|-------------------|---|
| Log Size | Log size restriction by maximal number of its rows. |
| Remote IP Address | Optional settings of IP address for real-time log distribution. |
| Remote UDP Port | Optional settings of UDP port for real-time log distribution. |

Table 65: Syslog configuration

| Syslog Configuration | |
|--------------------------------------|---|
| Log Size | <input type="text" value="1000"/> lines |
| Remote IP Address | <input type="text"/> |
| Remote UDP Port | <input type="text" value="514"/> |
| <input type="button" value="Apply"/> | |

Figure 66: Syslog configuration

4.15.11 Telnet

Telnet is a protocol used to provide a bidirectional interactive text-oriented communication facility with the router. Configuration form of Telnet service can be done in *Telnet* configuration page under *Services* menu item.

| Item | Description |
|-----------------------|--|
| Enable Telnet service | Enabling of Telnet service. |
| Maximum Sessions | Is used to close inactive sessions. The server will terminate a Telnet session after it has not been used for the given amount of seconds. The range is from 1 to 500. |

Table 66: Parameters for Telnet service configuration

Telnet Configuration

Enable Telnet service

Maximum Sessions

Figure 67: Configuration of Telnet service

4.16 Expansion Ports – RS232, RS485



Supported by ICR-2431 and ICR-2631 only.

Configuration of the RS232 and RS485 interfaces can be done via *Expansion Port 1* resp. *Expansion Port 2* menu items.

In the upper part of the configuration window, the port can be enabled and the type of the connected port is shown in the *Port Type* item. Other items are described in the table below. IPv6 TCP/UDP client/server are supported.

Expansion Port 1 Configuration

Enable expansion port 1 access over TCP/UDP

Port Type:

Baudrate:

Data Bits:

Parity:

Stop Bits:

Flow Control:

Split Timeout: msec

Protocol:

Mode:

Server Address:

TCP Port:

Inactivity Timeout *: sec

Reject new connections

Check TCP connection

Keepalive Time: sec

Keepalive Interval: sec

Keepalive Probes:

Use CD as indicator of TCP connection

Use DTR as control of TCP connection

* can be blank

Figure 68: Expansion Port Configuration

| Item | Description |
|-----------|------------------------------|
| Baudrate | Applied communication speed. |
| Data Bits | Number of data bits. |

Continued on next page

Continued from previous page

| Item | Description |
|--------------------|---|
| Parity | Control parity bit: <ul style="list-style-type: none"> • none – data will be sent without parity. • even – data will be sent with even parity. • odd – data will be sent with odd parity. |
| Stop Bits | Number of stop bits. |
| Flow Control | Set the flow control to none or hardware . |
| Split Timeout | Time to rupture reports. If the gap between two characters exceeds the parameter in milliseconds, any buffered characters will be sent over the Ethernet port. |
| Protocol | Protocol: <ul style="list-style-type: none"> • TCP – communication using a linked protocol TCP. • UDP – communication using a unlinked protocol UDP. |
| Mode | Mode of connection: <ul style="list-style-type: none"> • TCP server – The router will listen for incoming TCP connection requests. • TCP client – The router will connect to a TCP server on the specified IP address and TCP port. |
| Server Address | When set to <i>TCP client</i> above, it is necessary to enter the <i>Server address</i> and <i>TCP port</i> . IPv4 and IPv6 addresses are allowed. |
| TCP Port | TCP/UDP port used for communications. The router uses the value for both the server and client modes. |
| Inactivity Timeout | Time period after which the TCP/UDP connection is interrupted in case of inactivity. |

Table 67: Expansion Port Configuration – serial interface

If you mark the *Reject new connections* check box, then the router rejects any other connection attempt. This means that the router no longer supports multiple connections.

If you mark the *Check TCP connection* check box, the router verifies the TCP connection.

| Item | Description |
|--------------------|--|
| Keepalive Time | Time after which the router verifies the connection. |
| Keepalive Interval | Length of time that the router waits on an answer. |
| Keepalive Probes | Number of tests that the router performs. |

Table 68: Expansion Port Configuration – *Check TCP connection*

When you mark the *Use CD as indicator of the TCP connection* check box, the router uses the carrier detection (CD) signal to verify the status of the TCP connection. The CD signal verifies that another device is connected to the other side of the cable.

| CD | Description |
|-----------|----------------------------|
| Active | TCP connection is enabled |
| Nonactive | TCP connection is disabled |

Table 69: CD Signal Description

| DTR | Description server | Description client |
|-----------|---|---|
| Active | The router allows the establishment of TCP connections. | The router initiates a TCP connection. |
| Nonactive | The router denies the establishment of TCP connections. | The router terminates the TCP connection. |

Table 70: DTR Signal Description

When you mark the *Use DTR as control of TCP connection* check box, the router uses the data terminal ready (DTR) signal to control the TCP connection. The remote device sends a DTR signal to the router indicating that the remote device is ready for communications.

The changes in settings will apply after pressing the *Apply* button.

4.16.1 Examples of the Expansion Port Configuration

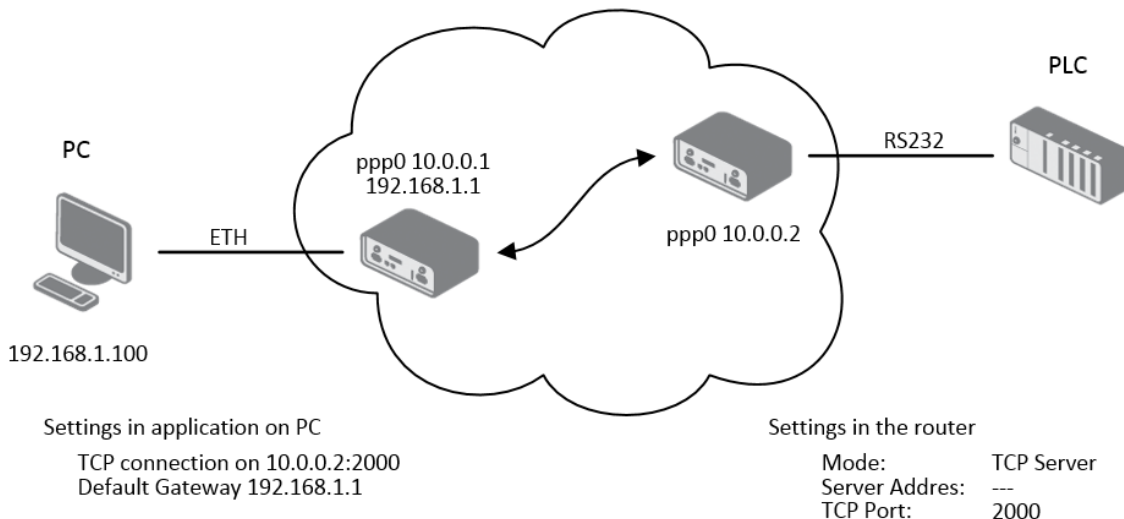

Figure 69: Example of Ethernet to serial communication configuration

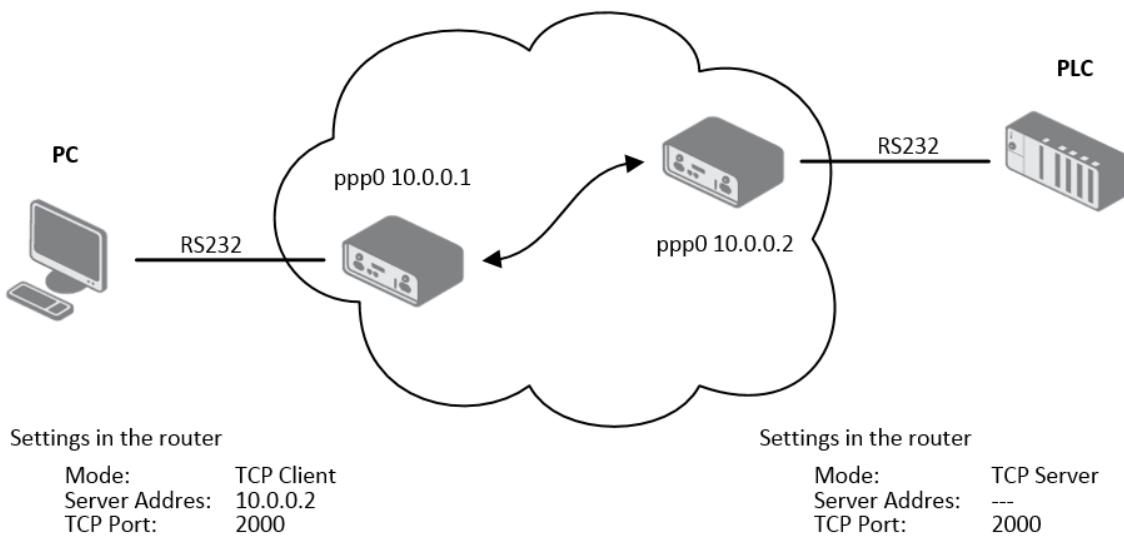

Figure 70: Example of serial interface configuration

4.17 Scripts

There is possibility to create your own shell scripts executed in the specific situations. Go to the *Scripts* page in the *Configuration* section in the menu. The menu item will expand and there are *Startup Script*, *Up/Down IPv4* and *Up/Down IPv6* scripts you can use – there is IPv4 and IPv6 independent dual stack. For more examples of Scripts and possible commands see the Application Note *Commands and Scripts* [1].

4.17.1 Startup Script

Use the *Startup Script* window to create your own scripts which will be executed after all of the initialization scripts are run – right after the router is turned on or rebooted. To save the script press the *Apply* button.



Any changes made to a startup script will take effect next time the router is power cycled or rebooted. This can be done with the *Reboot* button in the *Administration* section, or by SMS message.

4.17.2 Example of Startup Script

Startup Script

Startup Script

```
#!/bin/sh
#
# This script will be executed *after* all the other init scripts.
# You can put your own initialization stuff in here.

killall syslogd
syslogd -R 192.168.2.115 -S 100
```

Figure 71: Example of a Startup Script

When the router starts up, stop `syslogd` program and start `syslogd` with remote logging on address 192.168.2.115 and limited to 100 entries. Add these lines to the startup script:



```
killall syslogd
syslogd -R 192.168.2.115 -S 100
```

4.17.3 Up/Down Scripts

Use the *Up/Down IPv4* and *Up/Down IPv6* page to create scripts executed when the Mobile WAN connection is established (up) or lost (down). There is an independent IPv4 and IPv6 dual-stack implemented in the router, so there is independent IPv4 and IPv6 Up/Down script. *IPv4 Up/Down Script* runs only on the IPv4 WAN connection established/lost, *IPv6 Up/Down Script* runs only on the IPv6 WAN connection established/lost. Any scripts entered into the *Up Script* window will run after a WAN connection is established. Script commands entered into the *Down Script* window will run when the WAN connection is lost.

The changes in settings will apply after pressing the *Apply* button. Also you need to reboot the router to make Up/Down Script work.

4.17.4 Example of IPv6 Up/Down Script

IPv6 Up/Down Script

Up Script

```
#!/bin/sh
#
# This script will be executed when PPP/WAN IPv6 connection is established.

email -t name@domain.com -s "SmartFlex router" -m "PPP connection is established."
```

Down Script

```
#!/bin/sh
#
# This script will be executed when PPP/WAN IPv6 connection is lost.

email -t name@domain.com -s "SmartFlex router" -m "PPP connection is lost."
```

Figure 72: Example of IPv6 Up/Down Script

After establishing or losing an IPv6 WAN connection (connection to mobile network), the router sends an email with information about the connection state. It is necessary to configure *SMTP* before.

Add this line to the *Up Script* field:



```
email -t name@domain.com -s "Router" -m "Connection up."
```

Add this line to the *Down Script* field:



```
email -t name@domain.com -s "Router" -m "Connection down."
```

4.18 Automatic Update Configuration

Use the *Automatic Update* menu to configure the automatic update settings. The router can be configured to automatically check for firmware and configuration updates from a HTTP(S) or FTP(S) server. IPv6 sites/servers are supported. Used protocol is specified by an address in *Base URL* field: HTTP, HTTPS, FTP or FTPS. To prevent possible unwanted manipulation of the files, the router verifies that the downloaded file is in the tar.gz format. At first, the format of the downloaded file is checked. Then the type of architecture and each file in the archive (tar.gz file) is checked.

If the *Enable automatic update of configuration* option is selected, the router will check if there is a configuration file on the remote server, and if the configuration in the file is different than its current configuration, it will update its configuration to the new settings and reboot.

If the *Enable automatic update of firmware* option is checked, the router will look for a new firmware file and update its firmware if necessary.

| Item | Description |
|----------------------|---|
| Base URL | Base URL, IPv4 or IPv6 address from which the configuration file will be downloaded. This option also specifies the communication protocol (HTTP, HTTPS, FTP or FTPS (only implicit mode is supported)), see examples below. |
| Unit ID | Name of configuration (name of the file without extension). If the <i>Unit ID</i> is not filled, the MAC address of the router is used as the filename (the delimiter colon is used instead of a dot.) |
| Update Hour | Use this item to set the hour (range 1-24) when the automatic update will be performed every day. If the time is not specified, automatic update is performed five minutes after turning on the router and then every 24 hours. If the detected configuration file is different from the running one, it is downloaded and the router is restarted automatically. |
| Decryption Password | Password for decryption of crypted configuration file. This is required only in case the configuration is encrypted. |
| Update Window Start | Choose an hour (range from 1 to 24) when the automatic update will be performed on a daily basis. If the time is not specified (set to <i>dynamic</i>), the automatic update is performed five minutes after router boots up and then regularly every 24 hours. |
| Update Window Length | This value defines the period within the update will be done. This period starts at the time set in the <i>Update Window Start</i> field. The exact time, when the update will be done, is generated randomly. |

Table 71: Automatic Update Configuration

The **configuration file** name consists of *Base URL*, hardware MAC address of ETH0 interface and *cfg* extension. Hardware MAC address and *cfg* extension are added to the file name automatically and it isn't necessary to enter them. When the parameter *Unit ID* is enabled, it defines the concrete configuration name which will be downloaded to the router, and the hardware MAC address in the configuration name will not be used.

The **firmware file** name consists of *Base URL*, type of router and *bin* extension. For the proper firmware filename, see the *Update Firmware* page in *Administration* section – it is written out there, see Chapter 6.11.



It is necessary to load two files (*.bin and *.ver) to the HTTP/FTP server. If only the *.bin file is uploaded and the HTTP server sends the incorrect answer of *200 OK* (instead of the expected *404 Not Found*) when the device tries to download the nonexistent *.ver file, then it can happen that the router will download the *.bin file over and over again.



Firmware update can cause incompatibility with the user modules. It is recommended that you update user modules to the most recent version. Information about the user modules and the firmware compatibility is at the beginning of the user module's Application Note.



The automatic update feature is also executed five minutes after the firmware upgrade, regardless of the scheduled time.

4.18.1 Example of Automatic Update

The following example the router checks for new firmware or configuration file each day at 1:00 a.m. This example is given for the SmartStart router.

- Firmware file: <https://example.com/SPECTRE-v3L-LTE.bin>
- Configuration file: <https://example.com/test.cfg>

Automatic Update

Enable automatic update of configuration

Enable automatic update of firmware

Base URL

Unit ID *

Decryption Password *

Update Window Start ▼

Update Window Length * min

** can be blank*

Figure 73: Example of Automatic Update 1

4.18.2 Example of Automatic Update Based on MAC

The following example checks for new firmware or configurations each day between 1:00 a.m. and 3:00 a.m. The configuration file is encrypted, therefore the decryption password was configured. This example is given for the SmartStart router with MAC address 00:11:22:33:44:55.

- Firmware file: <https://example.com/SPECTRE-v3L-LTE.bin>
- Configuration file: <https://example.com/00.11.22.33.44.55.cfg>

Automatic Update

Enable automatic update of configuration

Enable automatic update of firmware

Base URL

Unit ID *

Decryption Password *

Update Window Start ▼

Update Window Length * min

* can be blank

Figure 74: Example of Automatic Update 2

5. Customization

5.1 User Modules

You may run custom software programs in the router to enhance the features of the router. Use the *User Modules* menu item to add new software modules to the router, to remove them, or to change their configuration. Use the *Browse* button to select the user module (compiled module has *tgz* extension). Use the *Add* button to add a user module.

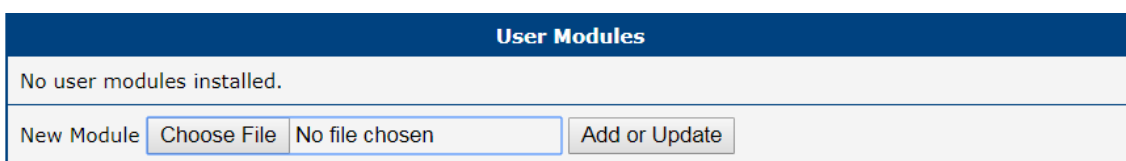

Figure 75: User modules

The new module appears in the list of modules on the same page. If the module contains an *index.html* or *index.cgi* page, the module name serves as a link to this page. The module can be deleted using the *Delete* button.

Updating a module is done the same way. Click the *Add* button and the module with the higher (newer) version will replace the existing module. The current module configuration is left in the same state.



Programming and compiling of modules is described in the Application Note *Programming of User Modules* [10].

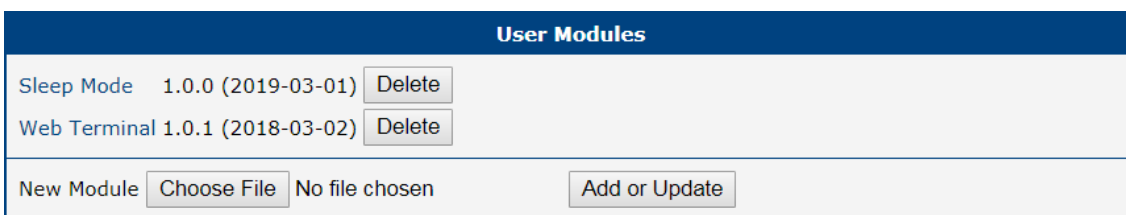

Figure 76: Added user module

User modules can be custom-programmed. Some typical user modules are prepared by the manufacturer and are available on the website for the download.

5.1.1 Examples of Available User Modules

Here are a few examples of the user modules that are available on the website:

Connectivity

| Module name | Description |
|-------------------------|--|
| Band Select | Adjust the portfolio of frequency bands which router supports |
| Backup APN | Switch to a secondary APN if the primary fails |
| Ethernet Mirroring | Mirror traffic from one Ethernet interface to another |
| Modem Bonding | Bond connectivity of multiple routers to a single master |
| PPP Gateway | Provide internet access to older devices connected via a serial line only |
| Transparent mode | Transfer mobile WAN IP address is to connected device on ETH |
| Easy VPN client | Provides secure connection of LAN network behind our router with LAN network behind CISCO router |
| WiFi SSID Switch | Automatically switch between up to four Wi-Fi Access Points |
| WiFi STA Relay | WiFi station transparent mode (interface in client mode bridged to ETH) |
| 802.1X Authenticator | Requires an external RADIUS server List of exempted MAC addresses |
| Layer 2 Firewall (L2FW) | Allow or deny traffic from a given MAC address |
| NAT | Source NAT (SNAT) and Destination NAT (DNAT) |
| URL Blocker | Block selected domain names (URLs) |

Table 72: Connectivity User Modules

Routing

| Module name | Description |
|--------------|--|
| RIP RIPng | RIP v1 (RFC 1058) RIP v2 (RFC 2453) RIPng for IPv6 (RFC 2080) RIP-2 MD5 Authentication (RFC 2082) |

Continued on next page

Continued from previous page

| Module name | Description |
|--------------------------|--|
| OSPF | OSPF v2 (RFC 2328) OSPF v3 for IPv6 (RFC 2740) Opaque LSA Option (RFC 2370) Not-So-Stubby Area (NSSA) (RFC 3101) Stub Router Advertisement (RFC 3137) |
| IPSec-Tools | IPSec-Tools is used for IPsec configuration. This user module uses Racoon instead of OpenSwan. |
| IS-IS | IS-IS (ISO/IEC 10589, RFC 1195) IPv6 support (RFC 5308) |
| NHRP DMVPN | NHRP (RFC 2332) |
| BGP | BGP v4 (RFC 1771) Autonomous Systems (RFC 1965) Communities Attribute (RFC 1997) Capabilities Advertisement (RFC 2842) Multiprotocol Extensions (RFC 2858) Multiprotocol Extensions for IPv6 Inter-Domain Routing (RFC 2545) Route Reflection (RFC 2796) |
| PIM-SM | Revised PIM-SM protocol (RFC 4601) Bootstrap Router (BSR) Mechanism (RFC 5059) |
| OpenVPN custom config | Text-based configuration of OpenVPN tunnels |
| EasyVPN Client | Provides secure (encrypted) connection between two LAN networks |
| Stunnel | Encrypted network tunnel |

Table 73: Routing User Modules

Services

| Module name | Description |
|--------------------|---|
| Captive Portal | Welcome / Ban page for Wi-Fi users Password based authentication Transfer rate limitations Disconnection after given time period or after reaching a data limit Status overview Submission of statistics to an external log server |

Continued on next page

Continued from previous page

| Module name | Description |
|--------------------------|--|
| GPS | Report GPS position via SNMP Forward raw NMEA output to an expansion port and/or remote sockets Synchronize local time |
| NetFlow/IPFIX | NetFlow v5, Netflow v9, or IPFIX protocol Deterministic, random or hash sampler Export to a remote Collector, or to a limited local Collector Intake flows from external Probes |
| NTRIP Client | Help to obtain extremely precise positions by using data from an RTK base station via Ntrip protocol |
| NTP client NTP server | NTPv4 protocol |
| File Uploader | Invoked periodically Downloads files from a given FTP source Uploads files to a given (S)FTP target Removes old files |
| Samba | Windows Share (samba) for the Router directory /var/-data/samba |
| Send Report | Periodically sends System log and Report files to an e-mail and/or FTP |

Table 74: Services User Modules

Administration

| Module name | Description |
|------------------------|--|
| Daily Reboot | Reboot the router at a given time |
| Sleep Mode | Configure the low-power mode at a specific time and/or binary status |
| Customer Logo | Custom image on the Web Admin pages |
| HTTPS Login Banner | Custom information banner ahead of the login form |
| Loopback | Creates a virtual interface for managing the router |
| Ethernet Port Detector | Sends SNMP Trap and/or SMS upon Ethernet cable disconnection |
| Pinger | Automatic line failing / line lost check When line lost, sends SNMP Trap, e-mail or SMS, restarts mobile connection or reboots the router |

Continued on next page

Continued from previous page

| Module name | Description |
|------------------------------|---|
| TCP SYN Keep-Alive | Check ability to setup a TCP connection with a given peer |
| Firmware Over-The-Air (FOTA) | Update firmware of the cellular module "over the air" |
| PduSMS | Send a SMS longer than the common 160 characters |
| CURL | A tool to transfer data (command: curl) |
| SCEP Client | Command line tool for certificate enrollment Protocol per draft-gutmann-scep-16 |
| SSH Client | Secure Shell connection (command: ssh) |
| Ext4 Tools | Support for these commands: mke2fs, e2fsck, mount, umount |
| NMAP | A tool for network exploration and security auditing (command: nmap) |
| Midnight Commander | Visual file manager (command: mc) |
| Vim Editor | Highly configurable text editor (command: vim) |
| Web Terminal | Access to router's console via the web administration GUI |

Table 75: Administration User Modules

Protocol Conversion

| Module name | Description |
|-----------------------------------|--|
| AT Modem Emulator | Converts AT commands to TCP/IP and vice versa HAYES compatible |
| Serial to network proxy (ser2net) | TCP/IP server to access a serial port Telnet control protocol (RFC 2217) |
| Serial2TCP | TCP/IP client to access a serial port from one or more servers |
| Packet Splitter | Splits TCP, UDP or RS232 data flow to multiple targets |
| WoLGateway | Listens on a specific UDP port and forwards traffic to a broadcast address |
| DF1-Ethernet | Converts DF1 serial protocol to AB CSPv4 and/or industrial EtherNet/IP |
| DNP3 Outstation | Provides data from Binary inputs, Analog inputs and Counters DNP routing table |
| IEC101-104 | Converts IEC 60870-5-101 serial protocol to IEC 60870-5-104 IP protocol ASDU conversions |

Continued on next page

Continued from previous page

| Module name | Description |
|-------------------------|--|
| Suite HT of protocols | Forwards TCP/IP queries from an AMR system to a meter on a serial line |
| wM-BUS concentrator | Store messages received via wireless M-BUS to an XML file at a FTP |
| Operating Hours Counter | Resettable and non-resettable time counter for each binary input Value can be retrieved via MODBUS |
| Modbus logger | Logging traffic on a Modbus RTU device connected to the serial interface Store data to a remote FTP(S) server |
| Modbus to LwM2M | Works as Modbus/TCP master Interconnects Modbus/TCP devices with a LwM2M device |
| Modbus to MQTT | Works as MQTT publisher/subscriber Interconnects Modbus/TCP devices with an MQTT broker |
| ALPHA-MODBUS | Converts data from Mitsubishi ALPHA2 to Modbus TCP |
| MODBUS-RTU2TCP | Converts Modbus RTU over serial line into Modbus TCP messages |
| MODBUS-RTUMAP | Maps RTU from more Modbus slaves to one Modbus TCP connection. |
| MODBUS-TCP2RTU | Converts Modbus TCP messages into Modbus RTU over serial line |

Table 76: Protocol Conversion User Modules

Node-RED

| Module name | Description |
|-------------|---|
| FTP Node | LIST, GET, PUT and DELETE files on a remote FTP server |
| GPSd Node | Retrieving data from a GPS Module via the GPSd Service Daemon |
| gzip Node | Compress/decompress tools |
| KNX Node | KNX device, KNX out and KNX in nodes |
| Modbus Node | Serial and TCP Modbus nodes |
| MQTT Node | MQTT Broker node |
| Splunk Node | Publish to Splunk's HTTP Event Collector |

Table 77: Node-RED User Modules

Integration

| Module name | Description |
|-----------------------------|---|
| Cumulocity | https://www.softwareag.cloud/site/product/cumulocity-iot.html |
| Docker | https://www.docker.com/ |
| Eltima USB over Ethernet | https://www.eltima.com/products/usb-over-ethernet/ |
| VPN Portal | https://icr.advantech.cz/products/software/webaccess-vpn |
| WebAccess/DMP | https://icr.advantech.cz/products/software/webaccess-dmp-gen2 |
| Zabbix Agent | https://www.zabbix.com |

Table 78: Integration User Modules

Development

| Module name | Description |
|-----------------------|---|
| Advantech SDK | https://icr.advantech.cz/devzone/advanced-usage-and-scripting |
| Azure IoT SDK Python | https://github.com/Azure/azure-iot-sdk-python |
| Python Python3 | https://www.python.org/ |
| Node.js | https://nodejs.org/en/ |
| LUA | https://www.lua.org/ |
| GDB (GNU Debugger) | https://www.gnu.org/software/gdb/ |

Table 79: Development User Modules



In some cases, the firmware update can cause incompatibility with installed user modules. Some of them are dependent on the Linux kernel version. The best practice is to update user modules to the most recent version.



Information about the user module and the firmware compatibility can be found at the beginning of its Application Note.

6. Administration

6.1 Users



This configuration menu is only available for users with the *admin* role!

For the management of the users, open the *Users* form in the *Administration* section of the main menu. The first part of this configuration form contains an overview of all existing users. The table below describes the meaning of the buttons.

| Button | Description |
|-----------------|--|
| Lock | Locks the user account. This user is not allowed to log in to the router, neither to the web interface or to SSH . |
| Change Password | Allows you to change the password for the corresponding user. Valid characters are not restricted. |
| Delete | Deletes the user account. |

Table 80: Users Overview



Be careful to not lock all users of the *Admin* role. In this state, any user has access rights to configure the users!

The second part of configuration form allows to add a new user. All items are described in the table below.

| Item | Description |
|------------------|---|
| Role | Specifies the type of user account: <ul style="list-style-type: none"> • User – user with basic permissions. • Admin – user with enhanced permissions – has full access to the web GUI, access to the router via Telnet, SSH or SFTP. This user has no the same rights as the superuser on Linux-based systems. |
| Username | Specifies the name of the user having access to log in to the device. |
| Password | Specifies the password for the user. Valid characters are not restricted. |
| Confirm Password | Confirms the password. |

Table 81: Add User



A user with the *User* role cannot access the router via Telnet, SSH or SFTP. Read-only access to the FTP server is allowed.

| User Administration | |
|---|---|
| root | Admin <input type="button" value="Lock"/> <input type="button" value="Change Password"/> |
| test | User <input type="button" value="Lock"/> <input type="button" value="Change Password"/> <input type="button" value="Delete"/> |
| Role | <input type="text" value="User"/> |
| Username | <input type="text"/> |
| Password | <input type="text"/> |
| Confirm Password | <input type="text"/> |
| <input type="button" value="Add User"/> | |

Figure 77: Users

6.2 Change Profile

In addition to the standard profile, up to three alternate router configurations or profiles can be stored in router's non-volatile memory. You can save the current configuration to a router profile through the *Change Profile* menu item. Select the alternate profile to store the settings to and ensure that the *Copy settings from current profile to selected profile* box is checked. The current settings will be stored in the alternate profile after the *Apply* button is pressed. Any changes will take effect after restarting router through the *Reboot* menu in the web administrator or using an SMS message.

Example of using profiles: Profiles can be used to switch between different modes of operation of the router such as PPP connection, VPN tunnels, etc. It is then possible to switch between these settings using the front panel binary input, an SMS message, or Web interface of the router.

| Change Profile | |
|---|---------------------------------------|
| Profile | <input type="text" value="Standard"/> |
| <input type="checkbox"/> Copy settings from current profile to selected profile | |
| <input type="button" value="Apply"/> | |

Figure 78: Change Profile

6.3 Change Password

Use the *Change Password* configuration form in the *Administration* section of the main menu for changing your password used to log on the device. Enter the new password in the *New Password* field, confirm the password using the *Confirm Password* field, and press the *Apply* button. Characters for the password are not restricted.



The default password for the **root** user is printed out on the router's label. To maintain the security of your network change the default password. You can not enable remote access to the router for example, in NAT, until you change the password.

| Change Password | |
|--------------------------------------|-----------------------------------|
| Username | <input type="text" value="root"/> |
| New Password | <input type="text"/> |
| Confirm Password | <input type="text"/> |
| <input type="button" value="Apply"/> | |

Figure 79: Change Password

6.4 Set Real Time Clock

You can set the internal clock directly using the *Set Real Time Clock* dialog in the *Administration* section of in the main menu. You can set the *Date* and *Time* manually. When entering the values manually use the format yyyy-mm-dd as seen in the figure below. You can also adjust the clock using the specified NTP server. IPv4, IPv6 address or domain name is supported. After you enter the appropriate values, click the *Apply* button.

| Set Real Time Clock | |
|--------------------------------------|---|
| Date | <input type="text" value="2019 - 08 - 20"/> |
| Time | <input type="text" value="14 : 45 : 44"/> |
| NTP Server Address | <input type="text"/> |
| <input type="button" value="Apply"/> | |

Figure 80: Set Real Time Clock

6.5 Set SMS Service Center

The function requires you to enter the phone number of the SMS service center to send SMS messages. To specify the SMS service center phone number use the *Set SMS Service Center* configuration form in the *Administration* section of the main menu. You can leave the field blank if your SIM card contains the phone number of the SMS service center by default. This phone number can have a value without an international prefix (xxx-xxx-xxx) or with an international prefix (+420-xxx-xxx-xxx). If you are unable to send or receive SMS messages, contact your carrier to find out if this parameter is required.

Figure 81: Set SMS Service Center Address

6.6 Unlock SIM Card

It is possible to use the SIM card protected by PIN number in the router – just fill in the PIN on the *Mobile WAN Configuration* page. Here you can remove the PIN protection (4–8 digit Personal Identification Number) from the SIM card, if your SIM card is protected by one. Open the *Unlock SIM Card* form in the *Administration* section of the main menu and enter the PIN number in the *SIM PIN* field, then click the *Apply* button. It is applied on the currently enabled SIM card, or on the first SIM card if there is no SIM card enabled at the moment.



The SIM card is blocked after three failed attempts to enter the PIN code. Unblocking of SIM card by PUK number is described in next chapter.

Figure 82: Unlock SIM Card

6.7 Unblock SIM Card

On this page you can unblock the SIM card after 3 wrong PIN attempts or change the PIN code of the SIM card. To unblock the SIM card, go to *Unblock SIM Card* administration page. In both cases enter the PUK code into *SIM PUK* field and new SIM PIN code into *New SIM PIN* field. To proceed click on *Apply* button. It is applied on the currently enabled SIM card, or on the first SIM card if there is no SIM card enabled at the moment.



The SIM card will be permanently blocked after the three unsuccessful attempts of the PUK code entering.

Figure 83: Unblock SIM Card

6.8 Send SMS

You can send an SMS message from the router to test the cellular network. Use the *Send SMS* dialog in the *Administration* section of the main menu to send SMS messages. Enter the *Phone number* and text of your message in the *Message* field, then click the *Send* button. The router limits the maximum length of an SMS to 160 characters. (To send longer messages, install the pduSMS user module).

Figure 84: Send SMS

It is also possible to send an SMS message using CGI script. For details of this method. See the application note *Commands and Scripts* [1].

6.9 Backup Configuration



Keep in mind potential security issues when creating backup, especially for user accounts. Encrypted configuration or secured connection to the router should be used.

You can save actual configuration of the router using the *Backup Configuration* item in the *Administration* menu section. If you click on this item a configuration pane will open, see Figure 85. Here you can choose what will be backed up. You can back up configuration of the router (item *Configuration*) or configuration of all user accounts (item *Users*). Both types of the configuration can be backed up separately or at once into one configuration file.



It is recommended to save the configuration into an encrypted file. If the encryption password is not configured, the configuration is stored into an unencrypted file.

Click on *Apply* button and the configuration will be stored into configuration file (file with *cfg* extension) into a directory according the settings of the web browser. Stored configuration can be later used for its restoration, see Chapter 6.10 for more information.

| Backup Configuration | |
|--|----------------------|
| <input checked="" type="checkbox"/> | Backup configuration |
| <input type="checkbox"/> | Backup users |
| Encryption Password * | <input type="text"/> |
| * can be blank | |
| <input type="button" value="Save Backup"/> | |

Figure 85: Backup Configuration

6.10 Restore Configuration



Due to the different format it is not possible to import user accounts backed up on a router of v1 product line (and older) to a router of v2 product line (and newer). The same limitation is for opposite direction.

You can restore a configuration of the router stored into a file using the *Restore Configuration* form. Click on *Browse* button to navigate to the directory containing the configuration file you wish to load to the router. If the configuration was stored into an encrypted file, the decryption password must be set to decrypt the file successfully. To start the restoration process click on *Apply* button.

| Restore Configuration | |
|--------------------------------------|---|
| Configuration File | <input type="button" value="Choose File"/> No file chosen |
| Decryption Password * | <input type="text"/> |
| * can be blank | |
| <input type="button" value="Apply"/> | |

Figure 86: Restore Configuration

6.11 Update Firmware



For security reasons, we highly recommend updating the router's firmware to the latest version regularly. Downgrading the firmware to an older version than the production version or uploading firmware intended for a different device may cause the malfunction of the device.



The firmware update can cause an incompatibility issue with a user module. It is recommended to update all user modules to the most recent version together with the firmware of the router. Information about the user's module compatibility is available at the beginning of the module's Application Note.



Firmware for the routers can be obtained on the product page on *Engineering Portal*, which is available at <https://icr.advantech.cz/support/router-models>.

Update Firmware administration page shows the current router's firmware version and current firmware name, see Figure 87. On this page, the firmware of the router can be updated as well.

| Update Firmware | |
|---------------------------------------|---|
| Firmware Version : | x.x.x (yyyy-mm-dd) |
| Firmware Name : | xxx.bin |
| New Firmware | <input type="button" value="Choose File"/> No file chosen |
| <input type="button" value="Update"/> | |

Figure 87: Update Firmware Administration Page

To load new firmware to the router, click on *Choose File* button, choose the firmware file and press the *Update* button to start the firmware update.

During the firmware update, the router will display messages, as shown in Figure 88. When done, the router will reboot automatically. When rebooted, click the *here* link to re-open the web interface.

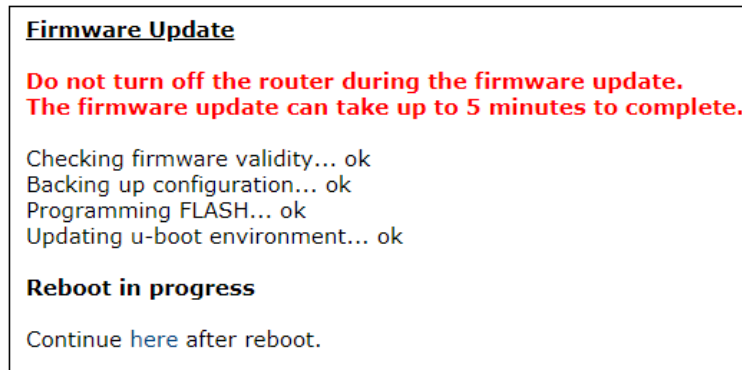

Figure 88: Process of Firmware Update

6.12 Reboot

To reboot the router select the *Reboot* menu item and then press the *Reboot* button.

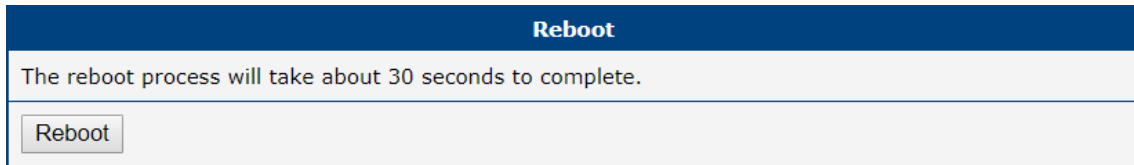

Figure 89: Reboot

6.13 Logout

By clicking the *Logout* menu item, the user is logged out from the web interface.

7. Configuration in Typical Situations

Although Advantech routers have wide variety of uses, they are commonly used in the following ways. All the examples below are for IPv4 networks.

7.1 Access to the Internet from LAN

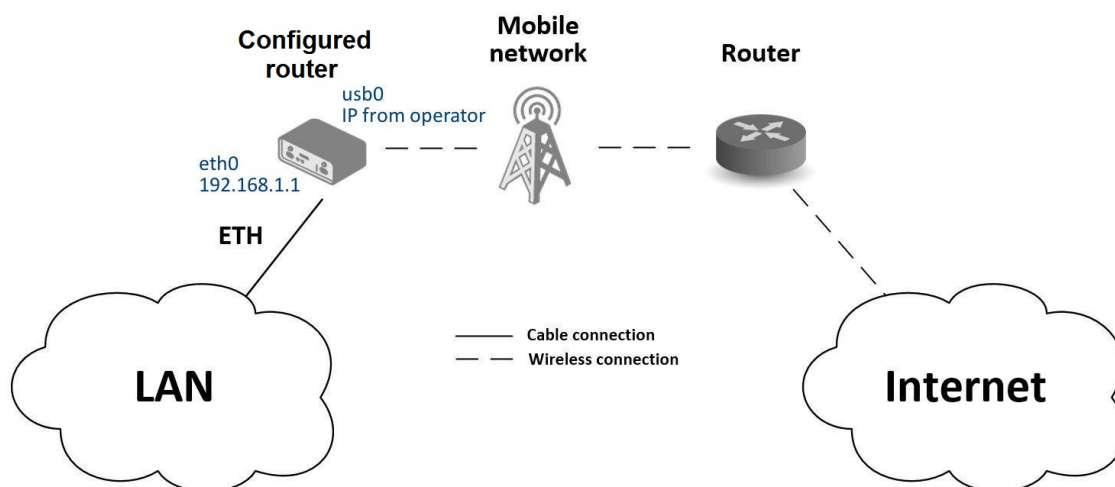

Figure 90: Access to the Internet from LAN – sample topology

In this example, a LAN connecting to the Internet via a mobile network, the SIM card with a data tariff has to be provided by the mobile network operator. This requires no initial configuration. You only need to place the SIM card in the *SIM1* slot (Primary SIM card), attach the antenna to the *ANT* connector and connect the computer (or switch and computers) to the router's *ETH0* interface (LAN). Wait a moment after turning on the router. The router will connect to the mobile network and the Internet. This will be indicated by the LEDs on the front panel of the router (*WAN* and *DAT*).

Additional configuration can be done in the *Ethernet* and *Mobile WAN* items in the *Configuration* section of the web interface.

Ethernet configuration: The factory default IP address of the router's *ETH0* interface is in the form of 192.168.1.1. This can be changed (after login to the router) in the *Ethernet* item in the *Configuration* section, see Figure 91. In this case there is no need of any additional configuration. The *DHCP server* is also enabled by factory default (so the first connected computer will get the 192.168.1.2 IP address etc.). Other configuration options are described in Chapter 4.1.

| Status | ETH0 Configuration | |
|---------------|--|------------------|
| General | IPv4 | IPv6 |
| Mobile WAN | DHCP Client | disabled |
| Network | IP Address | 192.168.1.1 |
| DHCP | Subnet Mask / Prefix | 255.255.255.0 |
| IPsec | Default Gateway | |
| DynDNS | DNS Server | |
| System Log | | |
| Configuration | Bridged | no |
| Ethernet | Media Type | auto-negotiation |
| • ETH0 | <input checked="" type="checkbox"/> Enable dynamic DHCP leases | |
| • ETH1 | IPv4 | IPv6 |
| VRRP | IP Pool Start | 192.168.1.2 |
| Mobile WAN | IP Pool End | 192.168.1.254 |
| PPPoE | Lease Time | 600 |
| Backup Routes | | 600 sec |
| Static Routes | | |
| Firewall | | |
| NAT | | |

Figure 91: Access to the Internet from LAN – Ethernet configuration

Mobile WAN Configuration: Use the *Mobile WAN* item in the *Configuration* section to configure the connection to the mobile network, see Figure 92. In this case (depending on the SIM card) the configuration form can be blank. But make sure that *Create connection to mobile network* is checked (this is the factory default). For more details, see Chapter 4.3.1.

| Status | 1st Mobile WAN Configuration | |
|-------------------|---|---------------------|
| General | <input checked="" type="checkbox"/> Create connection to mobile network | |
| Mobile WAN | 1st SIM card | 2nd SIM card |
| Network | APN * | |
| DHCP | Username * | |
| IPsec | Password * | |
| DynDNS | Authentication | PAP or CHAP |
| System Log | IP Mode | IPv4 |
| Configuration | IP Address * | |
| Ethernet | Dial Number * | |
| VRRP | Operator * | |
| Mobile WAN | Network Type | automatic selection |
| PPPoE | PIN * | |
| Backup Routes | MRU | 1500 bytes |
| Static Routes | MTU | 1500 bytes |
| Firewall | DNS Settings | get from operator |
| NAT | | get from operator |
| OpenVPN | | |
| IPsec | | |
| GRE | | |
| L2TP | | |

Figure 92: Access to the Internet from LAN – Mobile WAN configuration

To check whether the connection is working properly, go to the *Mobile WAN* item in the *Status* section. You will see information about operator, signal strength etc. At the bottom, you should see the message: *Connection successfully established*. The *Network* item should display information about the newly created network interface, usb0 (mobile connection). You should also see the IP address provided by the network operator, as well as the route table etc. The LAN now has Internet access.

7.2 Backup Access to the Internet from LAN

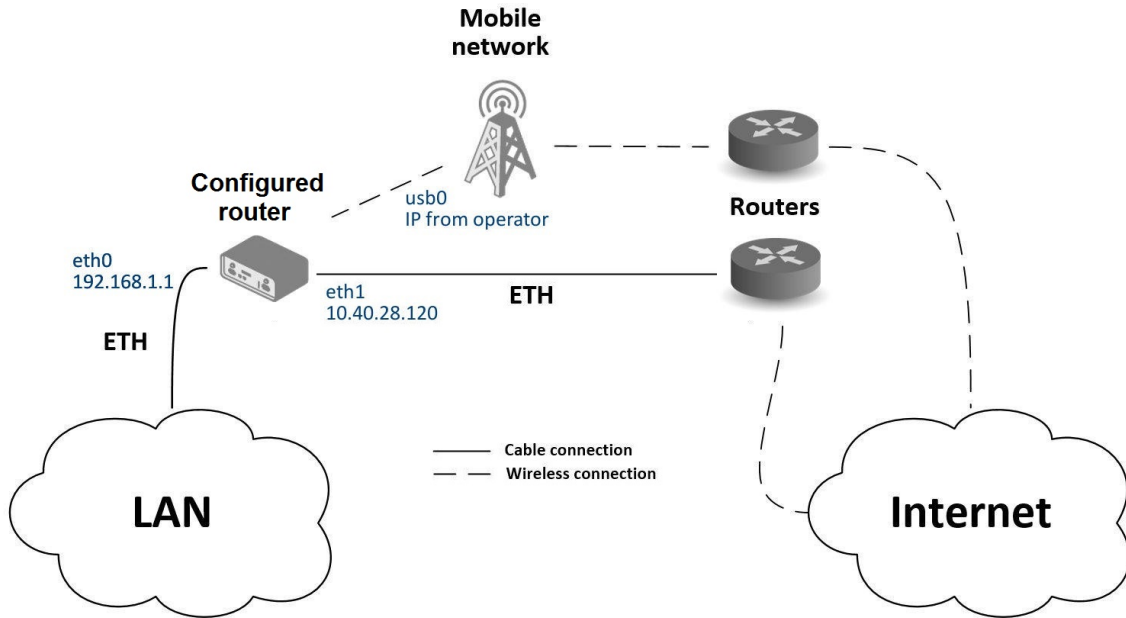

Figure 93: Backup access to the Internet – sample topology

The configuration form on the *Backup Routes* page lets you back up the primary connection with alternative connections to the Internet/mobile network. Each backup connection can be assigned a priority.

| Status | ETH1 Configuration | | |
|--|--------------------|------------------|----------|
| General | | | |
| Mobile WAN | | | |
| Network | | | |
| DHCP | | | |
| IPsec | | | |
| DynDNS | | | |
| System Log | | | |
| Configuration | | | |
| Ethernet | | | |
| • ETH0 | | | |
| • ETH1 | | | |
| VRRP | | | |
| Mobile WAN | | | |
| PPPoE | | | |
| Backup Routes | | | |
| Static Routes | | | |
| Firewall | | | |
| ... | | | |
| | | IPv4 | IPv6 |
| DHCP Client | | disabled | disabled |
| IP Address | | 10.40.28.120 | |
| Subnet Mask / Prefix | | 255.255.252.0 | |
| Default Gateway | | 10.40.30.1 | |
| DNS Server | | 192.168.2.27 | |
| Bridged | | no | |
| Media Type | | auto-negotiation | |
| <input checked="" type="checkbox"/> Enable dynamic DHCP leases | | | |
| IP Pool Start | | 192.168.0.1 | |
| IP Pool End | | 192.168.0.100 | |
| Lease Time | | 600 | 600 sec |

Figure 94: Backup access to the Internet – Ethernet configuration

LAN configuration In the *Ethernet* → *ETH0* item, you can use the factory default configuration as in the previous situation. The *ETH1* interface on the front panel of the router is used for connection to the Internet. It can be configured in *ETH1* menu item. Connect the cable to the router and set the appropriate values as in Figure 94. You may configure the static IP address, default gateway and DNS server. Changes will take effect after you click on the *Apply* button. Detailed Ethernet configuration is described in Chapter 4.1.

Mobile WAN configuration To configure the mobile connection it should be sufficient to insert the SIM card into the *SIM1* slot and attach the antenna to the *ANT* connector. (Depending on the SIM card you are using).

To set up backup routes you will need to enable *Check Connection* in the *Mobile WAN* item. (See Figure 95.) Set the *Check connection* option to *enabled + bind* and fill in an IP address of the mobile operator's DNS server or any other reliably available server and enter the time interval of the check. For detailed configuration, see Chapter 4.3.1.

| Status | 1st Mobile WAN Configuration | |
|-----------------------|---|---|
| General | <input checked="" type="checkbox"/> Create connection to mobile network | |
| Mobile WAN | 1st SIM card | 2nd SIM card |
| Network | APN * | |
| DHCP | Username * | |
| IPsec | Password * | |
| DynDNS | Authentication | PAP or CHAP ▼ PAP or CHAP ▼ |
| System Log | IP Mode | IPv4 ▼ IPv4 ▼ |
| Configuration | IP Address * | |
| Ethernet | Dial Number * | |
| VRRP | Operator * | |
| Mobile WAN | Network Type | automatic selection ▼ automatic selection ▼ |
| PPPoE | PIN * | |
| Backup Routes | MRU | 1500 bytes |
| Static Routes | MTU | 1500 bytes |
| Firewall | DNS Settings | get from operator ▼ get from operator ▼ |
| NAT | DNS IP Address | |
| OpenVPN | DNS IPv6 Address | |
| IPsec | <i>(The feature of check connection to mobile network is necessary for uninterrupted operation)</i> | |
| GRE | Check Connection | enabled + bind ▼ disabled ▼ |
| L2TP | Ping IP Address | 8.8.8.8 |
| PPTP | Ping IPv6 Address | |
| Services | Ping Interval | sec |
| Expansion Port 1 | Ping Timeout | 10 sec |
| Expansion Port 2 | | |
| USB Port | | |
| Scripts | | |
| Automatic Update | | |
| Customization | | |
| User Modules | | |
| Administration | | |

Figure 95: Backup access to the Internet – Mobile WAN configuration

Backup Routes configuration After setting up the backup routes you will need to set their priorities. In Figure 96, the *ETH1* wired connection has the highest priority. If that connection fails, the second choice will be the mobile connection – *usb0* network interface.

The backup routes system must be activated by checking the *Enable backup routes switching* item for each of the routes. Click the *Apply* button to confirm the changes. For detailed configuration see Chapter 4.5.

| Status | Backup Routes Configuration |
|---|---|
| <ul style="list-style-type: none"> General Mobile WAN Network DHCP IPsec DynDNS System Log | <input checked="" type="checkbox"/> Enable backup routes switching Mode: <input type="text" value="Single WAN"/> |
| | <input checked="" type="checkbox"/> Enable backup routes switching for Mobile WAN Priority: <input type="text" value="2nd"/> ← Weight: <input type="text"/> |
| <ul style="list-style-type: none"> Configuration Ethernet VRRP Mobile WAN PPPoE Backup Routes ← Static Routes Firewall NAT OpenVPN IPsec GRE L2TP PPTP Services Expansion Port 1 Expansion Port 2 USB Port Scripts Automatic Update | <input type="checkbox"/> Enable backup routes switching for PPPoE Priority: <input type="text" value="1st"/> Ping IP Address: <input type="text"/> Ping IPv6 Address: <input type="text"/> Ping Interval: <input type="text"/> sec Ping Timeout: <input type="text" value="10"/> sec Weight: <input type="text"/> |
| | <input type="checkbox"/> Enable backup routes switching for ETH0 Priority: <input type="text" value="1st"/> Ping IP Address: <input type="text"/> Ping IPv6 Address: <input type="text"/> Ping Interval: <input type="text"/> sec Ping Timeout: <input type="text" value="10"/> sec Weight: <input type="text"/> |
| | <input checked="" type="checkbox"/> Enable backup routes switching for ETH1 Priority: <input type="text" value="1st"/> ← Ping IP Address: <input type="text"/> Ping IPv6 Address: <input type="text"/> Ping Interval: <input type="text"/> sec Ping Timeout: <input type="text" value="10"/> sec Weight: <input type="text"/> |
| <ul style="list-style-type: none"> Customization User Modules | |
| <ul style="list-style-type: none"> Administration Users Change Profile Change Password Set Real Time Clock Set SMS Service Center | |

Figure 96: Backup access to the Internet – Backup Routes configuration

You can verify the configured network interfaces in the *Status* section in the *Network* item. You will see the active network interfaces: eth0 (connection to LAN), eth1 (wired connection to the Internet) and usb0 (mobile connection to the Internet). IP addresses and other data are included.

At the bottom of the page you will see the *Route Table* and corresponding changes if a wired connection fails or a cable is disconnected the mobile connection will be used.

Backup routes work even if they are not activated in the *Backup Routes* item, but the router will use the factory defaults.

7.3 Secure Networks Interconnection or Using VPN

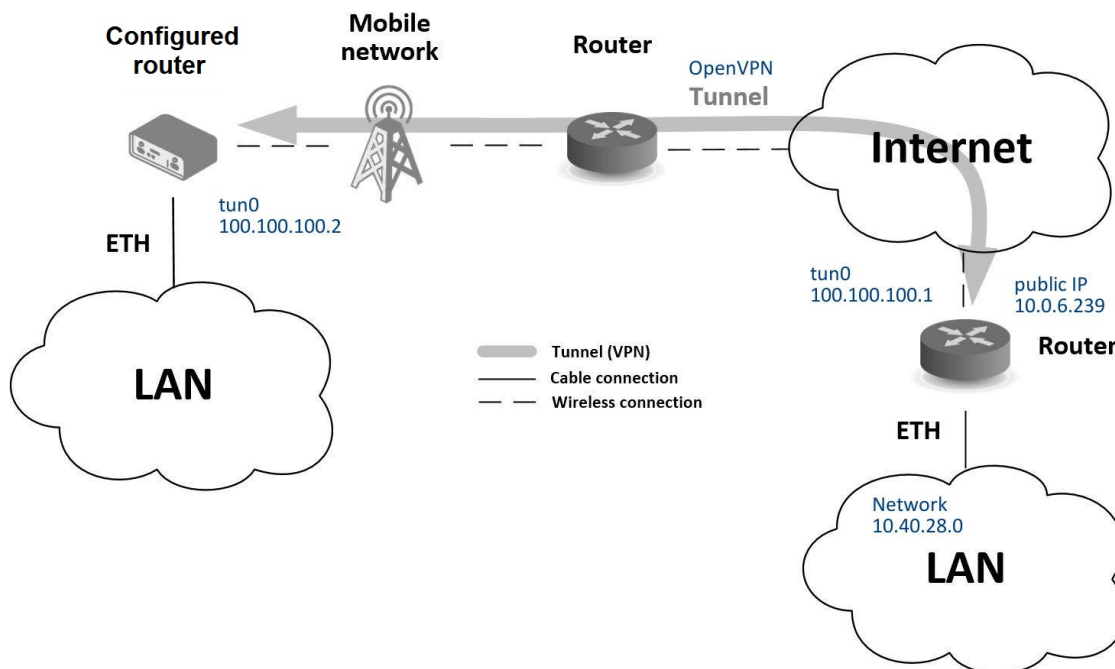

Figure 97: Secure networks interconnection – sample topology

VPN (Virtual Private Network) is a protocol used to create a secure connection between two LANs, allowing them to function as a single network. The connection is secured (encrypted) and authenticated (verified). It is used over public, untrusted networks, see fig. 97. You may use several different secure protocols.

- *OpenVPN* (it is a configuration item in the web interface of the router), see Chapter 4.9 or Application Note [4],
- *IPsec* (it is also configuration item in the web interface of the router), see Chapter 4.10 or Application Note [5].

You can also create non-encrypted tunnels: *GRE*, *PPTP* and *L2TP*. You can use GRE or L2TP tunnel in combination with IPsec to create VPNs.

There is an example of an OpenVPN tunnel in Figure 97. To establish this tunnel you will need the opposite router’s IP address, the opposite router’s network IP address (not necessary) and the pre-shared secret (key). Create the OpenVPN tunnel by configuring the *Mobile WAN* and *OpenVPN* items in the *Configuration* section.

Mobile WAN configuration: The mobile connection can be configured as described in the previous situations. (The router connects itself after a SIM card is inserted into *SIM1* slot and an antenna is attached to the *ANT* connector.)

Configuration is accessible via the *Mobile WAN* item the *Configuration* section, see Chapter 4.3.1). The mobile connection has to be enabled.

OpenVPN configuration: OpenVPN configuration is done with the *OpenVPN* item in the *Configuration* section. Choose one of the two possible tunnels and enable it by checking the *Create 1st OpenVPN tunnel*. You will need to fill in the protocol and the port (according to the settings on the opposite side of the tunnel or Open VPN server). You may fill in the public IP address of the opposite side of the tunnel including the remote subnet and mask (not necessary). The important items are *Local* and *Remote Interface IP Address* where the information regarding the interfaces of the tunnel’s end must be filled in. In the example shown, the *pre-shared secret* is known, so you would choose this option in the *Authentication Mode* item and insert the secret (key) into the field. Confirm the configuration clicking the *Apply* button. For detailed configuration see Chapter 4.9 or Application Note [4].

| Status | 1st OpenVPN Tunnel Configuration | |
|----------------------|---|-------------------------------------|
| General | <input checked="" type="checkbox"/> Create 1st OpenVPN tunnel | |
| Mobile WAN | Description * | myTunnel |
| WiFi | Protocol | UDP |
| Network | UDP Port | 3000 |
| DHCP | Remote IP Address * | 10.0.6.239 |
| IPsec | Remote Subnet * | 10.40.28.0 |
| DynDNS | Remote Subnet Mask * | 255.255.252.0 |
| System Log | Redirect Gateway | no |
| Configuration | | |
| Ethernet | Local Interface IP Address | 100.100.100.2 |
| VRRP | Remote Interface IP Address | 100.100.100.1 |
| Mobile WAN | Remote IPv6 Subnet * | |
| PPPoE | Remote IPv6 Subnet Prefix Length * | |
| WiFi | Local Interface IPv6 Address * | |
| Backup Routes | Remote Interface IPv6 Address * | |
| Static Routes | Ping Interval * | 10 sec |
| Firewall | Ping Timeout * | 30 sec |
| NAT | Renegotiate Interval * | sec |
| OpenVPN | Max Fragment Size * | bytes |
| • 1st Tunnel | Compression | LZO |
| • 2nd Tunnel | NAT Rules | not applied |
| • 3rd Tunnel | Authenticate Mode | pre-shared secret |
| • 4th Tunnel | Security Mode | tls-auth |
| IPsec | Pre-shared Secret | # # 2048 OpenVPN static key # |
| GRE | | |
| L2TP | | |
| PPTP | | |
| Services | | |
| Expansion Port | | |
| Scripts | | |
| Automatic Update | | |

Figure 98: Secure networks interconnection – OpenVPN configuration

The *Network* item in the *Status* section will let you verify the activated network interface tun0 for the tunnel with the IP addresses of the tunnel’s ends set. Successful connection can be verified in the *System Log* where you should see the message: *Initialization Sequence Completed*. The networks are now interconnected. This can also be verified by using the ping program. (Ping between tunnel’s endpoint IP addresses from one of the routers. The console is accessible via SSH).

7.4 Serial Gateway

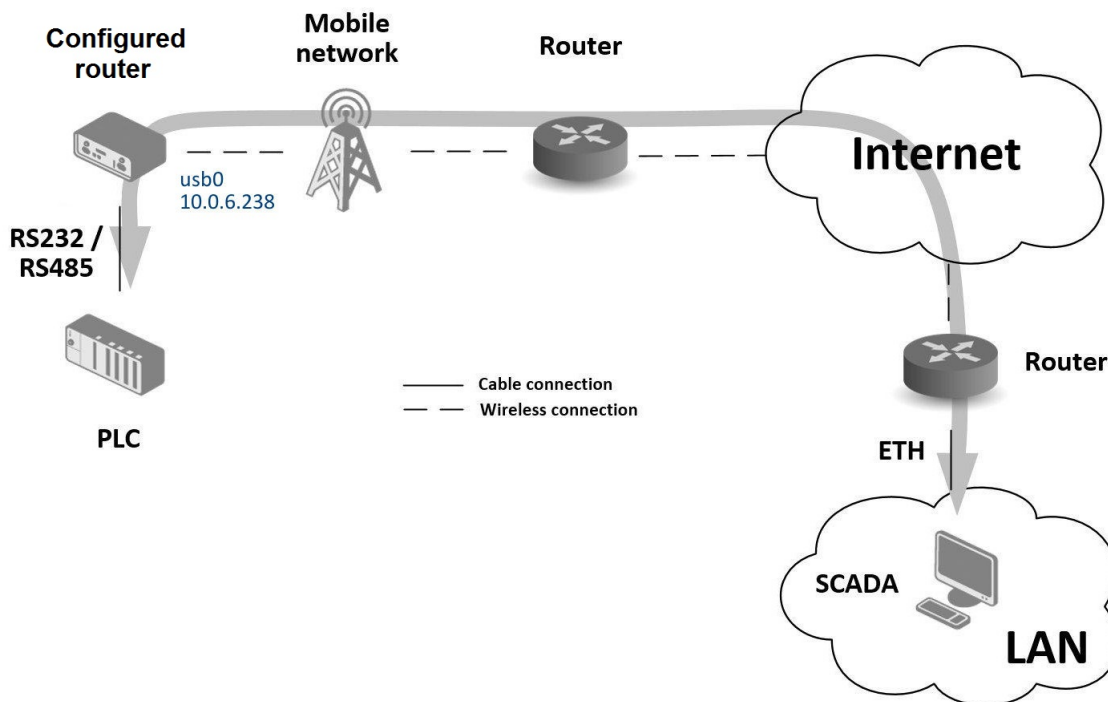

Figure 99: Serial Gateway – sample topology

The router’s serial gateway function lets you establish serial connectivity across the Internet or with another network. Serial devices (meters, PLC, etc.) can then upload and download data, see Figure 99.

Configuration is done in the *Configuration* section, *Mobile WAN*, with the *Expansion Port 1* item for RS232, or *Expansion Port 2* for RS485. In this example, the RS232 interface of the router is used.

Mobile WAN configuration: Mobile WAN configuration is the same as in the previous examples. Just insert the SIM card into the *SIM1* slot at the back of the router and attach the antenna to the *ANT* connector at the front. No extra configuration is needed (depending on the SIM card used). For more details see Chapter 4.3.1.

Expansion Port 1 configuration: The RS232 interface (port) can be configured in the *Configuration* section, via the *Expansion Port 1* item, see Figure 100.) You will need to enable the RS232 port by checking *Enable expansion port 1 access over TCP/UDP*. You may edit the serial communication parameters (not needed in this example). The important items are *Protocol*, *Mode* and *Port*. These set the parameters of communication out to the network and the Internet. In this example the TCP protocol is chosen, and the router will work as a server listening on the 2345 TCP port. Confirm the configuration clicking the *Apply* button.

| Status | Expansion Port Configuration |
|--|---|
| <ul style="list-style-type: none"> General Mobile WAN Network DHCP IPsec DynDNS System Log | <input checked="" type="checkbox"/> Enable expansion port access over TCP/UDP Port Type: <input type="text" value="RS-232"/> Baudrate: <input type="text" value="9600"/> Data Bits: <input type="text" value="8"/> Parity: <input type="text" value="none"/> Stop Bits: <input type="text" value="1"/> Flow Control: <input type="text" value="none"/> Split Timeout: <input type="text" value="20"/> msec Protocol: <input type="text" value="TCP"/> Mode: <input type="text" value="server"/> Server Address: <input type="text"/> TCP Port: <input type="text" value="2345"/> Inactivity Timeout *: <input type="text"/> sec |
| Configuration <ul style="list-style-type: none"> Ethernet <ul style="list-style-type: none"> • ETH0 • ETH1 VRRP Mobile WAN PPPoE Backup Routes Static Routes Firewall NAT OpenVPN IPsec GRE L2TP PPTP Services <ul style="list-style-type: none"> Expansion Port 1 ← Expansion Port 2 USB Port Scripts Automatic Update | <input type="checkbox"/> Reject new connections <input type="checkbox"/> Check TCP connection Keepalive Time: <input type="text" value="3600"/> sec Keepalive Interval: <input type="text" value="10"/> sec Keepalive Probes: <input type="text" value="5"/> <input type="checkbox"/> Use CD as indicator of TCP connection <input type="checkbox"/> Use DTR as control of TCP connection * can be blank |
| Customization | <input type="button" value="Apply"/> |

Figure 100: Serial Gateway – konfigurace *Expansion Port 1*

To communicate with the serial device (PLC), connect from the PC (Labeled as SCADA in Figure 99) as a TCP client to the IP address 10.0.6.238, port 2345 (the public IP address of the SIM card used in the router, corresponding to the usb0 network interface). The devices can now communicate. To check the connection, go to *System Log* (*Status* section) and look for the *TCP connection established* message.

8. Glossary and Acronyms

Backup Routes Allows user to back up the primary connection with alternative connections to the Internet/mobile network. Each backup connection can have assigned a priority. Switching between connections is done based upon set priorities and the state of the connections.

DHCP The Dynamic Host Configuration Protocol (DHCP) is a network protocol used to configure devices that are connected to a network so they can communicate on that network using the Internet Protocol (IP). The protocol is implemented in a client-server model, in which DHCP clients request configuration data, such as an IP address, a default route, and one or more DNS server addresses from a DHCP server.

DHCP client Requests network configuration from [DHCP server](#).

DHCP server Answers configuration request by [DHCP clients](#) and sends network configuration details.

DNS The Domain Name System (DNS) is a hierarchical distributed naming system for computers, services, or any resource connected to the Internet or a private network. It associates various information with domain names assigned to each of the participating entities. Most prominently, it translates easily memorized domain names to the numerical IP addresses needed for the purpose of locating computer services and devices worldwide. By providing a worldwide, distributed keyword-based redirection service, the Domain Name System is an essential component of the functionality of the Internet.

DynDNS client DynDNS service lets you access the router remotely using an easy to remember custom hostname. This client monitors the router's [IP address](#) and updates it whenever it changes.

GRE Generic Routing Encapsulation (GRE) is a tunneling protocol that can encapsulate a wide variety of network layer protocols inside virtual point-to-point links over an Internet Protocol network. It is possible to create four different tunnels.

HTTP The Hypertext Transfer Protocol (HTTP) is an application protocol for distributed, collaborative, hypermedia information systems. HTTP is the foundation of data communication for the World Wide Web.

Hypertext is structured text that uses logical links (hyperlinks) between nodes containing text. HTTP is the protocol to exchange or transfer hypertext.

HTTPS The Hypertext Transfer Protocol Secure (HTTPS) is a communications protocol for secure communication over a computer network, with especially wide deployment on the Internet. Technically, it is not a protocol in and of itself; rather, it is the result of simply layering the Hypertext Transfer Protocol (HTTP) on top of the SSL/TLS protocol, thus adding the security capabilities of SSL/TLS to standard HTTP communications.

IP address An Internet Protocol address (IP address) is a numerical label assigned to each device (e.g., computer, printer) participating in a computer network that uses the Internet Protocol for communication. An IP address serves two principal functions: host or network interface identification and location addressing. Its role has been characterized as follows: *A name indicates what we seek. An address indicates where it is. A route indicates how to get there* The designers of the Internet Protocol defined an IP address as a 32-bit number and this system, known as Internet Protocol Version 4 ([IPv4](#)), is still in use today. However, due to the enormous

growth of the Internet and the predicted depletion of available addresses, a new version of IP (**IPv6**), using 128 bits for the address, was developed in 1995.

IP masquerade Kind of **NAT**.

IP masquerading see **NAT**.

IPsec Internet Protocol Security (IPsec) is a protocol suite for securing Internet Protocol (IP) communications by authenticating and encrypting each IP packet of a communication session. The router allows user to select encapsulation mode (tunnel or transport), IKE mode (main or aggressive), IKE Algorithm, IKE Encryption, ESP Algorithm, ESP Encryption and much more. It is possible to create four different tunnels.

IPv4 The Internet Protocol version 4 (IPv4) is the fourth version in the development of the Internet Protocol (IP) and the first version of the protocol to be widely deployed. It is one of the core protocols of standards-based internetworking methods of the Internet, and routes most traffic in the Internet. However, a successor protocol, **IPv6**, has been defined and is in various stages of production deployment. IPv4 is described in IETF publication RFC 791 (September 1981), replacing an earlier definition (RFC 760, January 1980).

IPv6 The Internet Protocol version 6 (IPv6) is the latest revision of the Internet Protocol (IP), the communications protocol that provides an identification and location system for computers on networks and routes traffic across the Internet. IPv6 was developed by the Internet Engineering Task Force (IETF) to deal with the long-anticipated problem of IPv4 address exhaustion. IPv6 is intended to replace **IPv4**, which still carries the vast majority of Internet traffic as of 2013. As of late November 2012, IPv6 traffic share was reported to be approaching 1%. IPv6 addresses are represented as eight groups of four hexadecimal digits separated by colons

(2001:0db8:85a3:0042:1000:8a2e:0370:7334), but methods of abbreviation of this full notation exist.

L2TP Layer 2 Tunnelling Protocol (L2TP) is a tunnelling protocol used to support virtual private networks (**VPNs**) or as part of the delivery of services by ISPs. It does not provide any encryption or confidentiality by itself. Rather, it relies on an encryption protocol that it passes within the tunnel to provide privacy.

LAN A local area network (LAN) is a computer network that interconnects computers in a limited area such as a home, school, computer laboratory, or office building using network media. The defining characteristics of LANs, in contrast to wide area networks (**WANs**), include their usually higher data-transfer rates, smaller geographic area, and lack of a need for leased telecommunication lines.

NAT In computer networking, Network Address Translation (NAT) is the process of modifying IP address information in IPv4 headers while in transit across a traffic routing device.

The simplest type of NAT provides a one-to-one translation of IP addresses. RFC 2663 refers to this type of NAT as basic NAT, which is often also called a one-to-one NAT. In this type of NAT only the IP addresses, IP header checksum and any higher level checksums that include the IP address are changed. The rest of the packet is left untouched (at least for basic TCP/UDP functionality; some higher level protocols may need further translation). Basic NATs can be used to interconnect two IP networks that have incompatible addressing.

NAT-T NAT traversal (NAT-T) is a computer networking methodology with the goal to establish and maintain Internet protocol connections across gateways that implement network address translation (**NAT**).

NTP Network Time Protocol (NTP) is a networking protocol for clock synchronization be-

tween computer systems over packet-switched, variable-latency data networks.

OpenVPN OpenVPN implements virtual private network (VPN) techniques for creating secure point-to-point or site-to-site connections. It is possible to create four different tunnels.

PAT Port and Address Translation (PAT) or Network Address Port Translation (NAPT) see [NAT](#).

Port In computer networking, a Port is an application-specific or process-specific software construct serving as a communications endpoint in a computer's host operating system. A port is associated with an IP address of the host, as well as the type of protocol used for communication. The purpose of ports is to uniquely identify different applications or processes running on a single computer and thereby enable them to share a single physical connection to a packet-switched network like the Internet.

PPTP The Point-to-Point Tunneling Protocol (PPTP) is a tunneling protocol that operates at the Data Link Layer (Layer 2) of the OSI Reference Model. PPTP is a proprietary technique that encapsulates Point-to-Point Protocol (PPP) frames in Internet Protocol (IP) packets using the Generic Routing Encapsulation (GRE) protocol. Packet filters provide access control, end-to-end and server-to-server.

RADIUS Remote Authentication Dial-In User Service (RADIUS) is a networking protocol that provides centralized Authentication, Authorization, and Accounting (AAA or Triple A) management for users who connect and use a network service. Because of the broad support and the ubiquitous nature of the RADIUS protocol, it is often used by ISPs and enterprises to manage access to the Internet or internal networks, wireless networks, and integrated e-mail services.

Root certificate In cryptography and computer security, a root certificate is either an unsigned public key certificate or a self-signed certificate that identifies the Root Certificate Author-

ity (CA). A root certificate is part of a public key infrastructure scheme. The most common commercial variety is based on the ITU-T X.509 standard, which normally includes a digital signature from a certificate authority (CA).

Digital certificates are verified using a chain of trust. The trust anchor for the digital certificate is the Root Certificate Authority (CA). See [X.509](#).

Router A router is a device that forwards data packets between computer networks, creating an overlay internetwork. A router is connected to two or more data lines from different networks. When a data packet comes in one of the lines, the router reads the address information in the packet to determine its ultimate destination. Then, using information in its routing table or routing policy, it directs the packet to the next network on its journey. Routers perform the *traffic directing* functions on the Internet. A data packet is typically forwarded from one router to another through the networks that constitute the internetwork until it reaches its destination node.

SFTP Secure File Transfer Protocol (SFTP) is a secure version of File Transfer Protocol (FTP), which facilitates data access and data transfer over a Secure Shell (SSH) data stream. It is part of the [SSH](#) Protocol. This term is also known as SSH File Transfer Protocol.

SMTP The SMTP (Simple Mail Transfer Protocol) is a standard e-mail protocol on the Internet and part of the TCP/IP protocol suite, as defined by IETF RFC 2821. SMTP defines the message format and the message transfer agent (MTA), which stores and forwards the mail. SMTP by default uses TCP port 25. The protocol for mail submission is the same, but uses port 587. SMTP connections secured by SSL, known as [SMTPS](#), default to port 465.

SMTPS SMTPS (Simple Mail Transfer Protocol Secure) refers to a method for securing SMTP with transport layer security. For more information about SMTP, see description of the [SMTP](#).

SNMP The Simple Network Management Protocol (SNMP) is an *Internet-standard protocol for managing devices on IP networks*. Devices that typically support SNMP include routers, switches, servers, workstations, printers, modem racks, and more. It is used mostly in network management systems to monitor network-attached devices for conditions that warrant administrative attention. SNMP is a component of the Internet Protocol Suite as defined by the Internet Engineering Task Force (IETF). It consists of a set of standards for network management, including an application layer protocol, a database schema, and a set of data objects.

SSH Secure Shell (SSH), sometimes known as Secure Socket Shell, is a UNIX-based command interface and protocol for securely getting access to a remote computer. It is widely used by network administrators to control Web and other kinds of servers remotely. SSH is actually a suite of three utilities – `slogin`, `ssh`, and `scp` – that are secure versions of the earlier UNIX utilities, `rlogin`, `rsh`, and `rcp`. SSH commands are encrypted and secure in several ways. Both ends of the client/server connection are authenticated using a digital certificate, and passwords are protected by being encrypted.

TCP The Transmission Control Protocol (TCP) is one of the core protocols of the Internet protocol suite (IP), and is so common that the entire suite is often called TCP/IP. TCP provides reliable, ordered, error-checked delivery of a stream of octets between programs running on computers connected to a local area network, intranet or the public Internet. It resides at the transport layer.

Web browsers use TCP when they connect to servers on the World Wide Web, and it is used to deliver email and transfer files from one location to another.

UDP The User Datagram Protocol (UDP) is one of the core members of the Internet protocol suite (the set of network protocols used for the Internet). With UDP, computer applications can send

messages, in this case referred to as datagrams, to other hosts on an Internet Protocol (IP) network without prior communications to set up special transmission channels or data paths. The protocol was designed by David P. Reed in 1980 and formally defined in RFC 768.

URL A uniform resource locator, abbreviated URL, also known as web address, is a specific character string that constitutes a reference to a resource. In most web browsers, the URL of a web page is displayed on top inside an address bar. An example of a typical URL would be <http://www.example.com/index.html>, which indicates a protocol (`http`), a hostname (`www.example.com`), and a file name (`index.html`). A URL is technically a type of uniform resource identifier (URI), but in many technical documents and verbal discussions, URL is often used as a synonym for URI, and this is not considered a problem.

VPN A virtual private network (VPN) extends a private network across a public network, such as the Internet. It enables a computer to send and receive data across shared or public networks as if it were directly connected to the private network, while benefiting from the functionality, security and management policies of the private network. This is done by establishing a virtual point-to-point connection through the use of dedicated connections, encryption, or a combination of the two.

A VPN connection across the Internet is similar to a wide area network (WAN) link between the sites. From a user perspective, the extended network resources are accessed in the same way as resources available from the private network.

VPN server see [VPN](#).

VPN tunnel see [VPN](#).

VRRP VRRP protocol (Virtual Router Redundancy Protocol) allows you to transfer packet routing from the main router to a backup router in case the main router fails. (This can be used

to provide a wireless cellular backup to a primary wired router in critical applications).

WAN A wide area network (WAN) is a network that covers a broad area (i.e., any telecommunications network that links across metropolitan, regional, or national boundaries) using private or public network transports. Business and government entities utilize WANs to relay data among employees, clients, buyers, and suppliers from various geographical locations. In essence, this mode of telecommunication allows a business to effectively carry out its daily function regardless of location. The Internet can be considered a WAN as well, and is used by businesses, governments, organizations, and individuals for almost any purpose imaginable.

WebAccess/DMP WebAccess/DMP is an advanced Enterprise-Grade platform solution for provisioning, monitoring, managing and config-

uring Advantech's routers and IoT gateways. It provides a zero-touch enablement platform for each remote device.

WebAccess/VPN WebAccess/VPN is an advanced VPN management solution for safe interconnection of Advantech routers and LAN networks in public Internet. Connection among devices and networks can be regional or global and can combine different technology platforms and various wireless, LTE, fixed and satellite connectivities.

X.509 In cryptography, X.509 is an ITU-T standard for a public key infrastructure (PKI) and Privilege Management Infrastructure (PMI). X.509 specifies, amongst other things, standard formats for public key certificates, certificate revocation lists, attribute certificates, and a certification path validation algorithm.

9. Index

A

| | |
|----------------------------|-----|
| Accessing the router | 8 |
| Add User | 140 |
| APN | 40 |
| AT commands | 114 |

B

| | |
|----------------------------|-----|
| Backup Configuration | 145 |
| Backup Routes | 52 |
| Bridge | 28 |

C

| | |
|-----------------------------|-----|
| Change Password | 142 |
| Change Profile | 141 |
| Clock synchronization | 101 |
| Configuration update | 129 |
| Control SMS messages | 112 |

D

| | |
|--------------------------|-------------|
| Data limit | 45 |
| Default Gateway | 27 |
| Default IP address | 8 |
| Default password | 8 |
| Default SIM card | 47 |
| Default username | 8 |
| DHCP | 19, 27, 159 |
| DHCPv6 | 28 |
| Dynamic | 29 |
| Static | 29 |
| DHCPv6 | 19, 27 |
| DNS | 159 |
| DNS server | 27, 44 |
| DNS64 | 17 |
| Domain Name System | see DNS |
| DoS attacks | 59 |

Dynamic Host Configuration Protocol

DHCP

| | |
|----------------|--------|
| DynDNS | 23, 98 |
| DynDNSv6 | 23, 98 |

E

| | |
|----------------|-----|
| Expansion Port | |
| RS232 | 123 |
| RS485 | 123 |

F

| | |
|--------------------------------------|----------|
| Firewall | 57 |
| Filtering of Forwarded Packets | 58 |
| Filtering of Incoming Packets | 58 |
| Protection against DoS attacks | 59 |
| Firmware update | 129, 147 |
| Firmware version | 11 |
| FTP | 99 |

G

| | |
|-----------|---------|
| GRE | 89, 159 |
|-----------|---------|

H

| | |
|------------|-----|
| HTTP | 100 |
|------------|-----|

I

| | |
|--------------------------|---------|
| ICMPv6 | 44 |
| IPsec | 75, 160 |
| Authenticate Mode | 81 |
| Encapsulation Mode | 79 |
| IKE Mode | 79 |
| IPv4 | 160 |

IPv6 10, 17, 26, 29, 40, 44, 57, 62, 69, 75, 98, 128

L

L2TP 92, 160
 LAN
 ETH0 26
 ETH1 26
 IPv6 26
 PoE PSE 28
 Location Area Code 12
 Logout 149

M

Mobile network 40
 Multiple WANs 52, 56

N

NAT 62, 160
 NAT64 17
 Network Address Translation *see* NAT
 NTP 101, 160
 NTP server 142

O

Object Identifier 106
 OpenVPN 69, 161
 Authenticate Mode 71

P

PAM 102
 Password 142
 PAT 62
 PIN number 143
 PLMN 12
 PoE PSE 28
 Port 161

PPPoE 50
 PPPoE Bridge Mode 49
 PPTP 95, 161
 Prefix delegation 29
 PUK number 144

R

RADIUS 30
 Reboot 149
 Remote access 64
 Restore Configuration 146
 Router 1
 Accessing 8
 Equipment 1

S

Save Log 24
 Save Report 24
 Send SMS 144
 Serial line
 RS232 123
 RS485 123
 Serial number 11
 Set internal clock 142
 Signal Quality 12
 Simple Network Management Protocol *see* SNMP
 SMS 111
 SMS Service Center 143
 SMTP 109, 161
 SNMP 105, 162
 SSH 120
 Startup Script 127
 Static Routes 56
 Switch between SIM Cards 45
 Syslog 121
 System Log 24

T

TCP 162
 Telnet 122

Transfer speed 1
 Transmission Control Protocol *see* TCP

U

UDP 162
 Unblock SIM card 144
 Uniform resource locator *see* URL
 Unlock SIM card 143
 Up/Down script 128
 URL 162
 Usage Profiles 141
 User Datagram Protocol *see* UDP
 User Module 133

Users 140

V

Virtual private network *see* VPN
 VPN 162
 VRRP 37, 162

W

Web interface 8
 WireGuard 84

10. Related Documents

- [1] Advantech Czech: [Commands and Scripts Application Note](#)
- [2] Advantech Czech: [WebAccess/VPN Application Note](#)
- [3] Advantech Czech: [R-SeeNet Application Note](#)
- [4] Advantech Czech: [OpenVPN Tunnel Application Note](#)
- [5] Advantech Czech: [IPsec Tunnel Application Note](#)
- [6] Advantech Czech: [GRE Tunnel Application Note](#)
- [7] Advantech Czech: [WireGuard Application Note](#)
- [8] Advantech Czech: [SNMP Object Identifiers Application Note](#)
- [9] Advantech Czech: [AT Commands Application Note](#)
- [10] Advantech Czech: [Programming of User Modules Application Note](#)
- [11] Advantech Czech: [Security Guidelines Application Note](#)



[EP] Product-related documents and applications can be obtained on *Engineering Portal* at <https://icr.advantech.cz/download> address.



[UM] User modules and related documents can be obtained on *Engineering Portal* at <https://icr.advantech.cz/products/software/user-modules> address.