

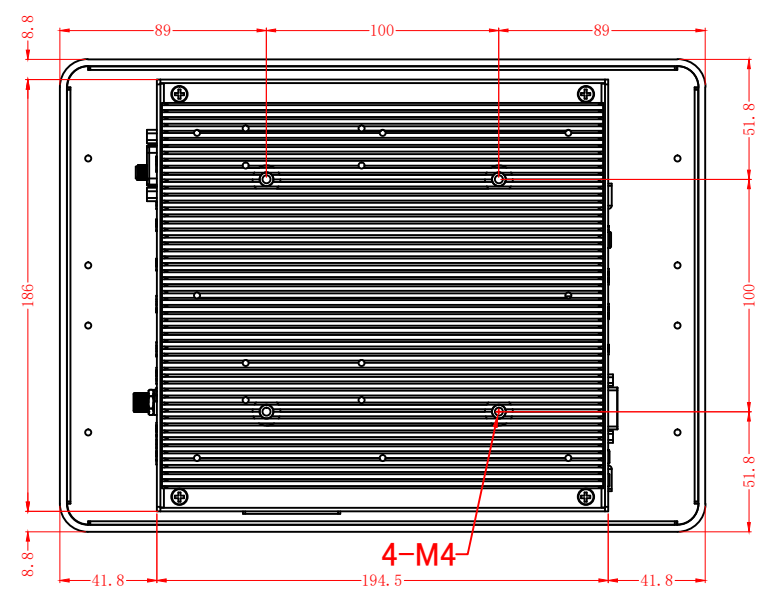

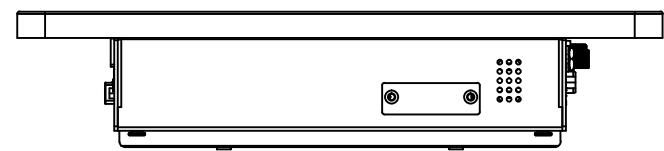

No.	Rev.	Revision Record	Date
△			

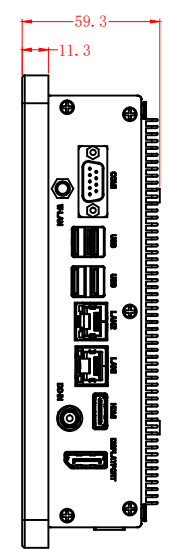
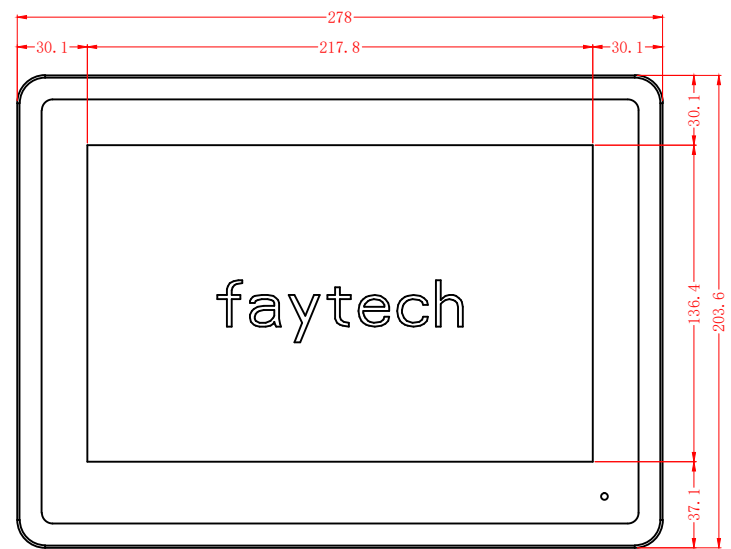
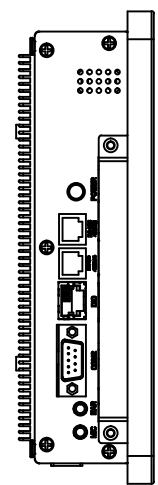
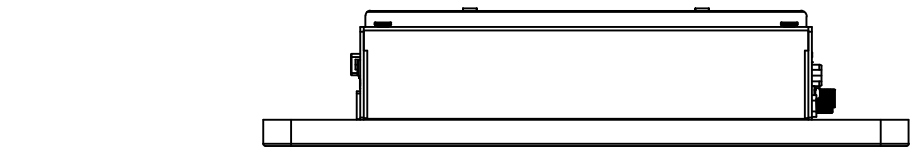

Tolerance: ±1MM

General Tolerance	ISO 2768-lc	 深圳市飞帆泰科技有限公司 SHENZHEN FEIFANTAI TECHNOLOGY CO., LTD			
UNIT	mm	Description		10.1inch-i5	
Scale	1:1	Designed	jiangfan	Date	2020-03-13
REV.	A0	Checked		Date	
		Approved		Date	

