

TREK-303RH

7" In-Vehicle Smart Display



Features

- Vehicle grade 7" (16:10) WVGA resolution TFT LCD with 4-wire Resistive Touchscreen
- Five user-programmable function keys
- Single 2-watt speaker
- Built-in light sensor for automatic dimming
- Easily installed and paired with TREK computing box via a single-cable connection
- Extended I/O ports (USB 2.0 Type A, power button and reset button) for TREK computing box maintenance
- Wide working temperature range (-30° C ~ 70° C)

Introduction

The TREK-303 is a vehicle display system for Mobile Resource Management (MRM) applications in trucks, buses and taxis. The TREK-303 touch panel is the perfect size for tight spaces; ideal for fleet management and dispatch applications. It also meets requirements for automotive grade working temperatures (-30 ~ 70° C). TREK-303 provides excellent display capabilities, featuring light-weight housing, compatible with RAM mounting solutions that customers can easily install. TREK-303 is designed with drivers in mind: when the system requires powering up or waking up, it can be easily controlled from the button located in back; and for night driving, the panel has an auto detecting light sensor to automatically adjust brightness. TREK-303 is a smart display designed especially for truck, bus, and taxi drivers.

Specifications

LCD	Design Compatible Models	Paired with TREK computing box (i.e. TREK-5xx/6xx)
	Resolution (pixel)	WVGA (800 x 480)
	Video Input	Single channel, 18 bit LVDS
	Pixel Pitch	0.2168 (H) x 0.2168 (V)
	Brightness (cd/m ²)	500 (typical)
	View Angle ((H/V))	140° /120°
	Contrast Ratio	500
	Backlight Life (Hrs)	50K
	Backlight Type	LED
Touchscreen	Size	7" format
	Type	4-wire Resistive
	Transparency	84% ± 3%
	Hardness	3H
	Durability	Knock test > 200,000 times (Stylus= R0.8, <=250g)
	IK Shock-Protection Rate	N/A (IK-07, by project-based)
Front Panel	Speaker	2 x 2-watt speaker
	Hotkey	5 x User-programmable Function keys with green LED
	Brightness Control	Manually controlled by button (default), Light sensing (optional)
	USB Port	1 x USB 2.0 Host Type A (Data access from/to TREK computing box)
Rear I/O	Smart Display Port	1 x 36-pin locking type high density connector to be paired with TREK-5xx/6xx
	Power button	1 x Power button (To power on/off TREK computing box)
	Reset button	1 x Reset button (To Reset TREK computing box)
Power	DC Input	12 V ± 5% (Powered by TREK computing box directly)
	Power Consumption	7W (Nominal), 12W (Max.)
Mechanical	Mounting	Design compatible with RAM mount
	Material	PC
	Weight	0.95 kg
	Dimensions (W x H x D)	244 mm x 160 mm x 41 mm
Environment	Operating Temperature	-30 to + 70° C
	Storage Temperature	-40 to + 80° C
	Vibration	MIL-STD-810G, SAE J1455 4.9.4.2
	Certifications	CE, FCC, CCC, E-MARK (E13)
	IP Rating	IP 31 (entire system), IP 54 (with I/O Cover, by project-based)

Dimensions

Unit: mm

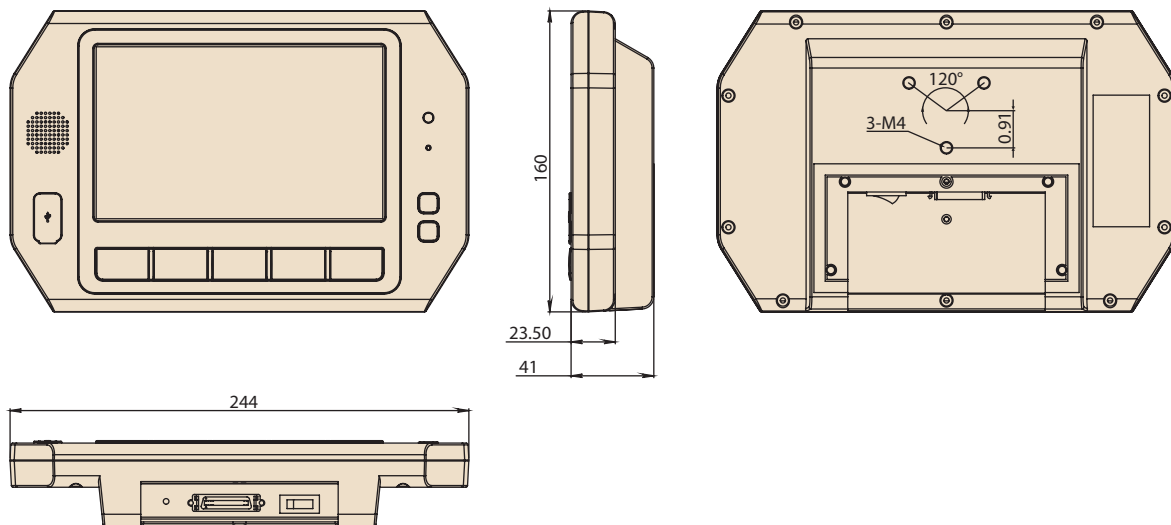

I/O Connectors

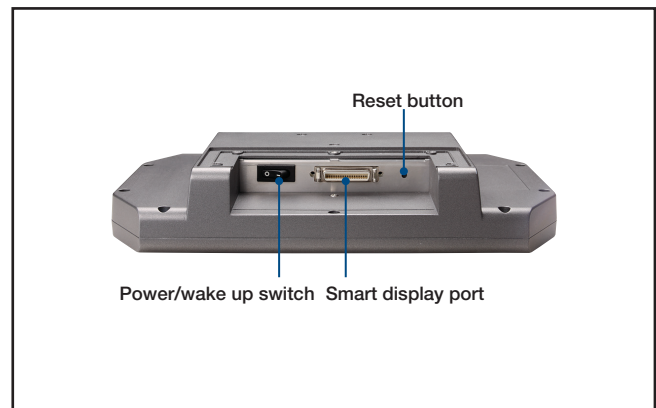
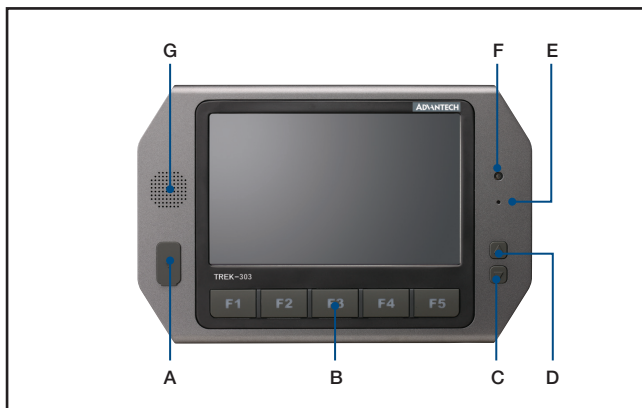

- A. USB Host
- B. 5 programmable hotkeys
- C. D. Brightness control
- E. Power LED
- F. Light sensor
- G. Speaker

Note: Backlight off: Press C button to the lowest level

Ordering Information

Part Number	Description
TREK-303R-HA0E	7" WVGA in-vehicle Smart Display, with 4-wire Resistive Touchscreen

Optional Items

Part Number	Description
RAM-Mount-07E	75mm VESA base, RAM-202U, and socket ARM
RAM-Mount-09E	Clamp base, RAM-202U, and socket ARM
TREK-MNT-301E	AMPS mount, TRIAXIS arm, AMPS base (ONYX)
TREK-MNT-302E	AMPS mount, TRIAXIS arm, VASA base (ONYX)
1700020007	2-meter smart display cable (Paired with TREK-5xx/6xx)
1700020008	5-meter smart display cable (Paired with TREK-5xx/6xx)