

ARK-2151V

In-Vehicle Full HD NVR w/4 PoE Ports 4th Gen. Intel® Core i5 4300U / Celeron 2980U SoC Fanless Box PC



Features

- Intel® Celeron 2980U 1.6GHz / Core i5-4300U 1.9 GHz SoC
- 4 PoE Ports to Support Mainstream IP Cameras
- Diversity Communication Abilities, ex. WWAN, WLAN
- Built-in GPS and G-Sensor for GIS application
- Intelligent Vehicle Power Ignition
- 9 ~ 36 V_{DC}* Wide Power Input w/isolation
- 1 x Removable 2.5" drive bay
- Supports iManager, SUSIAccess and Embedded Software APIs

Specifications

		ARK-2151V-S6A1E	ARK-2151V-S9A1E
Processor System	CPU	Intel Celeron 2980U Dual Core	Intel i5-4300U Dual Core
	Frequency	1.6 GHz	1.9 GHz
	L3 Cache	2 MB	3 MB
	BIOS	AMI EFI 128 Mbit	
Memory	Technology	DDR3L 1333 MHz	DDR3L 1600 MHz
	Max. Capacity	8 GB	
	Socket	1 x 204-pin SO-DIMM	
Graphics	Chipset	HD Graphics	GT2-4400 Graphics
	Graphic Engine	DirectX11.1, OpenGL 4.0, and OpenCL 1.2	
	VGA	Full AVC/VC1/MPEG2 HW Decode	
	HDMI	Up to 1920 x 1200 with 60 Hz, 154 MHz pixel clock rate	
Audio	Main System	Realtek ALC888S, High Definition Audio (HD), Line-in, Line out, Mic-in	
Ethernet	LAN #1	10/100/1000 Mbps Intel I218 GbE, support Wake on LAN	
	LAN #2	10/100/1000 Mbps Intel I210-IT, support Wake on LAN	
I/O Interface	Power over Ethernet, PoE	N/A	4 x 10/100 Mbps - 4ports full-load, IEEE802.3af Class 2 (7Watt) - 2ports full-load, IEEE802.3af Class 3 (15.4Watt)
	Serial Ports	2 x RS-232/422/485 ports w/ 3KV isolation (support auto flow control, jumper selectable)	N/A
	Optional COM or CANBus	2 x DB9 connectors for RS-232/422/485 signal (Default) or CANBus 2.0A/B (Module option)	
	USB Interface	2 x USB 2.0 & 2 x USB3.0	
	GPIO	6 x DI & 2 x DO w/ 3KV isolation Input Voltage: 0 to 30 V _{DC} , Output Current: Max. 500 mA per channel On-state Voltage: 24 V _{DC} nominal, open collector to 30 V _{DC}	
Other	GPS	On board standalone GPS, support GPS, GLONASS and QZSS signals	
	G-Sensor	On board high resolution G-Sensor, up to 13-bit resolution at ±16g	
	Watchdog timer	255-level timer interval, setup by software	
Expansion	Mini PCIe #1	Full-size Mini PCIe, support mSATA	
	Mini PCIe #2	Half-size Mini PCIe, support WLAN module	
	Mini PCIe #3/4	2 x Full-size Mini PCIe w/SIM holders, support WWAN module (USB interface)	
Storage	2.5" Drive Bay	1 x removable 2.5" drive bay (Max 9.5mm height)	
	mSATA	Leverage MiniPCIe #1 slot	
Software Support	Microsoft Windows	WES8, WES7, Windows 8, Windows 7	
	Linux	Support by project	
Power Requirement	Power Type	ATX/AT	
	Power Input Voltage*	9 ~ 36 V _{DC} w/isolation	
	Vehicle Power Ignition	Selectable boot-up & shut-down voltage, on/off delay time	
	Isolation	1.5 KV Isolated	
Mechanical	Construction	Aluminum housing, Silver	
	Mounting	Din-Rail mounting, Desk/wall-mounting, VESA mounting	
Environment	Dimensions (W x H x D)	264.5 x 75.1 x 133.0 mm (10.41" x 2.96" x 5.24")	
	Operating Temperature	With extended temperature peripherals:-20 ~ 60° C with 0.7m/s air flow	
	Storage Temperature	With standard temperature peripherals:0 ~ 45° C with 0.7m/s air flow	
	Relative Humidity	-40 ~ 85° C (-40~185° F)	
Regulation	Vibration/Shock	95% @ 40° C (non-condensing)	
	EMC	With mSATA/SSD: IEC 60721-3-5 Class 5M3	
Regulation	Safety	CE/FCC Class A, CCC, BSMI	
	In-Vehicle Power	UL, CCC, BSMI, E-Mark (E13) ISO7637-2 Lev.4	

* Power Input Constraint at low voltage: 9~10.9V.

Dimensions

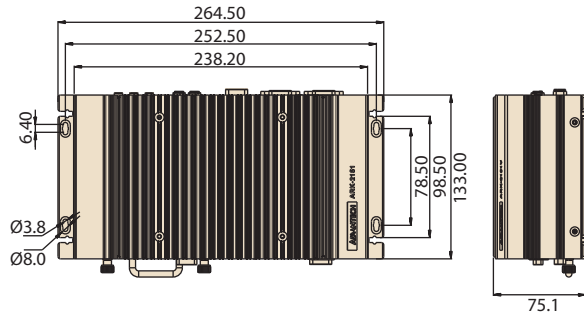

DIN Rail

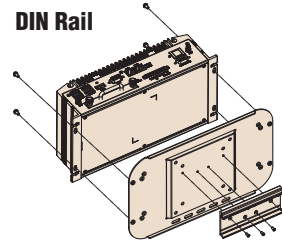

Unit: mm

VESA mount

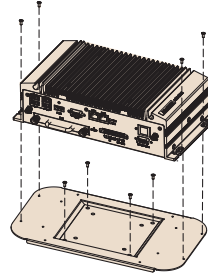

Wall mount

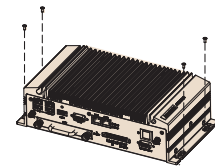

ARK-2151V-S6A1E External I/O Mechanical Layout/Drawing

Front Panel

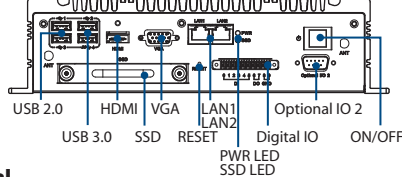

Rear Panel

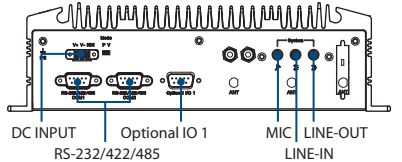

ARK-2151V-S9A1E External I/O Mechanical Layout/Drawing

Front Panel

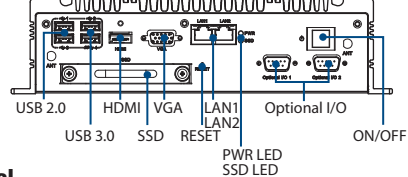

Rear Panel

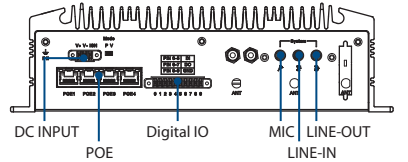

Ordering Information

Part Number	Intel CPU	RAM	2.5" Drive	mSATA	Display	GbE	PoE	USB	DIO	Optional COM or CANBus	RS-232/422/485	MiniPCIe	SIM Holder	Power Input	Operating Temperature
ARK-2151V-S6A1E	Intel Celeron 2980U 1.6 GHz	Up to 8GB	1	1	1 x HDMI 1 x VGA	2	N/A	2 x USB2.0 2 x USB3.0	6Di 2Do	2 x RS-232/422/485 or 2 x CANBus 2.oA.B	2	3 x Full Size 1 x Half Size	2	9 ~ 36 V _{dc}	-20 ~ 60° C
ARK-2151V-S9A1E	Intel i5-4300U 1.9 GHz										N/A				

Packing List

Part Number	Description
-	1 x ARK-2151 Unit
-	1 x Driver/Utility CD/Manual
-	1 x User Manual (Simplified Chinese)
1652000049	3-pole phoenix power block 3.81mm
1750001782	1 x GPS antenna Active with 5M SMA cable
1652003235	10-Pin DIO plug in block

Embedded OS

Part Number	Description
2070013560	ARK-2151V-S6A1E WES7 E OS image
2070013568	ARK-2151V-S9A1E WES7 E OS image
2070013599	ARK-2151V-S6A1E WE8S OS image
2070013600	ARK-2151V-S9A1E WE8S OS image

*Default BIOS is supported for 64-bit OS installation, BIOS 32-bit OS is supported by project

Optional Items

Part Number	Description
96PSA-A120W19T2	AC-to-DC Adapter
1702002600	Power Cable 3-pin 180cm, USA type
1702002605-02	Power Cable 3-pin 183cm, Europe type
1700018704	Power Cable 3-pin 183cm, UK type
AMK-V004E	VESA mounting kit
AMK-R004E	DIN-rail mounting kit